



COVIND

unlimited quality



COVIND COV
IND COVIND
COVIND COV
IND COVIND
COVIND COV
IND COVIND
COVIND COV

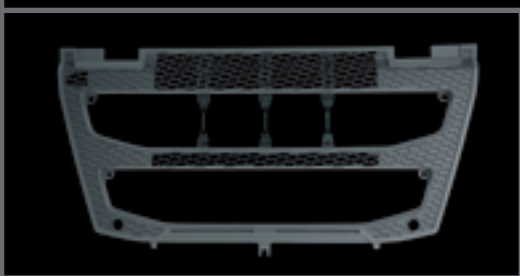

SUITABLE TO

VOLVO
2023







S U I T A B L E T O

VOLVO

GENNAIO
JANUARY
JANUAR

2023



BUREAU
VERITAS

SGS





كافة التفاصيل المذكوره هنا, وبالرغم من قابليتها للتبديل مع التفاصيل الاصليه بشكل متطابق تماما, إلا انها ليست الاصليه, نفس التفاصيل يتم الاستعانه بها واستخدامها فقط للعربات السائره فقط بعد الحصول على التصريح بالموافقه من مالك العربيه التي يتم إصلاحها.
الأرقام الارشاديه الأصلية يتم وضعها بغرض الاستعلام, نرجو أن يتم دائما ذكر أرقامنا الخاصة الارشاديه في التعاقدات وطلبات الشراء.
هذا الكاتالوج بلغي كافة الكاتالوجات السابقه ويحل محلها.



Всички особености изредени по-долу, независимо от това, че са взаимозаменяеми с оригиналите, **не са оригинали**. Те биват използвани само за превозните средства в движение и само след упълномощаване от страна на собственика на превозното средство в ремонт.



Selles nimekirjas olevad varuosad ei ole originaalid vaatamata sellele, **et on originaalidega võrdväärselt kasutatavad**. Neid osasid kasutada ainult töös olevatel sõidukitel ja üksnes remonditava sõiduki omaniku loal. Originaali viitenumbrid on ära toodud ainult infoks. Palume müügi- ja tellimislehtedel ära märkida meie viitenumbrid.
Käesoleva kataloogi nimekiri tühistab ja asendab varasemad.



Tässä luetteloidut varaosat eivät ole alkuperäisosa, vaikka **ne ovatkin laadultaan alkuperäisosa vastaavia**. Osat on tarkoitettu käytettäväksi liikenteessä olevissa autoissa ja niitä käytetään vain korjattavan ajoneuvon omistajan luvalla. Alkuperäiset tuotekoodit mainitaan vain tiedon vuoksi. Pyydämme teitä käyttämään neuvotteluissa ja tilauslomakkeissa meidän tuotekoodejamme. Uusi tuoteluettelo peruuttaa ja korvaa aikaisemmat luettelot.



Toutes les pièces détaillées ci-dessus, tout en étant parfaitement interchangeables avec les pièces d'origine, **ne sont pas originales**. Les mêmes pièces sont utilisées exclusivement sur les véhicules en circulation et seulement sous autorisation du propriétaire du véhicule en réparation. Les codes de référence originales sont indiqués à titre purement documentaire. Dans les négociations et les commandes veuillez bien citer nos codes de référence. Le présent catalogue annule et remplace tous les précédents.



Alle hier aufgeführten Bestandteile sind exakt austauschbar mit den Originalteilen, **aber es sind keine Originale**. Diese Teile werden nur angewendet und eingesetzt für die Fahrzeuge die im Umlauf sind und nur nach Einverständnis mit dem Eigentümer, dessen Fahrzeug in der Reparatur ist. Die Original-Referenznummern wurden rein informativ nochmals wiedergegeben. Bei Anfragen und bei Bestellungen bitten wir Sie immer die Referenznummern anzugeben. Der beigelegte Katalog ersetzt und annulliert die vorhergehenden Kataloge.



Κάθε ανταλλακτικό που απαριθμείται εδώ, ακόμα κι αν όντας τέλεια ανταλλάξιμο με το γνήσιο, **δεν είναι γνήσιο**. Αυτά τα μέρη χρησιμοποιούνται μόνο στα οχήματα που είναι σε κυκλοφορία και αποκλειστικά μετά από την έγκριση του ιδιοκτήτη του οχήματος για επισκευή.

Οι γνήσιοι κωδικοί που αναφέρονται υπάρχουν για πληροφοριακούς λόγους μόνο. Παρακαλούμε όπως χρησιμοποιείτε για οποιαδήποτε συναλλαγή/ παραγγελία σας τους δικούς μας αναφερόμενους κωδικούς. Ο παρών κατάλογος ακυρώνει και αντικαθιστά προηγούμενους.



Spare parts listed here, even though perfectly interchangeable with the original ones, **are not original**. These parts are used only on vehicles in circulation and exclusively under authorization of the owner of the vehicle in repair. The original reference codes are indicated for information only. You are kindly requested to indicate our reference codes in negotiations and order sheets. The present catalogue list cancels and replaces previous ones.



قطعات قید شده در اینجا، با اینکه آنها کاملاً قابل تعویض با قطعات اصلی می باشند، قطعات اصلی نیستند. این قطعات تنها برای خودروهایی که در جریان می باشند (خارج از محل تولید می باشند) مورد استفاده قرار می گیرند و منحصرأ تحت اختیار و نضر مالک خودروی در حال تعمیر می باشند. با احترامات ما از شما شماره کد ارجاع اصلی تنها برای اطلاعات می باشند. تقاضا داریم که شماره کد ارجاع را در زمان مذاکره و در ورقه تقاضا مشخص کنید. لیست



Tutti i particolari qui elencati, pur essendo perfettamente intercambiabili con gli originali, **non sono originali**. Gli stessi vengono impiegati ed utilizzati solo per i veicoli in circolazione e solo dopo autorizzazione da parte del proprietario del veicolo in riparazione. I numeri di riferimento originali sono riportati a puro titolo informativo. Nelle trattative e nelle ordinazioni si prega di voler sempre citare i nostri numeri di riferimento. Il presente catalogo annulla e sostituisce tutti i precedenti.



Kaut arī uzskaitītās rezerves daļas var pilnīgi aizstāt oriģinālās, **tās nav oriģinālas**. Šīs rezerves daļas tiek izmantotas vienīgi apgrozībā esošiem transporta līdzekļiem un tikai ar remontējamā transporta līdzekļa īpašnieka atļauju.

Oriģinālais atsauces numurs tiek uzrādīts vienīgi informācijai.

Lūdzam norādīt jūsu atsauces numurus sarunu laikā un uz pasūtījuma lapas. Šis kataloga saraksts anulē un aizstāj visus iepriekšējos.



Čia išvardytos atsarginės dalys nėra originalios, tačiau jomis galima pakeisti originaliąsias. Šios dalys naudojamos tik apyvartoje esančiuose automobiliuose ir tik gavus remontuojamo automobilio savininko sutikimą.

Originalių dalių kodai nurodomi tik informacijos sumetimais. Maloniai prašome nusiskundimuose ir užsakymų lapuose nurodyti dalių kodus.

Šiame kataloge pateikiamas sąrašas anuliuoja ir pakeičia ankstesniusius.



Reservedelene som er oppført her, er ikke **originale reservedeler**, selv om de fullt ut kan benyttes ved utskiftning av de opprinnelige delene. De skal kun benyttes på kjøretøy som er i bruk og med eierens samtykke. De opprinnelige referansekodene angis kun til etterretning. Vennligst angi våre referansekoder under forhandling og ved bestilling. Denne katalogen annullerer og erstatter alle tidligere kataloger.



Hoewel elk reserveonderdeel dat hier vermeld wordt perfekt kan worden gebruikt in de plaats van de originele stukken, **gaat het hier dus niet om originele onderdelen**. Deze onderdelen worden enkel gebruikt voor voertuigen in circulatie en enkel met de toestemming van de eigenaar van het voertuig dat in reparatie is. De originele referentiecodes worden enkel ter informatie weergegeven. U wordt vriendelijk verzocht om onze referentiecodes te gebruiken in gesprekken en op de bestelformulieren. De huidige catalogoog annuleert en vervangt de vorige versies.



Wszystkie detale tu podane ,choć będąc doskonałe wymienne z oryginałami, **nie są oryginalne**.

Te same zostają zastosowane i użyte tylko dla pojazdów w obiegu i tylko po autoryzacji ze strony właściciela pojazdu będącego w naprawie.

Oryginalne numery referencyjne są umieszczone w celu czysto informacyjnym.

W czasie rozmów handlowych i zamówień, proszę się zechcieć zawsze cytować nasze numery referencyjne.

Niniejszy katalog anuluje i zastępuje wszystkie poprzednie.



Todas as peças aqui listadas, ainda que sejam perfeitamente intercambiáveis com as originais, **não são originais**. Estas peças só são empregues e utilizadas nos veículos em circulação e só após autorização prévia por parte do proprietário do veículo a reparar. Os números de referência originais têm um carácter puramente informativo. Nos contactos e encomendas, indique sempre os números de referência, por favor.



Veškeré zde uvedené součástky **nejsou originální díly**, i když jsou za ně stoprocentně zaměnitelné. Tyto součástky je možné použít pouze pro vozidla v provozu a pouze se souhlasem majitele vozidla, které má být opraveno. Referenční čísla originálních dílů jsou uvedena pouze informativně. Při jednáních a na objednávkách je nutné vždy uvést naše referenční čísla.

Tento katalog anuluje a nahrazuje veškeré předchozí katalogy.



Toate produsele enumerate in continuare, chiar daca sunt perfect interschimbabile cu cele originale, **nu sunt originale**. Ele sunt utilizate, numai pentru autovehiculele in circulatie si exclusiv cu acordul proprietarului autovehiculului de reparat. Codurile originale sunt indicate numai in scop informativ. Cu ocazia tratativelor verbale, cat si a emiterii ordinelor scrise, clientii sunt rugati sa utilizeze codurile noastre (COVIND) ca referinta. Prezentul catalog anuleaza si le inlocuieste pe cele precedente.



Все перечисленные запчасти не являются оригинальными, **хотя могут отлично их заменить**. Эти запчасти используются при ремонте автомобилей только с согласия владельца.

Ссылки на порядковый номер оригинальных запчастей указаны исключительно в ориентировочных целях.

При покупках и заказах рекомендуем указывать НАШИ номера запчастей.

Настоящий каталог аннулирует и заменяет все предыдущие.

Оригинальные ориентировочные номера са изнесени само за ваша информация. При преговори и при поръчки молим винаги да цитирате нашите ориентировочни номера.

Настоящият каталог анулира и замества всички съществуващи до момента.



Ovdje popisani prièuvni dijelovi, èak i kada savršeno zamjenjuju izvorne, **nisu izvorni**. Ti dijelovi mogu se uporabiti jedino na vozilima u cirkulaciji i na temelju izrièitoga odobrenja vlasnika vozila na popravku. Brojevi dijela izvornih dijelova navedeni su samo kao primjer. Najljepše vas molimo da u vašim zahtjevima i narudžbama navedete brojeve dijela.

Sadašnji katalog ukida valjanost svih prethodnih kataloga.



Èeprav jih je možno perfektno izmenjati z originalnimi deli, tukaj navedeni nadomestni deli niso originalni. Te dele se uporabljajo samo v vozilih v prometu in izkljuèno samo pod pogojem, da lastnika vozila v popravilu izda zato dovoljenje. Navedene originalne referenène kode so le informativne. Prosimo vas, da navedite naše referenène kode pri pogajanju in na naroèilih. S sedanjim seznamom prenehajo veljati prejšnji sezname in jih nadomesti.



Todos los elementos detallados a continuación, aunque totalmente intercambiables con los originales, **no son originales**. Estos mismos se emplean y utilizan unicamente para vehículos en circulación y previa autorización del propietario del vehículo en reparación. Los numeros de referencia originales se citan a título informativo. En las negociaciones y en los pedidos se ruega citar siempre nuestros numeros de referencia. El presente catálogo anula y substituye todos los anteriores.



Reservdelarna i denna lista är inte originaldelar trots att de **är fullkomligt utbytbara med de ursprungliga**. Dessa delar används endast på fordon i cirkulation och enbart efter godkännande av ägaren till det fordon som lämnats på reparation. De originala referenskoderna anges endast för information. Var god ange våra referenscodes i negocieringar och beställningsblanketter. Den nuvarande katalogistan annullerar och ersätter de föregående.



Devamında detaylandırılan tüm elementler, orijinalleri ile tamamen değiştirilebilir olmasına rağmen, **orijinal değildirler**. Bunlar, yalnızca dolaşımda bulunan araçlarda ve tamirde bulunan aracın sahibinden ön onay alınması kaydıyla uygulanabilir ve kullanılabilir.

Orijinallerin referans numaraları bilgi başlığında yer almaktadır.

Görüşmelerde ve siparişlerde referans numaralarımızın her zaman belirtilmesi rica olunur.

Bu katalog tüm önceki versiyonları geçersiz kılar ve bunların yerine geçer.



Перелічені тут запасні частини не є оригінальними, але цілком взаємозамінні з оригінальними. Ці запасні частини застосовуються тільки на транспортних засобах, що знаходяться в експлуатації і винятково з дозволу власника, що здав транспортний засіб у ремонт.

Коди оригінальних запасних частин наводяться тільки для довідки. Прохання вказувати довідкові коди запасних частин при веденні переговорів і на бланках замовлення.

Даний каталог скасовує дію раніше виданих каталогів і замінює ці каталоги.



Az itt felsorolt tartalék alkatrészek, még akkor is, ha megfelelően felcserélhetők az eredetiekkel, nem az eredetiek. Ezeket az alkatrészeket csak forgalomban lévő járművek javításánál használják és kizárólag a jármű tulajdonosának engedélyével.

Az eredeti referencia kódokat csak információs célból jelzik. Kérjük legyen szíves jelezze a referencia kódjainkat a tárgyalásokon és a megrendelési dokumentumban.

A jelenlegi katalógus lista vissza van vonva és újra az előző lista van érvényben.

WWW.COVIND.IT



Si consiglia di consultare sempre il catalogo on-line per gli ultimi aggiornamenti.

Please visit the catalogue on-line for the latest updates.

Il est conseillé de toujours consulter le catalogue en ligne pour les dernières mises à jour.

Wir empfehlen Ihnen immer unsere on line Kataloge nachzuschlagen, um die letzten Aktualisierungen zu kennen

Les recomendamos consulten siempre el catálogo en línea para las últimas actualizaciones.

Recomenda-se a consulta do catálogo eletrónico para informação das novas atualizações.

Zaleca się odwiedzać zawsze katalog on-line zawierający najnowsze aktualizacje

E consiliabila intotdeauna, consultarea catalogului on-line pentru cunoasterea ultimilor actualizari.

Пожалуйста, обратите внимание на последние обновления каталогов on-line

للاطلاع على آخر التحديثات،
الرجاء الرجور دائما الى كاتالوجاتنا على الخط.

Index

LEGENDA REAR MIRROR

intro 2-3-4

LEGENDA LIGHTING

intro 5

TABELLE COMPARATIVE :: CROSS REFERENCES :: KORRESPONDENZTABELLE

OEMCOVIND

intro 7

COVINDOEM

intro 19

MEDI.: MEDIUM.: VERTEILERVERKEHR

OFL	FL 2006 (2006→2012)	1
OFE	FE 2006 (2006→2012)	21
4FM	FM euro 6 (2013→)	43
2FM	FM7-FM10-FM12 (2001→2005)	79
0FM	FM7-FM10-FM12 (1998→2001)	111
4HR	FH Euro 6 Restyling	137

PESANTI.: TRUCKS.: NUTZFAHRZEUGE

4FH	FH Euro 6 (2013→)	143
3FH	FH13 (2008→2012)	191
2FH	FH12-FH16 (2002→2007)	245
0FH	FH12-FH16 (1993→2001)	283
V12	F12	317
3FX	FMX euro 5 (2010→2012)	329

Legenda rear mirrors



Guida destra/sinistra
Right and left-hand drive
Rechts-und Linkslenkung



Lato sinistro
Left side
Links einsetzbar



Colore Silver
Color Silver
Farbe Silber



Guida destra
Right-hand drive
Rechtslenkung



Braccio Polipropilene e Fibra di vetro
PP+GF mirror arm
Spiegelarm aus Polypropylen und Glasfaser



Colore Nero e Grigio
Color Black/Grey
Farbe Schwarz/Grau



Guida sinistra
Left-hand drive
Linkslenkung



Braccio integrato
Integrated arm
Integrierten Arm



Raggio 1200 di convessità specchio principale
Mirror glass bend radius: 1200
Wölbungsradius des Spiegelglases 1200



Braccio corto - destro
Short arm - right
Kurzer Spiegelarm, rechts



Braccio in acciaio (ø 28 mm / ø 40 mm)
Steel arm (ø 28 mm / ø 40mm)
Spiegelarm aus Stahl (ø 28 mm / ø 40 mm)



Raggio 300 di convessità specchio ausiliario
Mirror glass bend radius: 300
Wölbungsradius des Weitwinkelspiegelglases 300



Braccio corto - sinistro
Short arm - left
Kurzer Spiegelarm, links



Braccio in alluminio (ø 28 mm / ø 40 mm)
Aluminium arm (ø 28 mm / ø 40 mm)
Spiegelarm aus Aluminium (ø 28 mm / ø 40 mm)



Curvo
Convex
Gewölbtes Glas



Braccio medio - destro
Middle arm - right
Mittlerer Spiegelarm, rechts



Materiale: ABS
Material: ABS
Kunststoff ABS



Classe II: specchio principale
Class II: main mirror
Klasse II: Hauptspiegel



Braccio medio - sinistro
Middle arm - left
Mittlerer Spiegelarm, links



Braccio completo di copribraccio inferiore
Arm with lower cover
kompletter Spiegelarm mit unteren Haltebock



Classe IV: specchio ausiliario
Class IV: auxiliary mirror
Klasse IV: Weitwinkelspiegel



Braccio lungo - destro
Long arm - right
Langer Spiegelarm, rechts



Braccio completo di copribraccio superiore e inferiore
Arm with upper and lower cover
kompletter Spiegelarm mit oberen und unteren Haltebock



Classe III: specchio ausiliario
Class III: auxiliary mirror
Klasse III: Weitwinkelspiegel



Braccio lungo-sinistro
Long arm - left
Langer Spiegelarm, links



Braccio completo di supporto superiore
Arm with upper bracket
kompletter Spiegelarm mit oberen Haltebock



Superiore
Top
Höher



Lato destro/sinistro
Right/left side
Links/rechts einsetzbar



Colore Nero
Color Black
Farbe Schwarz



Centrale
Central
Zentral



Lato destro
Right side
Rechts einsetzbar









Colore Grigio
Color Grey
Farbe Grau



Inferiore
Bottom
Unter

-  Doppio specchio
Double glass
Zweispiegel
-  Regolazione elettrica
Remote control
Elektrisch verstellbar
-  Regolazione manuale
Manual control
Manuell verstellbar
-  Specchio riscaldato 24V (sbrinamento)
Heated 24 V
Spiegel beheizt 24 V (Entfrostung)
-  Specchio riscaldato (sbrinamento)
Heated
Spiegel beheizt (Entfrostung)
-  Braccio con cavo per movimento elettrico
Arm with electric wire
Spiegelarm mit Steuerkabel
-  Braccio con cavo per riscaldamento 24 V
Arm with heat wire 24 V
Spiegelarm mit Heizkabel
-  Sistema di bloccaggio
Blocking System
Haltebock
-  Vetro specchio con supporto
Mirror glass unit
Glas mit Spiegelhalter
-  Ribaltamento elettrico
Electrically foldable
Elektrisch einklappbar

-    Lampeggiatore luce bianca (W)
White light blinker (W)
Blinker weisslicht (W)
-    Lampeggiatore luce arancione (W)
Orange light blinker (W)
Blinker orangelight (W)
-  Sonda
Sensor
Sensor
-  Antenna
Antenna
Antenne
-  Supporto con attacco circolare
Circular attack support
Unterstützung mit Rundangriff
-  Fornito smontato
Unassembled
Zerlegte Lieferung
-  Imballo
Packing
Verpackung
-  Selezionatore specchio destro/sinistro
Mirrors' selector right/left
Spiegelverstellung rechts/links
-  Azionamento alzacristalli
Windows' drive power
Antriebsseite Fensterheber
-  Retroilluminato
Courtesy lighted
Rueckbeleuchtet



- * L'OEM fornisce R400-R1800, COVIND R300-R1200 come da normativa vigente. L'indicazione "*" nel codice OEM ha pertanto il solo scopo di aiutare il cliente nell'identificazione del prodotto Covind equivalente.
- * OE supplies R1800-R400 while COVIND R1200-R300 according to the valid Regulation.
The symbol "*" near the OEM code is used only for comparison purposes helping the customer to properly identify the equivalent item.
- * OEM beliefer R1800-R400 während COVIND liefern in R1200-R300 die Europa normative folgend.
Die Angabe "*" im Original-Referenz dient dazu, dem Kunden zu helfen, den Covind passenden Produkt zu ermitteln.

Normativa . Regulation . Vorschrift

Secondo le direttive:

CE 2003/97 valida dal 01/2007
CE 2007/38 valida da 04/2009

With reference to:

2003/97/EC Regulation valid from January 2007
2007/38/EC Regulation valid from April 2009

Gemäß EG-Verordnung:

2003/97/EC Gültig ab Januar 2007
2007/38/EC Gültig ab April 2009

A Sistema specchio completo (II+IV+Braccio)
 Complete Mirror (Class II+IV+arm)
 Komplettspiegel (Klasse II+IV+Arm)

B Unità specchio (II/IV)
 Mirror unit (Class II/Class IV)
 Spiegeleinheit (Klasse II/IV)

C Componenti di ricambio
 Spare parts
 Ersatzteile

Codice Covind
 Covind code
 Covind Nr.

Codici Originali
 O.E.M. Ref.
 OE Nummer

Posizione Specchio
 Mirror position
 Einsetzung des Spiegels

- Particolare presente in assortimento Covind;
 Item in Covind Range
 Teil in unserer Produktpalette
- Particolare non presente in assortimento Covind
 Item not in Covind Range
 Teil nicht in unserer Produktpalette

Numero di Omologazione
 CE number
 Homologations-Nr.

973/502

A	973/502					
	II	E4 024092		180x425 mm		
	IV	E4 024093		185x192 mm		
applicabilità:		MERCEDES-BENZ Atego II 2004-2010				
applicabile to:		MERCEDES-BENZ Axor II 2004-2010				
Verwendbar für						
B	973/516	0008102179 (0038101579)			215x440 mm	
	II					
	IV					
	973/518	0008102479 (0038101679)			215x198 mm	
	II					
	IV					

973/502

C	973/512	0018109814				375x800 mm
	b	973/505	0018119933			E4 024092 180x425 mm
	II					
	c	973/506	0028110033			E4 024093 185x192 mm
	IV					
	h	973/507	0008112007			

148 . adattabile a :: suitable to :: assend an MERCEDES-BENZ

149

Dimensioni particolare (larghezza x altezza)
 Item dimensions (Width x Height)
 Abmessungen des Teiles (Länge * Höhe)

Legenda lighting



Proiettori
Headlamp
Scheinwerfer



Fendinebbia
Fog lamp
Nebelscheinwerfer



Fanali
Lamp
Beleuchtungen



Catadiottro
Reflex-reflector
Rueckstrahler



Faro supplementare
Spot light
zusätzliche Scheinwerfer



Destro
Right
Einbauort rechts



Sinistro
Left
Einbauort links



Destro | Sinistro
Right | Left
Einbauort rechts | links



Lampadina
Bulb type
Gluehbirne



Omologazione
With E-mark
Homologation



KIT



Correttore assetto manuale
Manual load level adjustment
fuer Fahrzeuge ohne Leuchtweiteregelung



Predisposto per correttore assetto
Suitable for load level adjustment
fuer Fahrzeuge mit Leuchtweiteregelung



Correttore assetto con motorino elettrico
Load level with electrical screw adjustment
fuer Fahrzeuge mit Leuchtweiteregelung (elektrisch)



Correttore assetto senza motorino elettrico
Load level without electrical screw adjustment
fuer Fahrzeuge ohne Leuchtweiteregelung (elektrisch)



Motorino elettrico
Electrical screw adjustment
Elektromotor



Senza motorino elettrico
Electrical screw adjustment
ohne Elektromotor



Con lampadina
With bulb
mit Gluehbirne



Senza lampadina
Without bulb
ohne Gluehbirne



Con fendinebbia
With fog lamp
mit Nebelscheinwerfer



Luce diurna
Day running light
Tagfahrleuchte



Senza portalampada
Without bulb holder
ohne Lampentraeger



Con led
Led type
mit LED



Con cavo
With cable
mit Kabel



Lampeggiatore su specchio retrovisore - luce arancio
Lamp on rear view mirror - amber
Blinklicht auf Rueckspiegel - oranges Licht



Lampeggiatore su specchio retrovisore - luce bianca
Lamp on rear view mirror - colourless
Blinklicht auf Rueckspiegel - weisses Licht



Colore vetro
Lens colour
Glasfarbe



Colore alloggiamento
Housing colour
Gehaeusefarbe



Colore vetro e alloggiamento
Lens and housing colour
Glas- und Gehaeusefarbe



Con cornice
With frame
mit Rahmen



Luce di direzione
Turn light
Blinklicht



Posizione
Position
Einbauort

gallery

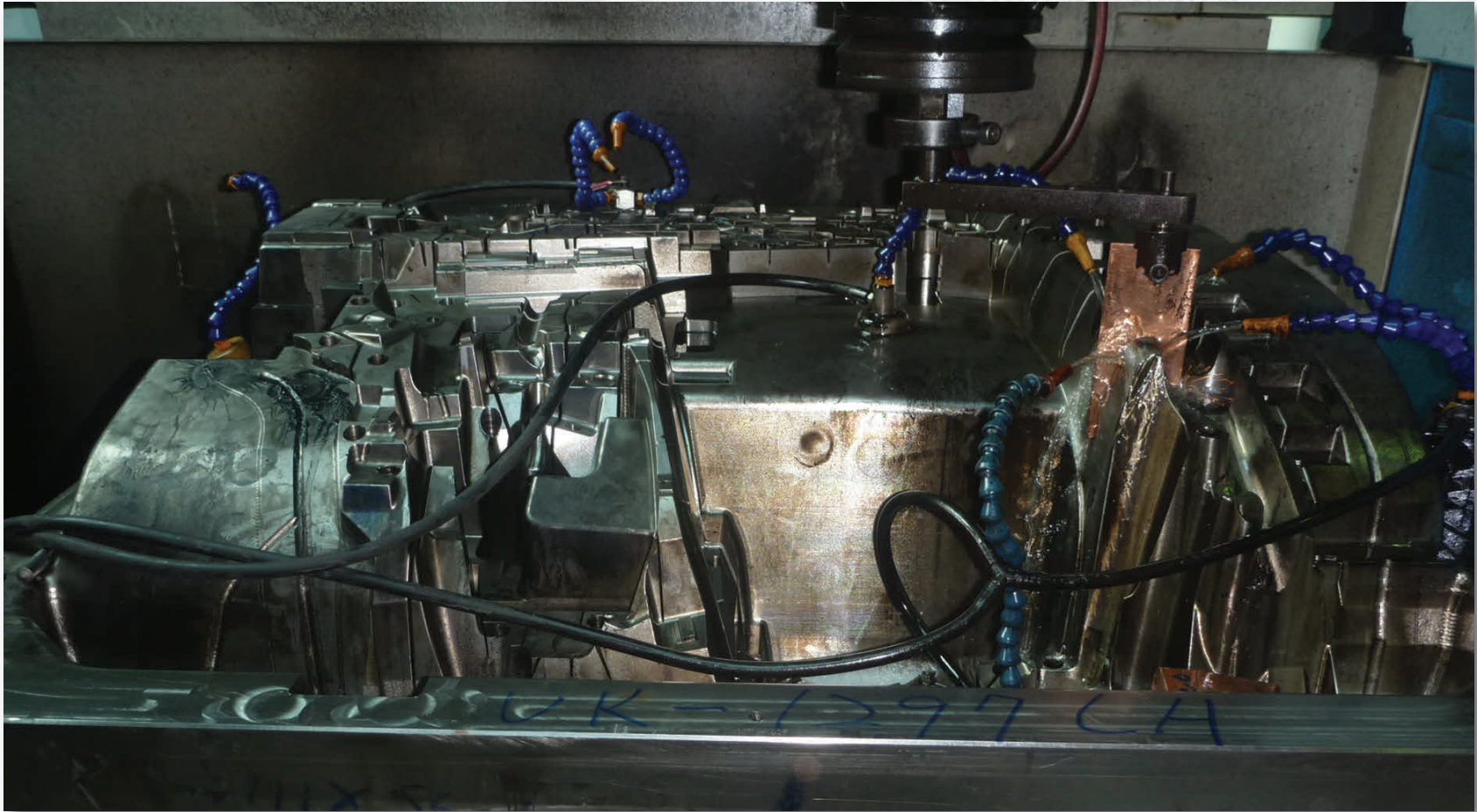

Cod. Originale O.E.M. Ref. OE Nummer	Cod. Covind Covind Ref. Covind Teilnummer	Pag.Cat. Page Cat. Seite
677950	V12/173	323
680662	V12/172	323
680663	V12/171	323
1062133	0FM/241	126
1062134	0FM/240	126
1062163	0FM/135	115
1062190	0FH/650	113,285
1062547	0FH/135	286
1062548	0FH/134	286
1062565	0FH/195	56,98,118,205,261,301,334
1062566	0FH/194	56,98,118,205,261,301,334
1062636	2FH/ 9	203,258,298
1062637	2FH/ 10	203,258,298,335
1063327	0FH/193	203,259,299
1063328	0FH/192	203,259,299
1063509	0FH/150	115,286
1063726	0FM/210	57,100,126,336
1077451	0FH/520	105,133,239,274,311,348
1079965	2FH/515	102,103,130,131,234,235, 270,271,308,309,344,345
1079981	2FH/510	104,132,238,272,310,349
1080926	V12/ 90	318
1082466	V12/174	323
1082467	V12/175	323
1086533	0FH/ 5	301
1086534	0FH/ 4	301
1089967	V12/230	322
1096643	2FH/506	96,124,266,296
1508722	V12/174	323
1508953	V12/113	323
1509937	V12/270	321
1521324	V12/156	320
1570895	V12/180	323
1570896	V12/179	323
1570897	V12/163	323

Cod. Originale O.E.M. Ref. OE Nummer	Cod. Covind Covind Ref. Covind Teilnummer	Pag.Cat. Page Cat. Seite
1570898	V12/162	323
1571117	V12/ 5	322
1571118	V12/ 4	322
1589309	V12/243	325
1591146	V12/800	318
1591558	V12/260	321
1592458	V12/375	320
1593174	V12/257	321
1599297	0FH/510	128,306
1606375	0FH/166	260,300
1607178	V12/271	321
1607898	V12/168	318
1610787	V12/427	320
1610788	V12/426	320
1612331	V12/169	318
1619106	0FH/ 50	290
1619148	0FH/161	290
1619149	0FH/160	290
1619254	0FH/800	289
1619690	0FH/ 5	301
1619691	0FH/ 4	301
1621182	V12/112	319
1621183	V12/111	319
1621184	V12/135	319
1621185	V12/134	319
1621323	V12/157	320
1621324	V12/156	320
1621325	V12/157	320
1621376	V12/155	318
1621903	V12/ 99	319
1621904	V12/ 98	319
1623147	2FH/ 7	203,258,298,335
1623148	2FH/ 6	203,258,298,335
1623459	0FH/320	304
1626679	0FH/ 93	113,284

Cod. Originale O.E.M. Ref. OE Nummer	Cod. Covind Covind Ref. Covind Teilnummer	Pag.Cat. Page Cat. Seite
1626680	0FH/ 92	113,284
1660358	V12/340	321
1661382	V12/343	321
1664215	V12/340	321
1665132	V12/347	321
1676400	2FH/620	-
2143787	4FH/ 87	45,145
3090484	0FH/196	98,118,205,261,301,334
3090971	0FH/134	286
3090972	0FH/135	286
3091750	0FH/513	123,295
3091751	0FH/512	121,293
3092854	0FH/506	121,123,293,295
3127594	2FH/619	39,110,281,316
3171391	2FH/515	102,103,130,131,234,235, 270,271,308,309,344,345
3175029	0FH/190	99,119,204,258,298
3175246	0FH/201	302
3175247	0FH/200	302
3175366	2FH/110	85,197,251,333
3175366	2FH/111	85,197,251,333
3175367	2FH/110	85,197,251,333
3175376	2FM/145	85
3175406	2FH/241	100,212,268,336
3175407	2FH/240	100,212,268,336
3175417	2FH/ 89	83,194,248
3175418	2FH/ 97	83,194,248
3175419	2FH/ 96	83,194,248
3175545	2FH/155	90,255
3175546	2FH/154	90,255
3175547	2FH/157	90,255
3175548	2FH/156	90,255
3175863	0FH/155	115,286
3175918	0FH/195	56,98,118,205,261,301,334
3175919	0FH/194	56,98,118,205,261,301,334

Cod. Originale O.E.M. Ref. OE Nummer	Cod. Covind Covind Ref. Covind Teilnummer	Pag.Cat. Page Cat. Seite
3175927	2FH/201	212,268
3175928	2FH/200	212,268
3175929	2FH/207	212,268
3175930	2FH/206	212,268
3175933	2FH/205	212,268
3175934	2FH/204	212,268
3197850	0FH/522	105,133,237,273,312,347
3197851	0FH/521	105,133,239,274,311,348
3953182	0FH/166	260,300
3980432	2FH/ 3	205,261,301
3980433	2FH/ 2	205,261,301
3980869	0FH/135	286
3980870	0FH/134	286
3981043	0FH/199	268,303
3981256	0FH/ 96	113,284
3981593	0FH/710	116,287
3981666	0FH/610	117,288
3981668	0FH/604	117,288
3981762	0FH/201	302
3981764	0FH/200	302
3987252	2FH/517	102,104,130,132,234,238, 270,272,308,310,344,349
3987253	2FH/514	104,132,238,272,310,349
8122893	0FH/205	302
8122894	0FH/204	302
8140016	0FM/170	7,99,119,204
8140923	0FH/400	291
8141003	0FH/241	303
8141004	0FH/240	303
8141236	0FH/205	302
8141237	0FH/204	302
8141289	0FH/ 95	115,286
8141290	0FH/ 94	115,286
8141312	0FH/243	304
8141313	0FH/242	304

Cod. Originale O.E.M. Ref. OE Nummer	Cod. Covind Covind Ref. Covind Teilnummer	Pag.Cat. Page Cat. Seite
8142043	0FH/193	203,259,299
8142044	0FH/192	203,259,299
8143393	0FH/110	290
8144107	0FH/201	302
8144108	0FH/200	302
8144454	0FH/ 90	113,284
8144455	0FH/145	289
8144482	0FH/150	115,286
8144524	0FH/146	289
8144525	0FH/147	289
8144526	0FH/149	289
8144527	0FH/148	289
8150689	V12/ 90	318
8152722	0FH/ 96	113,284
8154385	0FH/520	105,133,239,274,311,348
8155808	0FH/515	128,129,306,307
8156540	0FH/321	304
8156551	0FH/518	128,129,306,307
8156552	0FH/518	128,129,306,307
8156554	0FH/519	128,129,306,307
8156556	0FH/510	128,306
8158216	V12/ 90	318
8189092	0FH/161	290
8189093	0FH/160	290
8189130	0FH/105	-
8189195	0FH/201	302
8189196	0FH/200	302
8189295	0FH/105	-
8189300	0FH/201	302
8189301	0FH/200	302
8189318	0FH/400	291
8189329	0FH/ 90	113,284
8189337	0FH/ 96	113,284
8189467	0FH/155	115,286
8190106	0FH/515	128,129,306,307

Cod. Originale O.E.M. Ref. OE Nummer	Cod. Covind Covind Ref. Covind Teilnummer	Pag.Cat. Page Cat. Seite
8191103	0FH/215	305
8191104	0FH/212	305
8191105	0FH/210	213,269,305
8191142	0FH/610	117,288
8191220	0FH/110	290
8191313	0FH/215	305
8191314	0FH/212	305
8191315	0FH/210	213,269,305
8191316	0FH/105	-
8191406	0FM/145	114
8191409	0FM/161	114
8191412	0FM/160	114
8191421	0FM/110	114
8191439	0FM/ 50	114
8191570	0FM/134	115
8191593	0FM/241	126
8191594	0FM/240	126
8191778	0FM/207	126,337
8191779	0FM/206	126,337
8191780	0FM/199	127,337
8191781	0FM/198	127,337
9520400	0FH/670	110,281,316,324
20360266	2FH/145	250
20360273	0FH/721	285
20360274	0FH/720	285
20360507	0FH/145	289
20360542	2FH/ 3	205,261,301
20360543	2FH/ 2	205,261,301
20360788	2FH/209	57,100,213,269,336
20360789	2FH/208	57,100,213,269,336
20360810	2FH/502	93,95,263,265
20360811	2FH/508	93,95,263,265
20360849	2FM/ 3	98,118,334
20360850	2FM/ 2	98,118,334
20360898	2FH/605	88,254

Cod. Originale O.E.M. Ref. OE Nummer	Cod. Covind Covind Ref. Covind Teilnummer	Pag.Cat. Page Cat. Seite
20360899	2FH/604	88,254
20372037	2FH/ 7	203,258,298,335
20372038	2FH/ 6	203,258,298,335
20372039	2FH/ 10	203,258,298,335
20372064	2FH/317	269
20372065	2FH/316	269
20372226	0FH/ 93	113,284
20372227	0FH/ 92	113,284
20375489	2FH/527	106,276
20375540	2FH/522	106,276
20379171	2FM/161	89,333
20379172	2FM/160	89,333
20379175	2FH/161	196,250
20379176	2FH/160	196,250
20379348	2FH/ 50	197,251,333
20379349	2FM/ 50	85
20379357	2FH/163	89,196,250,333
20379358	2FH/162	89,196,250,333
20379437	0FH/215	305
20379438	0FH/212	305
20379439	0FH/210	213,269,305
20379593	0FH/191	259,299
20382890	0FH/526	237,273,312,347
20383038	0FH/527	237,273,312,347
20383543	2FH/111	85,197,251,333
20392544	2FH/505	102,103,105,130,131,133, 234,235,237,270,271,273, 275,308,309,313,344,345, 346,347
20392599	2FH/518	102,103,130,131,234,235, 270,271,275,308,309,313, 344,345,346
20398135	2FH/ 7	203,258,298,335
20398136	2FH/ 6	203,258,298,335
20398385	0FH/135	286

Cod. Originale O.E.M. Ref. OE Nummer	Cod. Covind Covind Ref. Covind Teilnummer	Pag.Cat. Page Cat. Seite
20398386	0FH/134	286
20398387	0FM/135	115
20398388	0FM/134	115
20398389	0FM/135	115
20398390	0FM/134	115
20398466	0FH/195	56,98,118,205,261,301,334
20398467	0FH/194	56,98,118,205,261,301,334
20398707	2FH/ 85	81,193,247
20398708	2FH/ 84	81,193,247
20398709	2FH/ 80	81,193,247
20398907	0FH/ 5	301
20398908	0FH/ 4	301
20409818	2FH/152	89,256
20409874	2FH/607	87,253
20409875	2FH/606	87,253
20425418	2FH/137	87,253
20425419	2FH/136	87,253
20425625	2FH/ 90	82,194,248
20425626	2FH/ 93	82,194,248
20425627	2FH/ 92	82,194,248
20429679	2FH/ 80	81,193,247
20429680	2FH/ 85	81,193,247
20429681	2FH/ 84	81,193,247
20452847	2FH/133	86,252
20452848	2FH/132	86,252
20452886	2FH/135	86,252
20452887	2FH/134	86,252
20453627	2FH/ 99	87,253
20453628	2FH/ 98	87,253
20453676	2FH/237	81,193,247
20453677	2FH/236	81,193,247
20453678	2FH/237	81,193,247
20453679	2FH/236	81,193,247
20453690	3FH/ 85	90,198,255
20453716	2FH/150	86,252

Cod. Originale O.E.M. Ref. OE Nummer	Cod. Covind Covind Ref. Covind Teilnummer	Pag.Cat. Page Cat. Seite
20453900	2FH/325	269,337
20453930	2FH/ 95	87,253
20453931	2FH/ 94	87,253
20455995	2FH/504	93,95,263,265
20456550	2FH/100	193,247
20456709	2FH/400	91,257
20456804	2FH/ 86	84,195,249
20456805	2FH/ 88	84,195,249
20456806	2FH/ 87	84,195,249
20456963	2FH/153	89,256
20466894	0FH/522	105,133,237,273,312,347
20466895	0FH/521	105,133,239,274,311,348
20467037	2FH/ 5	205,261
20467038	2FH/ 4	205,261
20467053	2FH/115	251
20467142	2FH/143	-
20467143	2FH/142	-
20467412	2FH/480	91,257
20467414	2FH/480	91,257
20467422	2FH/480	91,257
20467424	2FH/480	91,257
20467442	2FH/100	193,247
20498620	2FH/513	104,132,238,272,310,349
20501225	0FE/400	2,22
20507020	2FH/ 95	87,253
20507021	2FH/ 94	87,253
20507252	2FH/619	39,110,281,316
20514389	2FH/515	102,103,130,131,234,235, 270,271,308,309,344,345
20516776	2FH/150	86,252
20527443	2FH/410	91,257
20528503	2FH/149	256
20528507	2FH/148	256
20529638	2FH/241	100,212,268,336
20529640	2FH/240	100,212,268,336

Cod. Originale O.E.M. Ref. OE Nummer	Cod. Covind Covind Ref. Covind Teilnummer	Pag.Cat. Page Cat. Seite
20529668	2FH/163	89,196,250,333
20529672	2FH/162	89,196,250,333
20529682	2FH/205	212,268
20529684	2FH/204	212,268
20529705	2FH/155	90,255
20529706	2FH/154	90,255
20529707	2FH/157	90,255
20529708	2FH/156	90,255
20529738	2FH/111	85,197,251,333
20529740	2FH/ 89	83,194,248
20529741	2FH/ 97	83,194,248
20529742	2FH/ 96	83,194,248
20529765	0FH/199	268,303
20530082	0FM/207	126,337
20530083	0FM/206	126,337
20530146	2FH/110	85,197,251,333
20534600	2FH/ 99	87,253
20534601	2FH/ 98	87,253
20541447	3FH/619	-
20545094	2FH/149	256
20545095	2FH/148	256
20567685	2FH/504	93,95,263,265
20570721	2FH/191	99,203,259,299,335
20570722	2FH/190	99,203,259,299,335
20583434	2FH/513	104,132,238,272,310,349
20583440	2FH/514	104,132,238,272,310,349
20588325	2FH/181	203,259,299,335
20588326	2FH/180	203,259,299,335
20589788	2FH/503	53,55,93,95,207, 209,263,265
20589798	3FH/509	53,55,207,209
20703186	0FH/675	39,77,110,134,187, 244,281,316
20711859	2FH/ 80	81,193,247
20711860	2FH/ 85	81,193,247

Cod. Originale O.E.M. Ref. OE Nummer	Cod. Covind Covind Ref. Covind Teilnummer	Pag.Cat. Page Cat. Seite
20711861	2FH/ 84	81,193,247
20713720	2FH/605	88,254
20713721	2FH/604	88,254
20716956	3FH/514	97,210
20722652	2FH/515	102,103,130,131,234,235, 270,271,308,309,344,345
20722654	2FH/520	102,103,130,131,234,235, 270,271,308,309,344,345
20723526	2FH/515	102,103,130,131,234,235, 270,271,308,309,344,345
20743944	0FL/400	3,23
20746401	2FH/502	93,95,263,265
20746402	3FH/511	53,55,207,209
20762993	2FH/604	88,254
20762994	2FH/605	88,254
20763003	2FH/602	88,254
20763004	2FH/603	88,254
20789440	2FH/610	78,101,186,241,280,350
20826211	2FH/607	87,253
20826213	2FH/606	87,253
20826227	2FH/137	87,253
20826231	2FH/136	87,253
20827042	2FH/ 99	87,253
20827044	2FH/ 98	87,253
20841436	3FH/508	53,55,207,209
20854564	0FH/506	121,123,293,295
20854644	2FH/506	96,124,266,296
20861573	2FH/603	88,254
20861574	2FH/602	88,254
20861583	2FH/605	88,254
20861584	2FH/604	88,254
20896946	0FH/670	110,281,316,324
20917957	2FH/ 99	87,253
20917958	2FH/ 98	87,253
20926021	0FH/675	39,77,110,134,187,244,

Cod. Originale O.E.M. Ref. OE Nummer	Cod. Covind Covind Ref. Covind Teilnummer	Pag.Cat. Page Cat. Seite
		281,316
20936759	2FH/515	102,103,130,131,234,235, 270,271,308,309,344,345
20936769	2FH/520	102,103,130,131,234,235, 270,271,308,309,344,345
20937431	0FE/400	2,22
20937442	0FL/400	3,23
21001645	2FH/603	88,254
21001649	2FH/602	88,254
21001663	2FH/605	88,254
21001668	2FH/604	88,254
21023794	2FH/155	90,255
21023797	2FH/154	90,255
21023801	2FH/157	90,255
21023802	2FH/156	90,255
21035690	3FH/700	201
21035692	3FH/701	201
21035700	3FH/702	201
21035701	3FH/703	201
21058445	2FH/145	250
21070768	3FH/509	53,55,207,209
21075528	0FH/675	39,77,110,134,187, 244,281,316
21075529	0FH/675	39,77,110,134,187, 244,281,316
21075530	0FH/675	39,77,110,134,187, 244,281,316
21078543	3FH/137	202
21078545	3FH/136	202
21090272	2FH/528	74,182,239
21094383	3FH/530	66,67,68,69,174,175,176, 177,226,227,228,229
21094386	3FH/540	164,165,166,167,168,169, 214,215,216,217,218,219, 338,339,340,341

Cod. Originale O.E.M. Ref. OE Nummer	Cod. Covind Covind Ref. Covind Teilnummer	Pag.Cat. Page Cat. Seite
21094387	3FH/530	66,67,68,69,174,175,176, 177,226,227,228,229
21094388	3FH/520	60,61,62,63,64,65,170,171, 172,173,220,221,222,223, 224,225,342,343
21094389	3FH/535	70,71,72,73,178,179,180, 181,230,231,232,233
21094390	3FH/540	164,165,166,167,168,169, 214,215,216,217,218,219, 338,339,340,341
21094391	3FH/515	60,61,62,63,66,67,70,71, 74,164,165,166,167,170, 171,174,175,178,179,214, 215,216,217,220,221,222, 223,226,227,230,231,236, 338,339,340,341,342,343, 346
21094392	3FH/522	64,65,68,69,72,73,74,168, 169,172,173,176,177,180, 181,218,219,224,225,228, 229,232,233,236
21094393	3FH/523	64,65,68,69,72,73,74,168, 169,172,173,176,177,180, 181,218,219,224,225,228, 229,232,233,236
21094394	3FH/525	62,63,64,65,66,67,68,69, 70,71,72,73,74,166,167, 168,169,170,171,172,173, 174,175,176,177,178,179, 180,181,216,217,218,219, 222,223,224,225,226,227, 228,229,230,231,232,233, 236,340,341,342,343,346
21094400	3FH/525	62,63,64,65,66,67,68,69, 70,71,72,73,74,166,167,

Cod. Originale O.E.M. Ref. OE Nummer	Cod. Covind Covind Ref. Covind Teilnummer	Pag.Cat. Page Cat. Seite
		168,169,170,171,172,173, 174,175,176,177,178,179, 180,181,216,217,218,219, 222,223,224,225,226,227, 228,229,230,231,232,233, 236,340,341,342,343,346
21094406	3FH/517	59,183,240
21094410	3FH/528	74,236
21094411	3FH/527	74,236
21094413	3FH/532	74,236,346
21094447	3FH/524	60,61,164,165,214,215, 220,338,339
21094454	3FH/526	61,74,165,215,236,339
21094456	3FH/526	61,74,165,215,236,339
21094457	3FH/510	60,62,64,66,68,70,72,164, 166,168,170,172,174,176, 178,180,214,216,218,220, 222,224,226,228,230,232, 338,340,342
21106301	0FH/675	39,77,110,134,187, 244,281,316
21123489	3FH/602	200
21123523	3FH/603	200
21169974	3FH/511	53,55,207,209
21190825	3FH/140	196
21203311	0FH/507	121,123,293,295
21213202	2FH/526	74,182,239
21221129	4FH/606	49,153
21221130	4FH/607	49,153
21221133	4FH/600	49,152
21221134	4FH/601	49,152
21221145	4FH/608	49,153
21221146	4FH/609	49,153
21221151	4FH/708	50,155
21221152	4FH/709	50,155

Cod. Originale O.E.M. Ref. OE Nummer	Cod. Covind Covind Ref. Covind Teilnummer	Pag.Cat. Page Cat. Seite
21221153	4FH/702	50,155
21221154	4FH/703	50,155
21221155	4FH/700	155
21221156	4FH/701	155
21221157	4FH/704	155
21221158	4FH/705	155
21221159	4FH/706	155
21221160	4FH/707	155
21261274	2FH/181	203,259,299,335
21261275	2FH/180	203,259,299,335
21281403	0FH/675	39,77,110,134,187, 244,281,316
21297904	3FH/702	201
21297905	3FH/703	201
21297909	3FH/700	201
21297911	3FH/701	201
21297917	3FH/704	201
21297918	3FH/705	201
21299955	2FH/ 5	205,261
21300059	2FH/ 4	205,261
21302461	2FH/207	212,268
21302470	2FH/206	212,268
21305345	3FH/522	64,65,68,69,72,73,74,168, 169,172,173,176,177,180, 181,218,219,224,225,228, 229,232,233,236
21305346	3FH/523	64,65,68,69,72,73,74,168, 169,172,173,176,177,180, 181,218,219,224,225,228, 229,232,233,236
21316575	4FH/ 93	45,145
21316576	4FH/ 90	45,145
21316577	4FH/ 92	45,145
21320300	2FH/504	93,95,263,265
21320365	3FH/509	53,55,207,209

Cod. Originale O.E.M. Ref. OE Nummer	Cod. Covind Covind Ref. Covind Teilnummer	Pag.Cat. Page Cat. Seite
21320404	2FH/503	53,55,93,95,207, 209,263,265
21344647	4FH/243	161
21344649	4FH/242	161
21346521	4FH/427	154
21346522	4FH/426	154
21358670	2FH/150	86,252
21359080	2FH/ 90	82,194,248
21359082	2FH/ 93	82,194,248
21359090	2FH/ 92	82,194,248
21359257	2FH/ 95	87,253
21359260	2FH/ 94	87,253
21392183	4FH/243	161
21392187	4FH/242	161
21404042	3FX/131	331
21404043	3FX/130	331
21413732	4FH/255	162
21413734	4FH/127	48,154
21413763	4FH/250	162
21413774	4FH/126	48,154
21413786	4FH/ 88	45,145
21413789	4FH/ 89	45,145
21425186	3FH/ 85	90,198,255
21430596	2FH/150	86,252
21430598	2FH/137	87,253
21430599	2FH/ 86	84,195,249
21430600	2FH/ 88	84,195,249
21430672	2FH/ 87	84,195,249
21445302	3FH/150	198
21445754	3FH/151	198
21448885	3FH/609	202,331
21451000	3FH/ 95	200
21451002	3FH/ 94	200
21469918	2FH/135	86,252
21469924	2FH/134	86,252

Cod. Originale O.E.M. Ref. OE Nummer	Cod. Covind Covind Ref. Covind Teilnummer	Pag.Cat. Page Cat. Seite
21469979	2FH/136	87,253
21478751	3FH/608	202,331
21478755	3FH/134	200
21478759	3FH/135	200
21484901	2FH/100	193,247
21495266	4FH/ 97	146
21495267	4FH/ 95	146
21495268	4FH/ 96	146
21505893	2FH/181	203,259,299,335
21505894	2FH/180	203,259,299,335
21520015	4FM/241	57
21520119	4FM/240	57
21608661	4FH/604	50,153
21608663	4FH/605	50,153
21608666	4FH/602	152
21608667	4FH/603	152
21642377	4FH/ 5	162
21642399	4FH/ 4	162
21828914	2FH/ 80	81,193,247
21829051	2FH/ 85	81,193,247
21829052	2FH/ 84	81,193,247
21838943	4FH/ 80	44,144
21838944	4FH/ 85	44,144
21838945	4FH/ 84	44,144
21874450	4FH/135	151
21874457	4FH/134	151
21940892	4FH/251	162
22087684	3FH/515	60,61,62,63,66,67,70,71, 74,164,165,166,167,170, 171,174,175,178,179,214, 215,216,217,220,221,222, 223,226,227,230,231,236, 338,339,340,341,342,343, 346
22087701	3FH/522	64,65,68,69,72,73,74,168,

Cod. Originale O.E.M. Ref. OE Nummer	Cod. Covind Covind Ref. Covind Teilnummer	Pag.Cat. Page Cat. Seite
		169,172,173,176,177,180, 181,218,219,224,225,228, 229,232,233,236
22087703	3FH/523	64,65,68,69,72,73,74,168, 169,172,173,176,177,180, 181,218,219,224,225,228, 229,232,233,236
22105756	0FH/650	113,285
22192007	3FH/528	74,236
22192010	3FH/527	74,236
22192015	3FH/532	74,236,346
22239217	4FH/606	49,153
22239219	4FH/607	49,153
22239220	4FH/600	49,152
22239221	4FH/601	49,152
22239225	4FH/604	50,153
22239226	4FH/605	50,153
22239248	4FH/608	49,153
22239250	4FH/609	49,153
22245579	4HR/ 95	140
22247766	4HR/ 80	138,144
22249883	4HR/ 90	139
22286149	3FH/505	54,208
22286155	3FH/504	52,206
22332592	4FH/708	50,155
22332593	4FH/709	50,155
22332594	4FH/702	50,155
22332595	4FH/703	50,155
22332596	4FH/700	155
22332597	4FH/701	155
22332598	4FH/704	155
22332600	4FH/705	155
22332603	4FH/706	155
22332604	4FH/707	155
22766194	4HR/ 89	139

Cod. Originale O.E.M. Ref. OE Nummer	Cod. Covind Covind Ref. Covind Teilnummer	Pag.Cat. Page Cat. Seite
22766195	4HR/ 88	139
22766199	4HR/ 89	139
22766200	4HR/ 88	139
22671460	4HR/ 96	140
22671508	4HR/ 97	140
22773913	4HR/102	140
23311945	4FH/ 9	159
23311948	4FH/ 8	159
23386781	4FH/136	48,154
23386782	4FH/138	48,154
23462387	4FH/121	157
23462398	4FH/122	157
23526465	4HR/135	141
23526802	4HR/134	141
78629519	4FM/157	47,150
82052484	3FH/ 95	200
82056727	3FH/140	196
82056840	3FH/150	198
82056991	3FH/ 94	200
82060441	3FH/149	199
82060445	3FH/148	199
82062209	3FH/157	198
82063513	3FH/154	199
82063911	3FH/156	198
82065607	3FH/150	198
82066238	3FH/ 97	202
82066335	3FH/ 96	202
82072463	3FH/152	199
82076158	3FH/135	200
82076266	3FH/134	200
82090257	3FH/151	198
82090731	4FH/ 89	45,145
82090733	4FH/ 87	45,145
82090735	4FH/ 88	45,145
82101910	4FH/105	146

Cod. Originale O.E.M. Ref. OE Nummer	Cod. Covind Covind Ref. Covind Teilnummer	Pag.Cat. Page Cat. Seite
82101912	4FH/102	146
82101914	4FH/104	146
82107271	4FH/ 5	162
82110404	4FH/ 67	163
82110547	4FH/506	160
82114500	3FH/610	202,331
82114502	3FH/608	202,331
82114504	3FH/609	202,331
82114506	3FH/611	202,331
82131055	4FH/410	158
82136982	4FH/245	161
82141521	4FH/244	161
82141524	4FH/ 66	163
82141971	4FH/241	161
82142373	4FH/240	161
82151157	4FH/138	48,154
82151205	4FH/136	48,154
82155978	4FH/ 41	151
82155980	4FH/ 40	151
82166469	4FH/400	158
82171603	4FH/209	161
82177794	4FH/154	149
82178247	4FH/ 4	162
82180201	4FH/250	162
82180491	4FH/151	149
82181355	4FH/255	162
82186579	4FH/149	148
82187116	4FH/148	148
82208510	4FH/155	149
82208510	4FH/156	148
82208512	4FH/152	149
82209788	3FH/ 99	200
82209849	3FH/ 98	200
82213089	4FH/ 42	157
82215391	3FH/143	196,250

Cod. Originale O.E.M. Ref. OE Nummer	Cod. Covind Covind Ref. Covind Teilnummer	Pag.Cat. Page Cat. Seite
82215401	3FH/142	196,250
82217687	4FH/108	147
82219161	4FH/145	157
82220161	4FH/152	149
82220206	4FH/155	149
82232959	4FH/ 43	157
82255346	4FH/156	148
82258426	4FH/153	148
82266039	3FX/ 43	332
82266040	3FX/ 42	332
82266404	3FX/132	331
82266415	3FX/135	332
82266416	3FX/134	332
82285617	4FH/131	48,154
82298407	4FH/558	150
82298483	4FH/556	150
82298657	4FH/555	150
82304585	3FH/602	200
82304599	3FH/603	200
82319029	4FH/ 9	159
82319253	4FH/ 8	159
82320176	4FH/143	156
82320177	4FH/142	156
82328081	4FH/202	162
82328082	4FH/203	162
82355678	3FH/611	202,331
82360122	4FH/140	157
82367098	3FH/ 99	200
82367957	3FH/ 98	200
82409793	4FM/147	47
82410206	4FM/146	47
82423778	3FX/ 99	332
82424434	3FX/ 98	332
82426186	4FM/129	48
82426187	4FM/128	48

Cod. Originale O.E.M. Ref. OE Nummer	Cod. Covind Covind Ref. Covind Teilnummer	Pag.Cat. Page Cat. Seite
82430056	4FM/125	51
82430057	4FM/124	51
82439937	4FM/108	51
82444204	4FM/149	46
82446592	4FH/125	48,154
82448104	4FM/109	51
82448110	4FM/110	51
82453926	4FH/124	48,154
82454671	4FM/148	46
82454672	4FM/151	46
82455156	4FM/153	46
82462702	4FH/129	151
82462703	4FH/128	151
82491903	4FH/150	148
82610342	4FM/205	58
82610343	4FM/204	58
82610858	4FM/205	58
82610859	4FM/204	58
82637695	3FH/323	58,213
82653837	4FM/204	58
82653839	4FM/205	58
82674760	4HR/105	140
82674762	4HR/104	140
82819477	4FH/204	161
82819482	4FH/205	161
82835554	4FH/107	147
82835601	4FH/106	147
82846116	4FH/109	157
82846118	4FH/110	157
82857748	4FH/158	156
82857758	4FH/157	156
82858486	4FH/122	157
82858516	4FH/121	157
82859306	4FH/208	161
82868625	4FH/324	58,163

Cod. Originale O.E.M. Ref. OE Nummer	Cod. Covind Covind Ref. Covind Teilnummer	Pag.Cat. Page Cat. Seite
82694421	4HR/ 85	138
82694422	4HR/ 84	138
82871739	4FH/108	147
82884080	4FH/137	151
82884084	4FH/139	151
82928883	4FH/ 99	44,144
82943981	4FH/ 98	44,144
84004929	4FH/506	160
84007259	3FH/323	58,213
84013223	4FH/ 40	151
84013224	4FH/ 41	151
84014254	4FH/410	158
84027783	4FM/133	48
84028392	4FM/132	48
84033228	4FH/145	157
84034942	4FH/128	151
84034945	4FH/129	151
84038586	4HR/102	140
84046776	4FH/132	48,154
84049560	4FH/150	148
84055530	4FH/108	147
84058023	4FH/131	48,154
84096588	4FH/203	162
84096589	4FH/202	162
84104142	4FM/157	47,150
84104144	4FM/156	47,150
84106936	4FH/324	58,163
84139886	4FH/129	151
84139933	4FH/128	151
84139937	3FH/611	202,331
84151777	4FM/112	51
84151824	4FM/111	51
84160721	4FH/324	58,163
84160723	4FH/324	58,163
84162402	4FM/120	47

Cod. Originale O.E.M. Ref. OE Nummer	Cod. Covind Covind Ref. Covind Teilnummer	Pag.Cat. Page Cat. Seite
84167321	4FH/506	160
84167413	4FM/121	47
84172098	4FH/ 87	45,145
84195623	4HR/ 87	139
84205718	4HR/ 92	139
84228539	4FH/147	156
84228541	4FH/146	156
84233571	4FH/250	162
84233646	4HR/ 99	141
84234669	4HR/ 98	141
84448715	4HR/434	141
84448796	4HR/135	141
84448800	4HR/134	141
84449120	4HR/435	141
84575369	4FH/558	150
1083666-6	V12/155	318
1089122-4	V12/ 99	319
1089123-2	V12/ 98	319
1509510-2	V12/214	324
1509511-0	V12/212	324
1509799-1	V12/250	321
1509801-5	V12/251	321
1509805-6	V12/252	321
1509846-0	V12/242	322
1509922-9	V12/211	322
1509924-5	V12/210	322
1509945-0	V12/230	322
1517957-5	V12/108	318
1570986-8	V12/316	325
1578428-3	V12/231	322
158612-6	V12/244	325
1586120-6	V12/244	325
1586124-4	V12/243	325
1588723-5	V12/105	320
1588740-9	V12/216	324

Cod. Originale O.E.M. Ref. OE Nummer	Cod. Covind Covind Ref. Covind Teilnummer	Pag.Cat. Page Cat. Seite
1588741-7	V12/215	324
1594077-8	V12/248	321
1607094-8	V12/370	320
1611178-3	V12/100	319
1612621-1	V12/ 75	322
1612622-9	V12/ 74	322
1614428-9	V12/103	320
1614429-7	V12/102	320
1614456-0	V12/ 85	322
1614457-8	V12/ 84	322
1614458-6	V12/ 87	322
1614459-4	V12/ 86	322
1614460-2	V12/ 83	322
1614461-0	V12/ 82	322
1614490-9	V12/246	325
1614589-8	V12/317	325
1621181-5	V12/160	318
1623888-3	V12/200	324
1696262-3	V12/104	320
1697967-6	V12/ 7	322
1697968-4	V12/ 6	322
1697976-7	V12/110	320
1698144-1	V12/157	320
1698145-8	V12/156	320
1698146-6	V12/135	319
1698147-4	V12/134	319
1698650-7	V12/ 3	322
1698651-5	V12/ 2	322
(82053690+ 169898-01)	3FH/ 99	200
(82056986+ 169898-02)	3FH/ 98	200
-	0FH/144	289
-	0FH/197	56,98,118,205,261,301,334
-	0FH/198	56,98,118,205,261,301,334

Cod. Originale O.E.M. Ref. OE Nummer	Cod. Covind Covind Ref. Covind Teilnummer	Pag.Cat. Page Cat. Seite
-	0FH/508	120,292
-	0FH/509	122,294
-	0FM/174	56,99,119,204,260,300,334
-	0FM/175	56,99,119,204,260,300,334
-	2FH/110	85,197,251,333
-	2FH/111	85,197,251,333
-	2FH/500	92,262
-	2FH/501	94,264
-	3FH/502	92,262
-	3FH/503	94,264
-	3FH/506	52,206
-	3FH/507	54,208
-	3FH/815	60,61,164,165,214, 215,338,339
DAF		
20707874	*LF0/503	14,36
20707881	*LF0/501	10,32
20708303	*LF0/502	12,34
20743983	*LF0/500	8,30
20832787	LF0/ 2	6,27
20832788	LF0/ 3	6,27
20862779	LF0/506	9,11,13,15,31,33,35,37
20862800	LF0/507	9,11,13,15,31,33,35,37
20862810	*LF0/505	11,15,33,37
20862815	LF0/504	9,13,31,35
20903723	*LF0/509	15,37
20903732	LF0/508	13,35
21326527	*LF0/500	8,30
21475603	*LF0/502	12,34
85112766	LF0/ 3	6,27
85112767	LF0/ 2	6,27
-	LF0/510	8,12,30,34
-	*LF0/511	10,14,32,36
-	LF0/512	8,12,30,34
-	*LF0/513	10,14,32,36

Cod. Originale O.E.M. Ref. OE Nummer	Cod. Covind Covind Ref. Covind Teilnummer	Pag.Cat. Page Cat. Seite
-	XF0/670	20,39,77,110,187,244, 281,316,324
MERCEDES		
1189577	943/670	110,187,244,281,316,324
20392752	943/670	110,187,244,281,316,324
RENAULT		
1079959	PRM/497	275,313,346
3112654	PRM/700	78,108,109,134,135,186, 278,279,314,315,351
3988730	PRM/700	78,108,109,134,135,186, 278,279,314,315,351
20498623	PRM/515	104,132,238,272,310,349
20538003	MDL/240	4
20538006	MDL/241	4
20538011	385/212	4,26
20538012	385/213	4,26
20538247	385/217	26
20538248	385/216	26
20555722	385/ 7	6,27
20555723	385/ 6	6,27
20557552	385/165	7,28
20557552	385/175	7,28
20557554	385/164	7,28
20557554	385/174	7,28
20593721	PRM/243	25
20593735	PRM/242	25
20707812	MDL/508	16,38
20708110	*PRM/513	11,15,33,37
20708230	*PRM/512	9,13,31,35
20721840	PRM/510	104,132,238,272,310,349
20765181	PRM/235	25,26
20769775	PRM/631	107
20769776	PRM/630	107
20769777	PRM/632	107
20819179	385/480	3,23

Cod. Covind Covind Ref. Covind Teilnummer	Cod. Originale O.E.M. Ref. OE Nummer	Pag.Cat. Page Cat. Seite
20819613	PRM/ 98	24
20819616	PRM/ 99	24
20839504	PRM/120	-
20842821	PRM/619	77,187,244
20842848	PRM/620	77,187,244
20843281	385/494	42
20843281	PRM/496	275,313
20843284	385/495	42
20862795	*PRM/504	9,11,13,15,31,33,35,37
20903722	*PRM/509	11,33
20903727	*PRM/508	9,31
20947987	MDL/619	20,39
21011688	385/494	42
21011689	385/495	42
21087113	PRM/235	25,26
21412897	PRM/620	77,187,244
21924923	PRM/620	77,187,244
21924924	PRM/619	77,187,244
22189860	385/175	7,28
22189861	385/174	7,28
22709903	PRM/700	78,108,109,134,135,186, 278,279,314,315,351
23354972	RRT/632	75,184
23354973	RRT/630	75,184
23354974	RRT/631	75,184
23417997	PRM/620	77,187,244
23417998	PRM/619	77,187,244
23522307	RRT/635	76,185
23522308	RRT/634	76,185
24426873	385/195	6,27
24426875	385/194	6,27
25369341	PRM/105	24
25369342	PRM/104	24
25369343	PRM/103	24
78493162	MDL/508	16,38

Cod. Covind Covind Ref. Covind Teilnummer	Cod. Originale O.E.M. Ref. OE Nummer	Pag.Cat. Page Cat. Seite
81422332	RRT/650	76,185
82317468	PRM/ 99	24
82317469	PRM/ 98	24
82497191	385/167	7,28
82497192	385/166	7,28
82497193	385/165	7,28
82497193	385/175	7,28
82497194	385/164	7,28
82497194	385/174	7,28
82849905	RRT/645	75,184
82849926	RRT/645	75,184
82912803	PRM/120	-
84531138	MDL/508	16,38
84561115	MDL/508	16,38
84561609	385/165	7,28
84561609	385/175	7,28
84561621	385/164	7,28
84561621	385/174	7,28
5010225181	385/210	25
5010225398	385/215	4,25
5010544527	385/215	4,25
5010578381	PRM/245	26
5010578387	PRM/244	26
5010578392	PRM/245	26
5010578882	PRM/244	26
7420947987	MDL/619	20,39
-	*PRM/522	9,13,31,35
-	*PRM/523	11,15,33,37
-	PRM/710	78,108,109,134,135,186, 278,279,314,315,351
ACCESSORI		
-	930/001	18,19,40,41,108,109,134, 135,188,189,242,243,278, 279,314,315,326,327
-	930/002	18,19,40,41,108,109,134,

Cod. Covind Covind Ref. Covind Teilnummer	Cod. Originale O.E.M. Ref. OE Nummer	Pag.Cat. Page Cat. Seite
-	-	135,188,189,242,243,278, 279,314,315,326,327
-	930/033	18,19,40,41,108,109,134, 135,188,189,242,243,278, 279,314,315,326,327
-	930/100	18,19,40,41,108,109,134, 135,188,189,242,243,278, 279,314,315,326,327
-	930/101	18,19,40,41,108,109,134, 135,188,189,242,243,278, 279,314,315,326,327
-	930/200	18,19,40,41,108,109,134, 135,188,189,242,243,278, 279,314,315,326,327
-	940/110	117,288
-	940/112	319
-	940/113	319
-	940/116	116,287
-	PDS/360	5,42,78,101,127,186, 241,280,304,324,350
-	-	-
-	-	-
-	-	-
-	-	-
-	-	-
-	-	-
-	-	-
-	-	-
-	-	-
-	-	-
-	-	-
-	-	-
-	-	-
-	-	-
-	-	-
-	-	-
-	-	-
-	-	-
-	-	-
-	-	-
-	-	-
-	-	-
-	-	-
-	-	-
-	-	-

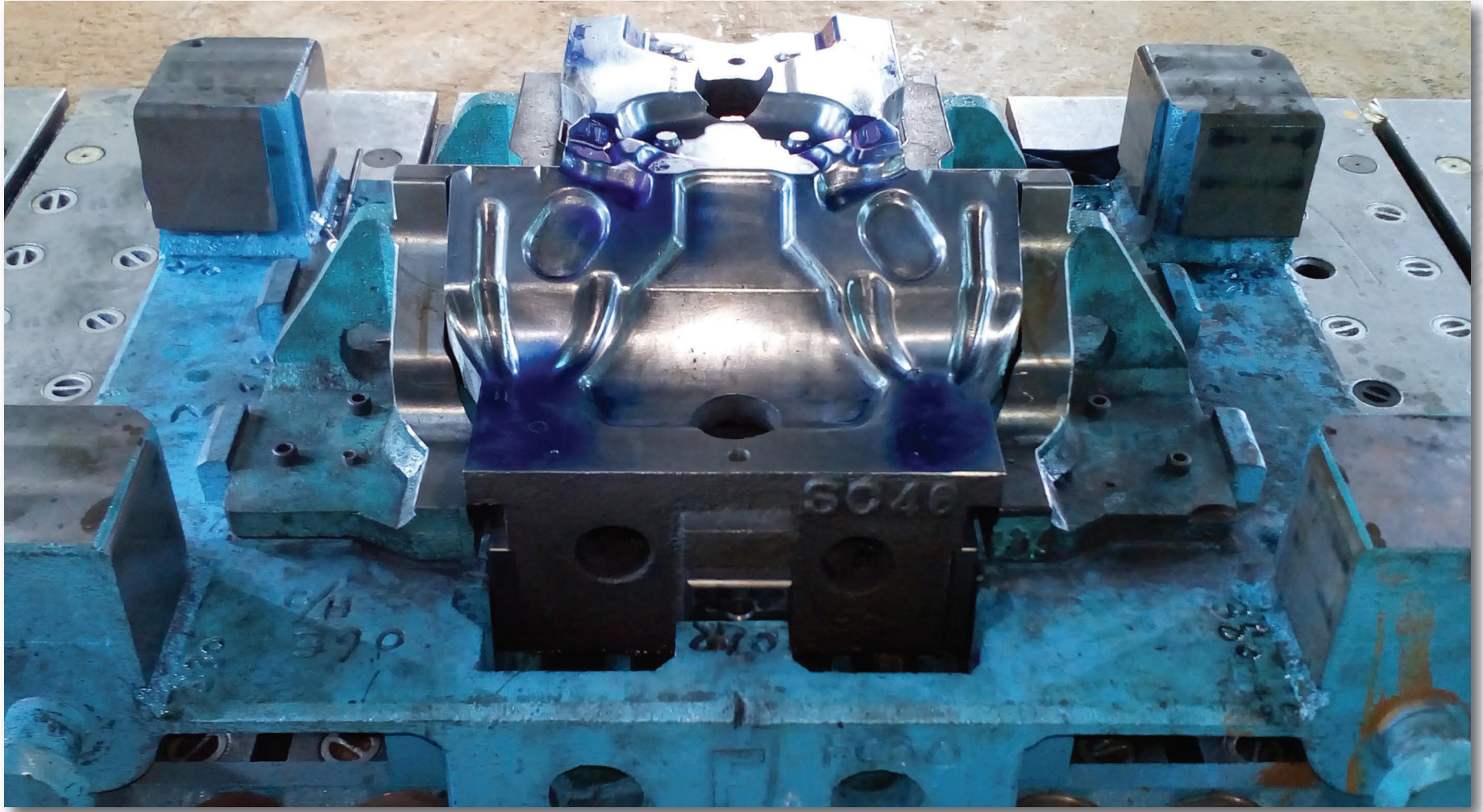

gallery



Cod. Covind Covind Ref. Covind Teilnummer	Cod. Originale O.E.M. Ref. OE Nummer	Pag.Cat. Page Cat. Seite
0FE/400	20937431	2,22
0FE/400	20501225	2,22
0FH/ 4	20398908	301
0FH/ 4	1086534	301
0FH/ 4	1619691	301
0FH/ 5	20398907	301
0FH/ 5	1086533	301
0FH/ 5	1619690	301
0FH/ 50	1619106	290
0FH/ 90	8189329	113,284
0FH/ 90	8144454	113,284
0FH/ 92	20372227	113,284
0FH/ 92	1626680	113,284
0FH/ 93	20372226	113,284
0FH/ 93	1626679	113,284
0FH/ 94	8141290	115,286
0FH/ 95	8141289	115,286
0FH/ 96	8152722	113,284
0FH/ 96	8189337	113,284
0FH/ 96	3981256	113,284
0FH/105	8189295	-
0FH/105	8189130	-
0FH/105	8191316	-
0FH/110	8191220	290
0FH/110	8143393	290
0FH/134	20398386	286
0FH/134	1062548	286
0FH/134	3090971	286
0FH/134	3980870	286
0FH/135	20398385	286
0FH/135	1062547	286
0FH/135	3090972	286
0FH/135	3980869	286
0FH/144	-	289
0FH/145	20360507	289

Cod. Covind Covind Ref. Covind Teilnummer	Cod. Originale O.E.M. Ref. OE Nummer	Pag.Cat. Page Cat. Seite
0FH/145	8144455	289
0FH/146	8144524	289
0FH/147	8144525	289
0FH/148	8144527	289
0FH/149	8144526	289
0FH/150	1063509	115,286
0FH/150	8144482	115,286
0FH/155	3175863	115,286
0FH/155	8189467	115,286
0FH/160	8189093	290
0FH/160	1619149	290
0FH/161	8189092	290
0FH/161	1619148	290
0FH/166	3953182	260,300
0FH/166	1606375	260,300
0FH/190	3175029	99,119,204,258,298
0FH/191	20379593	259,299
0FH/192	1063328	203,259,299
0FH/192	8142044	203,259,299
0FH/193	1063327	203,259,299
0FH/193	8142043	203,259,299
0FH/194	20398467	56,98,118,205,261,301,334
0FH/194	1062566	56,98,118,205,261,301,334
0FH/194	3175919	56,98,118,205,261,301,334
0FH/195	20398466	56,98,118,205,261,301,334
0FH/195	1062565	56,98,118,205,261,301,334
0FH/195	3175918	56,98,118,205,261,301,334
0FH/196	3090484	98,118,205,261,301,334
0FH/197	-	56,98,118,205,261,301,334
0FH/198	-	56,98,118,205,261,301,334
0FH/199	20529765	268,303
0FH/199	3981043	268,303
0FH/200	8144108	302
0FH/200	3175247	302
0FH/200	3981764	302

Cod. Covind Covind Ref. Covind Teilnummer	Cod. Originale O.E.M. Ref. OE Nummer	Pag.Cat. Page Cat. Seite
0FH/200	8189196	302
0FH/200	8189301	302
0FH/201	8144107	302
0FH/201	3175246	302
0FH/201	3981762	302
0FH/201	8189195	302
0FH/201	8189300	302
0FH/204	8141237	302
0FH/204	8122894	302
0FH/205	8141236	302
0FH/205	8122893	302
0FH/210	20379439	213,269,305
0FH/210	8191105	213,269,305
0FH/210	8191315	213,269,305
0FH/212	20379438	305
0FH/212	8191104	305
0FH/212	8191314	305
0FH/215	20379437	305
0FH/215	8191103	305
0FH/215	8191313	305
0FH/240	8141004	303
0FH/241	8141003	303
0FH/242	8141313	304
0FH/243	8141312	304
0FH/320	1623459	304
0FH/321	8156540	304
0FH/400	8189318	291
0FH/400	8140923	291
0FH/506	20854564	121,123,293,295
0FH/506	3092854	121,123,293,295
0FH/507	21203311	121,123,293,295
0FH/508	-	120,292
0FH/509	-	122,294
0FH/510	8156556	128,306
0FH/510	1599297	128,306

Cod. Covind Covind Ref. Covind Teilnummer	Cod. Originale O.E.M. Ref. OE Nummer	Pag.Cat. Page Cat. Seite
OFH/512	3091751	121,293
OFH/513	3091750	123,295
OFH/515	8190106	128,129,306,307
OFH/515	8155808	128,129,306,307
OFH/518	8156551	128,129,306,307
OFH/518	8156552	128,129,306,307
OFH/519	8156554	128,129,306,307
OFH/520	8154385	105,133,239,274,311,348
OFH/520	1077451	105,133,239,274,311,348
OFH/521	20466895	105,133,239,274,311,348
OFH/521	3197851	105,133,239,274,311,348
OFH/522	20466894	105,133,237,273,312,347
OFH/522	3197850	105,133,237,273,312,347
OFH/526	20382890	237,273,312,347
OFH/527	20383038	237,273,312,347
OFH/604	3981668	117,288
OFH/610	3981666	117,288
OFH/610	8191142	117,288
OFH/650	1062190	113,285
OFH/650	22105756	113,285
OFH/670	20896946	110,281,316,324
OFH/670	9520400	110,281,316,324
OFH/675	21281403	39,77,110,134, 187,244,281,316
OFH/675	20703186	39,77,110,134, 187,244,281,316
OFH/675	20926021	39,77,110,134, 187,244,281,316
OFH/675	21075528	39,77,110,134, 187,244,281,316
OFH/675	21075529	39,77,110,134, 187,244,281,316
OFH/675	21075530	39,77,110,134, 187,244,281,316
OFH/675	21106301	39,77,110,134,

Cod. Covind Covind Ref. Covind Teilnummer	Cod. Originale O.E.M. Ref. OE Nummer	Pag.Cat. Page Cat. Seite
		187,244,281,316
OFH/710	3981593	116,287
OFH/720	20360274	285
OFH/721	20360273	285
OFH/800	1619254	289
OFL/400	20937442	3,23
OFL/400	20743944	3,23
OFM/ 50	8191439	114
OFM/110	8191421	114
OFM/134	20398388	115
OFM/134	20398390	115
OFM/134	8191570	115
OFM/135	20398387	115
OFM/135	1062163	115
OFM/135	20398389	115
OFM/145	8191406	114
OFM/160	8191412	114
OFM/161	8191409	114
OFM/170	8140016	7,99,119,204
OFM/174	-	56,99,119,204,260,300,334
OFM/175	-	56,99,119,204,260,300,334
OFM/198	8191781	127,337
OFM/199	8191780	127,337
OFM/206	20530083	126,337
OFM/206	8191779	126,337
OFM/207	20530082	126,337
OFM/207	8191778	126,337
OFM/210	1063726	57,100,126,336
OFM/240	1062134	126
OFM/240	8191594	126
OFM/241	8191593	126
OFM/241	1062133	126
2FH/ 2	20360543	205,261,301
2FH/ 2	3980433	205,261,301
2FH/ 3	20360542	205,261,301

Cod. Covind Covind Ref. Covind Teilnummer	Cod. Originale O.E.M. Ref. OE Nummer	Pag.Cat. Page Cat. Seite
2FH/ 3	3980432	205,261,301
2FH/ 4	21300059	205,261
2FH/ 4	20467038	205,261
2FH/ 5	21299955	205,261
2FH/ 5	20467037	205,261
2FH/ 6	20398136	203,258,298,335
2FH/ 6	20372038	203,258,298,335
2FH/ 6	1623148	203,258,298,335
2FH/ 7	20398135	203,258,298,335
2FH/ 7	20372037	203,258,298,335
2FH/ 7	1623147	203,258,298,335
2FH/ 9	1062636	203,258,298
2FH/ 10	20372039	203,258,298,335
2FH/ 10	1062637	203,258,298,335
2FH/ 50	20379348	197,251,333
2FH/ 80	21828914	81,193,247
2FH/ 80	20398709	81,193,247
2FH/ 80	20429679	81,193,247
2FH/ 80	20711859	81,193,247
2FH/ 84	21829052	81,193,247
2FH/ 84	20398708	81,193,247
2FH/ 84	20429681	81,193,247
2FH/ 84	20711861	81,193,247
2FH/ 85	21829051	81,193,247
2FH/ 85	20398707	81,193,247
2FH/ 85	20429680	81,193,247
2FH/ 85	20711860	81,193,247
2FH/ 86	21430599	84,195,249
2FH/ 86	20456804	84,195,249
2FH/ 87	21430672	84,195,249
2FH/ 87	20456806	84,195,249
2FH/ 88	21430600	84,195,249
2FH/ 88	20456805	84,195,249
2FH/ 89	20529740	83,194,248
2FH/ 89	3175417	83,194,248

Cod. Covind Covind Ref. Covind Teilnummer	Cod. Originale O.E.M. Ref. OE Nummer	Pag.Cat. Page Cat. Seite
2FH/ 90	21359080	82,194,248
2FH/ 90	20425625	82,194,248
2FH/ 92	21359090	82,194,248
2FH/ 92	20425627	82,194,248
2FH/ 93	21359082	82,194,248
2FH/ 93	20425626	82,194,248
2FH/ 94	21359260	87,253
2FH/ 94	20453931	87,253
2FH/ 94	20507021	87,253
2FH/ 95	21359257	87,253
2FH/ 95	20453930	87,253
2FH/ 95	20507020	87,253
2FH/ 96	20529742	83,194,248
2FH/ 96	3175419	83,194,248
2FH/ 97	20529741	83,194,248
2FH/ 97	3175418	83,194,248
2FH/ 98	20917958	87,253
2FH/ 98	20453628	87,253
2FH/ 98	20534601	87,253
2FH/ 98	20827044	87,253
2FH/ 99	20917957	87,253
2FH/ 99	20453627	87,253
2FH/ 99	20534600	87,253
2FH/ 99	20827042	87,253
2FH/100	21484901	193,247
2FH/100	20456550	193,247
2FH/100	20467442	193,247
2FH/110	-	85,197,251,333
2FH/110	3175367	85,197,251,333
2FH/110	20530146	85,197,251,333
2FH/110	3175366	85,197,251,333
2FH/111	-	85,197,251,333
2FH/111	20383543	85,197,251,333
2FH/111	20529738	85,197,251,333
2FH/111	3175366	85,197,251,333

Cod. Covind Covind Ref. Covind Teilnummer	Cod. Originale O.E.M. Ref. OE Nummer	Pag.Cat. Page Cat. Seite
2FH/115	20467053	251
2FH/132	20452848	86,252
2FH/133	20452847	86,252
2FH/134	21469924	86,252
2FH/134	20452887	86,252
2FH/135	21469918	86,252
2FH/135	20452886	86,252
2FH/136	21469979	87,253
2FH/136	20425419	87,253
2FH/136	20826231	87,253
2FH/137	21430598	87,253
2FH/137	20425418	87,253
2FH/137	20826227	87,253
2FH/142	20467143	-
2FH/143	20467142	-
2FH/145	20360266	250
2FH/145	21058445	250
2FH/148	20545095	256
2FH/148	20528507	256
2FH/149	20545094	256
2FH/149	20528503	256
2FH/150	21430596	86,252
2FH/150	20453716	86,252
2FH/150	20516776	86,252
2FH/150	21358670	86,252
2FH/152	20409818	89,256
2FH/153	20456963	89,256
2FH/154	20529706	90,255
2FH/154	21023797	90,255
2FH/154	3175546	90,255
2FH/155	20529705	90,255
2FH/155	21023794	90,255
2FH/155	3175545	90,255
2FH/156	20529708	90,255
2FH/156	21023802	90,255

Cod. Covind Covind Ref. Covind Teilnummer	Cod. Originale O.E.M. Ref. OE Nummer	Pag.Cat. Page Cat. Seite
2FH/156	3175548	90,255
2FH/157	20529707	90,255
2FH/157	21023801	90,255
2FH/157	3175547	90,255
2FH/160	20379176	196,250
2FH/161	20379175	196,250
2FH/162	20529672	89,196,250,333
2FH/162	20379358	89,196,250,333
2FH/163	20529668	89,196,250,333
2FH/163	20379357	89,196,250,333
2FH/180	21505894	203,259,299,335
2FH/180	20588326	203,259,299,335
2FH/180	21261275	203,259,299,335
2FH/181	21505893	203,259,299,335
2FH/181	20588325	203,259,299,335
2FH/181	21261274	203,259,299,335
2FH/190	20570722	99,203,259,299,335
2FH/191	20570721	99,203,259,299,335
2FH/200	3175928	212,268
2FH/201	3175927	212,268
2FH/204	20529684	212,268
2FH/204	3175934	212,268
2FH/205	20529682	212,268
2FH/205	3175933	212,268
2FH/206	21302470	212,268
2FH/206	3175930	212,268
2FH/207	21302461	212,268
2FH/207	3175929	212,268
2FH/208	20360789	57,100,213,269,336
2FH/209	20360788	57,100,213,269,336
2FH/236	20453677	81,193,247
2FH/236	20453679	81,193,247
2FH/237	20453676	81,193,247
2FH/237	20453678	81,193,247
2FH/240	20529640	100,212,268,336

Cod. Covind Covind Ref. Covind Teilnummer	Cod. Originale O.E.M. Ref. OE Nummer	Pag.Cat. Page Cat. Seite
2FH/240	3175407	100,212,268,336
2FH/241	20529638	100,212,268,336
2FH/241	3175406	100,212,268,336
2FH/316	20372065	269
2FH/317	20372064	269
2FH/325	20453900	269,337
2FH/400	20456709	91,257
2FH/410	20527443	91,257
2FH/480	20467422	91,257
2FH/480	20467412	91,257
2FH/480	20467414	91,257
2FH/480	20467424	91,257
2FH/500	-	92,262
2FH/501	-	94,264
2FH/502	20746401	93,95,263,265
2FH/502	20360810	93,95,263,265
2FH/503	21320404	53,55,93,95,207,209,263,265
2FH/503	20589788	53,55,93,95,207,209,263,265
2FH/504	21320300	93,95,263,265
2FH/504	20455995	93,95,263,265
2FH/504	20567685	93,95,263,265
2FH/505	20392544	102,103,105,130,131,133, 234,235,237,270,271,273, 275,308,309,313,344,345, 346,347
2FH/506	20854644	96,124,266,296
2FH/506	1096643	96,124,266,296
2FH/508	20360811	93,95,263,265
2FH/510	1079981	104,132,238,272,310,349
2FH/513	20583434	104,132,238,272,310,349
2FH/513	20498620	104,132,238,272,310,349
2FH/514	20583440	104,132,238,272,310,349
2FH/514	3987253	104,132,238,272,310,349
2FH/515	20936759	102,103,130,131,234,235, 270,271,308,309,344,345

Cod. Covind Covind Ref. Covind Teilnummer	Cod. Originale O.E.M. Ref. OE Nummer	Pag.Cat. Page Cat. Seite
2FH/515	1079965	102,103,130,131,234,235, 270,271,308,309,344,345
2FH/515	20722652	102,103,130,131,234,235, 270,271,308,309,344,345
2FH/515	3171391	102,103,130,131,234,235, 270,271,308,309,344,345
2FH/515	20514389	102,103,130,131,234,235, 270,271,308,309,344,345
2FH/515	20723526	102,103,130,131,234,235, 270,271,308,309,344,345
2FH/517	3987252	102,104,130,132,234,238, 270,272,308,310,344,349
2FH/518	20392599	102,103,130,131,234,235, 270,271,275,308,309,313, 344,345,346
2FH/520	20936769	102,103,130,131,234,235, 270,271,308,309,344,345
2FH/520	20722654	102,103,130,131,234,235, 270,271,308,309,344,345
2FH/522	20375540	106,276
2FH/526	21213202	74,182,239
2FH/527	20375489	106,276
2FH/528	21090272	74,182,239
2FH/602	21001649	88,254
2FH/602	20763003	88,254
2FH/602	20861574	88,254
2FH/603	21001645	88,254
2FH/603	20763004	88,254
2FH/603	20861573	88,254
2FH/604	21001668	88,254
2FH/604	20360899	88,254
2FH/604	20713721	88,254
2FH/604	20762993	88,254
2FH/604	20861584	88,254
2FH/605	21001663	88,254

Cod. Covind Covind Ref. Covind Teilnummer	Cod. Originale O.E.M. Ref. OE Nummer	Pag.Cat. Page Cat. Seite
2FH/605	20360898	88,254
2FH/605	20713720	88,254
2FH/605	20762994	88,254
2FH/605	20861583	88,254
2FH/606	20826213	87,253
2FH/606	20409875	87,253
2FH/607	20826211	87,253
2FH/607	20409874	87,253
2FH/610	20789440	78,101,186,241,280,350
2FH/619	20507252	39,110,281,316
2FH/619	3127594	39,110,281,316
2FH/620	1676400	-
2FM/ 2	20360850	98,118,334
2FM/ 3	20360849	98,118,334
2FM/ 50	20379349	85
2FM/145	3175376	85
2FM/160	20379172	89,333
2FM/161	20379171	89,333
3FH/ 85	21425186	90,198,255
3FH/ 85	20453690	90,198,255
3FH/ 94	21451002	200
3FH/ 94	82056991	200
3FH/ 95	21451000	200
3FH/ 95	82052484	200
3FH/ 96	82066335	202
3FH/ 97	82066238	202
3FH/ 98	82209849	200
3FH/ 98	(82056986+ 169898-02)	200
3FH/ 98	82367957	200
3FH/ 99	82367098	200
3FH/ 99	(82053690+ 169898-01)	200
3FH/ 99	82209788	200
3FH/134	21478755	200

Cod. Covind Covind Ref. Covind Teilnummer	Cod. Originale O.E.M. Ref. OE Nummer	Pag.Cat. Page Cat. Seite
3FH/134	82076266	200
3FH/135	21478759	200
3FH/135	82076158	200
3FH/136	21078545	202
3FH/137	21078543	202
3FH/140	21190825	196
3FH/140	82056727	196
3FH/142	82215401	196,250
3FH/143	82215391	196,250
3FH/148	82060445	199
3FH/149	82060441	199
3FH/150	21445302	198
3FH/150	82056840	198
3FH/150	82065607	198
3FH/151	21445754	198
3FH/151	82090257	198
3FH/152	82072463	199
3FH/154	82063513	199
3FH/156	82063911	198
3FH/157	82062209	198
3FH/323	82637695	58,213
3FH/323	84007259	58,213
3FH/502	-	92,262
3FH/503	-	94,264
3FH/504	22286155	52,206
3FH/505	22286149	54,208
3FH/506	-	52,206
3FH/507	-	54,208
3FH/508	20841436	53,55,207,209
3FH/509	21320365	53,55,207,209
3FH/509	21070768	53,55,207,209
3FH/509	20589798	53,55,207,209
3FH/510	21094457	60,62,64,66,68,70,72,164, 166,168,170,172,174,176, 178,180,214,216,218,220,

Cod. Covind Covind Ref. Covind Teilnummer	Cod. Originale O.E.M. Ref. OE Nummer	Pag.Cat. Page Cat. Seite
		222,224,226,228,230,232, 338,340,342
3FH/511	21169974	53,55,207,209
3FH/511	20746402	53,55,207,209
3FH/514	20716956	97,210
3FH/515	21094391	60,61,62,63,66,67,70,71,74, 164,165,166,167,170,171, 174,175,178,179,214,215, 216,217,220,221,222,223, 226,227,230,231,236,338, 339,340,341,342,343,346
3FH/515	22087684	60,61,62,63,66,67,70,71,74, 164,165,166,167,170,171, 174,175,178,179,214,215, 216,217,220,221,222,223, 226,227,230,231,236,338, 339,340,341,342,343,346
3FH/517	21094406	59,183,240
3FH/520	21094388	60,61,62,63,64,65,170,171, 172,173,220,221,222,223, 224,225,342,343
3FH/522	21094392	64,65,68,69,72,73,74,168, 169,172,173,176,177,180, 181,218,219,224,225,228, 229,232,233,236
3FH/522	21305345	64,65,68,69,72,73,74,168, 169,172,173,176,177,180, 181,218,219,224,225,228, 229,232,233,236
3FH/522	22087701	64,65,68,69,72,73,74,168, 169,172,173,176,177,180, 181,218,219,224,225,228, 229,232,233,236
3FH/523	21094393	64,65,68,69,72,73,74,168, 169,172,173,176,177,180,

Cod. Covind Covind Ref. Covind Teilnummer	Cod. Originale O.E.M. Ref. OE Nummer	Pag.Cat. Page Cat. Seite
		181,218,219,224,225,228, 229,232,233,236
3FH/523	21305346	64,65,68,69,72,73,74,168, 169,172,173,176,177,180, 181,218,219,224,225,228, 229,232,233,236
3FH/523	22087703	64,65,68,69,72,73,74,168, 169,172,173,176,177,180, 181,218,219,224,225,228, 229,232,233,236
3FH/524	21094447	60,61,164,165,214,215, 220,338,339
3FH/525	21094394	62,63,64,65,66,67,68,69,70, 71,72,73,74,166,167,168, 169,170,171,172,173,174, 175,176,177,178,179,180, 181,216,217,218,219,222, 223,224,225,226,227,228, 229,230,231,232,233,236, 340,341,342,343,346
3FH/525	21094400	62,63,64,65,66,67,68,69,70, 71,72,73,74,166,167,168, 169,170,171,172,173,174, 175,176,177,178,179,180, 181,216,217,218,219,222, 223,224,225,226,227,228, 229,230,231,232,233,236, 340,341,342,343,346
3FH/526	21094456	61,74,165,215,236,339
3FH/526	21094454	61,74,165,215,236,339
3FH/527	22192010	74,236
3FH/527	21094411	74,236
3FH/528	22192007	74,236
3FH/528	21094410	74,236
3FH/530	21094383	66,67,68,69,174,175,176,

Cod. Covind Covind Ref. Covind Teilnummer	Cod. Originale O.E.M. Ref. OE Nummer	Pag.Cat. Page Cat. Seite
		177,226,227,228,229
3FH/530	21094387	66,67,68,69,174,175,176, 177,226,227,228,229
3FH/532	22192015	74,236,346
3FH/532	21094413	74,236,346
3FH/535	21094389	70,71,72,73,178,179,180, 181,230,231,232,233
3FH/540	21094390	164,165,166,167,168,169, 214,215,216,217,218,219, 338,339,340,341
3FH/540	21094386	164,165,166,167,168,169, 214,215,216,217,218,219, 338,339,340,341
3FH/602	82304585	200
3FH/602	21123489	200
3FH/603	82304599	200
3FH/603	21123523	200
3FH/608	21478751	202,331
3FH/608	82114502	202,331
3FH/609	21448885	202,331
3FH/609	82114504	202,331
3FH/610	82114500	202,331
3FH/611	84139937	202,331
3FH/611	82114506	202,331
3FH/611	82355678	202,331
3FH/619	20541447	-
3FH/700	21297909	201
3FH/700	21035690	201
3FH/701	21297911	201
3FH/701	21035692	201
3FH/702	21297904	201
3FH/702	21035700	201
3FH/703	21297905	201
3FH/703	21035701	201
3FH/704	21297917	201

Cod. Covind Covind Ref. Covind Teilnummer	Cod. Originale O.E.M. Ref. OE Nummer	Pag.Cat. Page Cat. Seite
3FH/705	21297918	201
3FH/815	-	60,61,164,165,214,215, 338,339
3FX/ 42	82266040	332
3FX/ 43	82266039	332
3FX/ 98	82424434	332
3FX/ 99	82423778	332
3FX/130	21404043	331
3FX/131	21404042	331
3FX/132	82266404	331
3FX/134	82266416	332
3FX/135	82266415	332
4FH/ 4	21642399	162
4FH/ 4	82178247	162
4FH/ 5	21642377	162
4FH/ 5	82107271	162
4FH/ 8	23311948	159
4FH/ 8	82319253	159
4FH/ 9	23311945	159
4FH/ 9	82319029	159
4FH/ 40	84013223	151
4FH/ 40	82155980	151
4FH/ 41	84013224	151
4FH/ 41	82155978	151
4FH/ 42	82213089	157
4FH/ 43	82232959	157
4FH/ 66	82141524	163
4FH/ 67	82110404	163
4FH/ 80	21838943	44,144
4FH/ 84	21838945	44,144
4FH/ 85	21838944	44,144
4FH/ 87	2143787	45,145
4FH/ 87	82090733	45,145
4FH/ 87	84172098	45,145
4FH/ 88	21413786	45,145

Cod. Covind Covind Ref. Covind Teilnummer	Cod. Originale O.E.M. Ref. OE Nummer	Pag.Cat. Page Cat. Seite
4FH/ 88	82090735	45,145
4FH/ 89	21413789	45,145
4FH/ 89	82090731	45,145
4FH/ 90	21316576	45,145
4FH/ 92	21316577	45,145
4FH/ 93	21316575	45,145
4FH/ 95	21495267	146
4FH/ 96	21495268	146
4FH/ 97	21495266	146
4FH/ 98	82943981	44,144
4FH/ 99	82928883	44,144
4FH/102	82101912	146
4FH/104	82101914	146
4FH/105	82101910	146
4FH/106	82835601	147
4FH/107	82835554	147
4FH/108	84055530	147
4FH/108	82871739	147
4FH/108	82217687	147
4FH/109	82846116	157
4FH/110	82846118	157
4FH/121	23462387	157
4FH/121	82858516	157
4FH/122	23462398	157
4FH/122	82858486	157
4FH/124	82453926	48,154
4FH/125	82446592	48,154
4FH/126	21413774	48,154
4FH/127	21413734	48,154
4FH/128	84139933	151
4FH/128	82462703	151
4FH/128	84034942	151
4FH/129	84139886	151
4FH/129	82462702	151
4FH/129	84034945	151

Cod. Covind Covind Ref. Covind Teilnummer	Cod. Originale O.E.M. Ref. OE Nummer	Pag.Cat. Page Cat. Seite
4FH/131	84058023	48,154
4FH/131	82285617	48,154
4FH/132	84046776	48,154
4FH/134	21874457	151
4FH/135	21874450	151
4FH/136	23386781	48,154
4FH/136	82151205	48,154
4FH/137	82884080	151
4FH/138	23386782	48,154
4FH/138	82151157	48,154
4FH/139	82884084	151
4FH/140	82360122	157
4FH/142	82320177	156
4FH/143	82320176	156
4FH/145	84033228	157
4FH/145	82219161	157
4FH/146	84228541	156
4FH/147	84228539	156
4FH/148	82187116	148
4FH/149	82186579	148
4FH/150	82491903	148
4FH/150	84049560	148
4FH/151	82180491	149
4FH/152	82220161	149
4FH/152	82208512	149
4FH/153	82258426	148
4FH/154	82177794	149
4FH/155	82220206	149
4FH/155	82208510	149
4FH/156	82255346	148
4FH/156	82208510	148
4FH/157	82857758	156
4FH/158	82857748	156
4FH/202	84096589	162
4FH/202	82328081	162

Cod. Covind Covind Ref. Covind Teilnummer	Cod. Originale O.E.M. Ref. OE Nummer	Pag.Cat. Page Cat. Seite
4FH/203	84096588	162
4FH/203	82328082	162
4FH/204	82819477	161
4FH/205	82819482	161
4FH/208	82859306	161
4FH/209	82171603	161
4FH/240	82142373	161
4FH/241	82141971	161
4FH/242	21392187	161
4FH/242	21344649	161
4FH/243	21392183	161
4FH/243	21344647	161
4FH/244	82141521	161
4FH/245	82136982	161
4FH/250	84233571	162
4FH/250	21413763	162
4FH/250	82180201	162
4FH/251	21940892	162
4FH/255	21413732	162
4FH/255	82181355	162
4FH/324	84106936	58,163
4FH/324	82868625	58,163
4FH/324	84160721	58,163
4FH/324	84160723	58,163
4FH/400	82166469	158
4FH/410	84014254	158
4FH/410	82131055	158
4FH/426	21346522	154
4FH/427	21346521	154
4FH/506	84167321	160
4FH/506	84004929	160
4FH/506	82110547	160
4FH/555	82298657	150
4FH/556	82298483	150
4FH/558	84575369	150

Cod. Covind Covind Ref. Covind Teilnummer	Cod. Originale O.E.M. Ref. OE Nummer	Pag.Cat. Page Cat. Seite
4FH/558	82298407	150
4FH/600	22239220	49,152
4FH/600	21221133	49,152
4FH/601	22239221	49,152
4FH/601	21221134	49,152
4FH/602	21608666	152
4FH/603	21608667	152
4FH/604	22239225	50,153
4FH/604	21608661	50,153
4FH/605	22239226	50,153
4FH/605	21608663	50,153
4FH/606	22239217	49,153
4FH/606	21221129	49,153
4FH/607	22239219	49,153
4FH/607	21221130	49,153
4FH/608	22239248	49,153
4FH/608	21221145	49,153
4FH/609	22239250	49,153
4FH/609	21221146	49,153
4FH/700	22332596	155
4FH/700	21221155	155
4FH/701	22332597	155
4FH/701	21221156	155
4FH/702	22332594	50,155
4FH/702	21221153	50,155
4FH/703	22332595	50,155
4FH/703	21221154	50,155
4FH/704	22332598	155
4FH/704	21221157	155
4FH/705	22332600	155
4FH/705	21221158	155
4FH/706	22332603	155
4FH/706	21221159	155
4FH/707	22332604	155
4FH/707	21221160	155

Cod. Covind Covind Ref. Covind Teilnummer	Cod. Originale O.E.M. Ref. OE Nummer	Pag.Cat. Page Cat. Seite
4FH/708	22332592	50,155
4FH/708	21221151	50,155
4FH/709	22332593	50,155
4FH/709	21221152	50,155
4FM/108	82439937	51
4FM/109	82448104	51
4FM/110	82448110	51
4FM/111	84151824	51
4FM/112	84151777	51
4FM/120	84162402	47
4FM/121	84167413	47
4FM/124	82430057	51
4FM/125	82430056	51
4FM/128	82426187	48
4FM/129	82426186	48
4FM/132	84028392	48
4FM/133	84027783	48
4FM/146	82410206	47
4FM/147	82409793	47
4FM/148	82454671	46
4FM/149	82444204	46
4FM/151	82454672	46
4FM/153	82455156	46
4FM/156	84104144	47,150
4FM/157	84104142	47,150
4FM/157	78629519	47,150
4FM/204	82610343	58
4FM/204	82653837	58
4FM/204	82610859	58
4FM/205	82610342	58
4FM/205	82653839	58
4FM/205	82610858	58
4FM/240	21520119	57
4FM/241	21520015	57
4HR/ 80	22247766	138,144

Cod. Covind Covind Ref. Covind Teilnummer	Cod. Originale O.E.M. Ref. OE Nummer	Pag.Cat. Page Cat. Seite
4HR/ 84	82694422	138
4HR/ 85	82694421	138
4HR/ 87	84195623	139
4HR/ 88	22766200	139
4HR/ 88	22766195	139
4HR/ 89	22766199	139
4HR/ 89	22766194	139
4HR/ 90	22249883	139
4HR/ 92	84205718	139
4HR/ 95	22245579	140
4HR/ 96	22671460	140
4HR/ 97	22671508	140
4HR/ 98	84234669	141
4HR/ 99	84233646	141
4HR/102	84038586	140
4HR/102	22773913	140
4HR/104	82674762	140
4HR/105	82674760	140
4HR/134	84448800	141
4HR/134	23526802	141
4HR/135	84448796	141
4HR/135	23526465	141
4HR/434	84448715	141
4HR/435	84449120	141
V12/ 2	1698651-5	322
V12/ 3	1698650-7	322
V12/ 4	1571118	322
V12/ 5	1571117	322
V12/ 6	1697968-4	322
V12/ 7	1697967-6	322
V12/ 74	1612622-9	322
V12/ 75	1612621-1	322
V12/ 82	1614461-0	322
V12/ 83	1614460-2	322
V12/ 84	1614457-8	322

Cod. Covind Covind Ref. Covind Teilnummer	Cod. Originale O.E.M. Ref. OE Nummer	Pag.Cat. Page Cat. Seite
V12/ 85	1614456-0	322
V12/ 86	1614459-4	322
V12/ 87	1614458-6	322
V12/ 90	8158216	318
V12/ 90	1080926	318
V12/ 90	8150689	318
V12/ 98	1089123-2	319
V12/ 98	1621904	319
V12/ 99	1089122-4	319
V12/ 99	1621903	319
V12/100	1611178-3	319
V12/102	1614429-7	320
V12/103	1614428-9	320
V12/104	1696262-3	320
V12/105	1588723-5	320
V12/108	1517957-5	318
V12/110	1697976-7	320
V12/111	1621183	319
V12/112	1621182	319
V12/113	1508953	323
V12/134	1698147-4	319
V12/134	1621185	319
V12/135	1698146-6	319
V12/135	1621184	319
V12/155	1083666-6	318
V12/155	1621376	318
V12/156	1698145-8	320
V12/156	1521324	320
V12/156	1621324	320
V12/157	1698144-1	320
V12/157	1621323	320
V12/157	1621325	320
V12/160	1621181-5	318
V12/162	1570898	323
V12/163	1570897	323

Cod. Covind Covind Ref. Covind Teilnummer	Cod. Originale O.E.M. Ref. OE Nummer	Pag.Cat. Page Cat. Seite
V12/168	1607898	318
V12/169	1612331	318
V12/171	680663	323
V12/172	680662	323
V12/173	677950	323
V12/174	1082466	323
V12/174	1508722	323
V12/175	1082467	323
V12/179	1570896	323
V12/180	1570895	323
V12/200	1623888-3	324
V12/210	1509924-5	322
V12/211	1509922-9	322
V12/212	1509511-0	324
V12/214	1509510-2	324
V12/215	1588741-7	324
V12/216	1588740-9	324
V12/230	1509945-0	322
V12/230	1089967	322
V12/231	1578428-3	322
V12/242	1509846-0	322
V12/243	1586124-4	325
V12/243	1589309	325
V12/244	1586120-6	325
V12/244	158612-6	325
V12/246	1614490-9	325
V12/248	1594077-8	321
V12/250	1509799-1	321
V12/251	1509801-5	321
V12/252	1509805-6	321
V12/257	1593174	321
V12/260	1591558	321
V12/270	1509937	321
V12/271	1607178	321
V12/316	1570986-8	325

Cod. Covind Covind Ref. Covind Teilnummer	Cod. Originale O.E.M. Ref. OE Nummer	Pag.Cat. Page Cat. Seite
V12/317	1614589-8	325
V12/340	1664215	321
V12/340	1660358	321
V12/343	1661382	321
V12/347	1665132	321
V12/370	1607094-8	320
V12/375	1592458	320
V12/426	1610788	320
V12/427	1610787	320
V12/800	1591146	318
DAF		
LF0/ 2	85112767	6,27
LF0/ 2	20832787	6,27
LF0/ 3	85112766	6,27
LF0/ 3	20832788	6,27
*LF0/500	21326527	8,30
*LF0/500	20743983	8,30
*LF0/501	20707881	10,32
*LF0/502	21475603	12,34
*LF0/502	20708303	12,34
*LF0/503	20707874	14,36
LF0/504	20862815	9,13,31,35
*LF0/505	20862810	11,15,33,37
LF0/506	20862779	9,11,13,15,31,33,35,37
LF0/507	20862800	9,11,13,15,31,33,35,37
LF0/508	20903732	13,35
*LF0/509	20903723	15,37
LF0/510	-	8,12,30,34
*LF0/511	-	10,14,32,36
LF0/512	-	8,12,30,34
*LF0/513	-	10,14,32,36
XFO/670	-	20,39,77,110,187, 244,281,316,324
MERCEDES		
943/670	20392752	110,187,244,281,316,324

Cod. Covind Covind Ref. Covind Teilnummer	Cod. Originale O.E.M. Ref. OE Nummer	Pag.Cat. Page Cat. Seite
943/670	1189577	110,187,244,281,316,324
RENAULT		
385/ 6	20555723	6,27
385/ 7	20555722	6,27
385/164	84561621	7,28
385/164	82497194	7,28
385/164	20557554	7,28
385/165	84561609	7,28
385/165	82497193	7,28
385/165	20557552	7,28
385/166	82497192	7,28
385/167	82497191	7,28
385/174	22189861	7,28
385/174	84561621	7,28
385/174	82497194	7,28
385/174	20557554	7,28
385/175	22189860	7,28
385/175	84561609	7,28
385/175	82497193	7,28
385/175	20557552	7,28
385/194	24426875	6,27
385/195	24426873	6,27
385/210	5010225181	25
385/212	20538011	4,26
385/213	20538012	4,26
385/215	5010225398	4,25
385/215	5010544527	4,25
385/216	20538248	26
385/217	20538247	26
385/480	20819179	3,23
385/494	21011688	42
385/494	20843281	42
385/495	21011689	42
385/495	20843284	42
MDL/240	20538003	4



gallery





applicabile a | suitable to | verwendbar für

1

OFL
FL 2006 (2006→2012)

applicabile a | suitable to | verwendbar für:

FL 2006



0FE/400

20937431
20501225

materiale | material | material PMMA - Acrylglas

peso | weight | Gewicht 5,120 Kg

applicabilità | suitable to | für VOLVO FE. FE 2006
VOLVO FL. FL 2006
VOLVO VM.

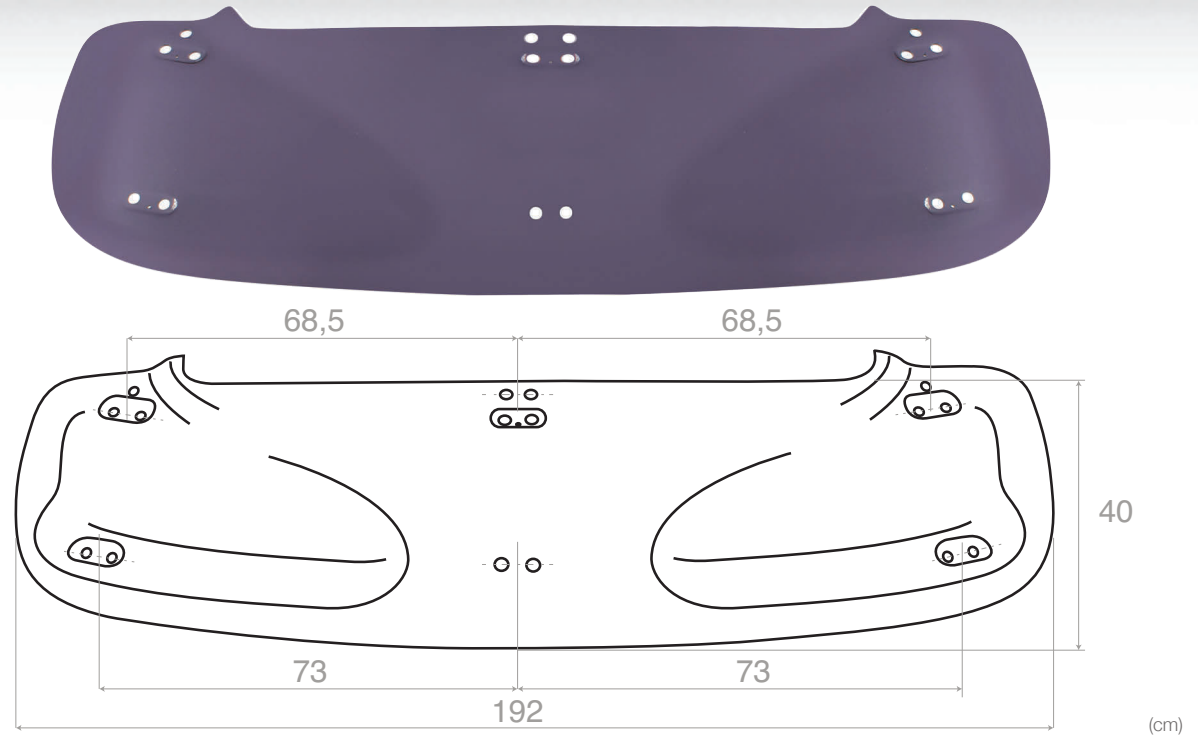

extra



COVIND

0FL/400 20937442
20743944

materiale | material | material PMMA - Acrylglas

peso | weight | Gewicht 5,315 Kg

applicabilità | suitable to | für VOLVO FE. FE 2006
VOLVO FL. FL 2006
VOLVO VM.

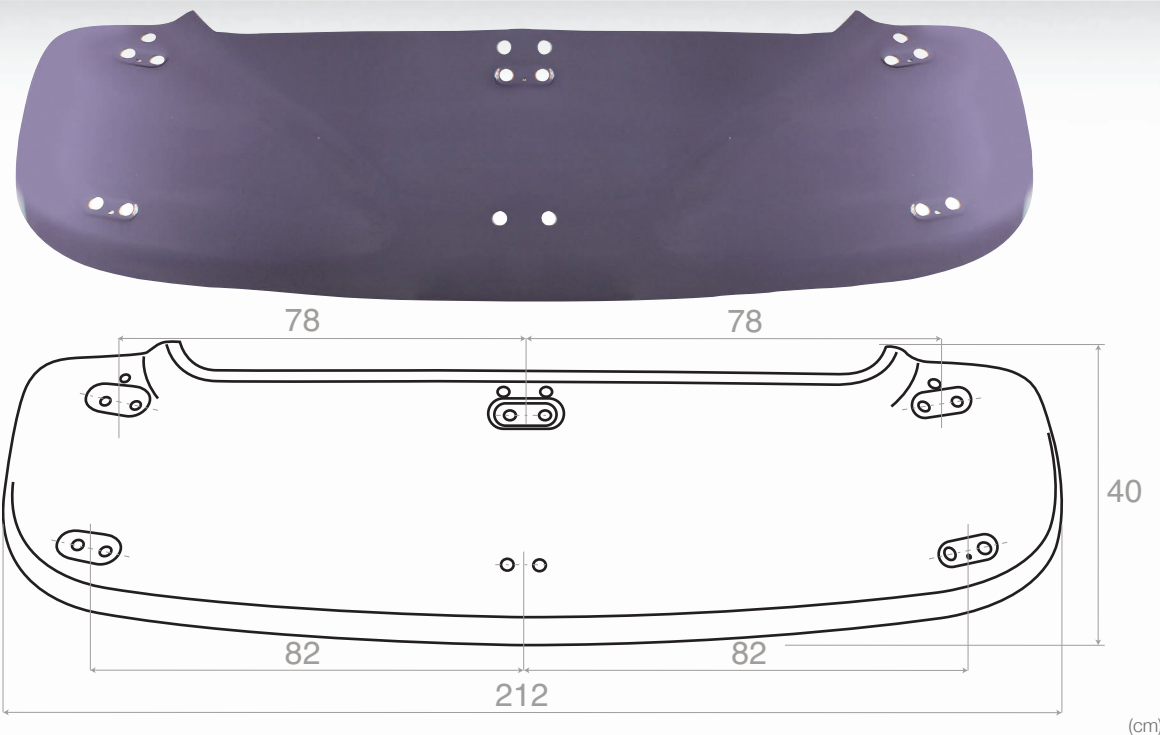

extra



385/480 20819179

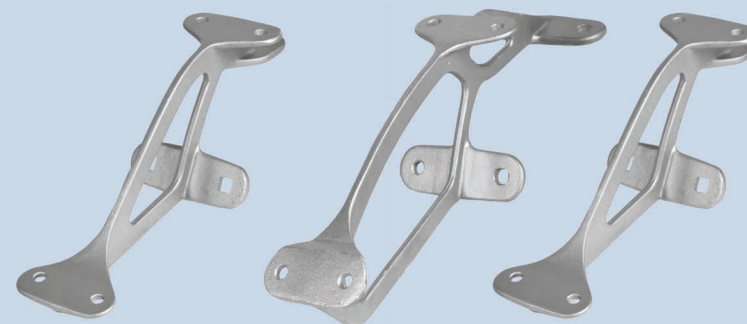

applicabile a | suitable to | verwendbar für:

FL 2006

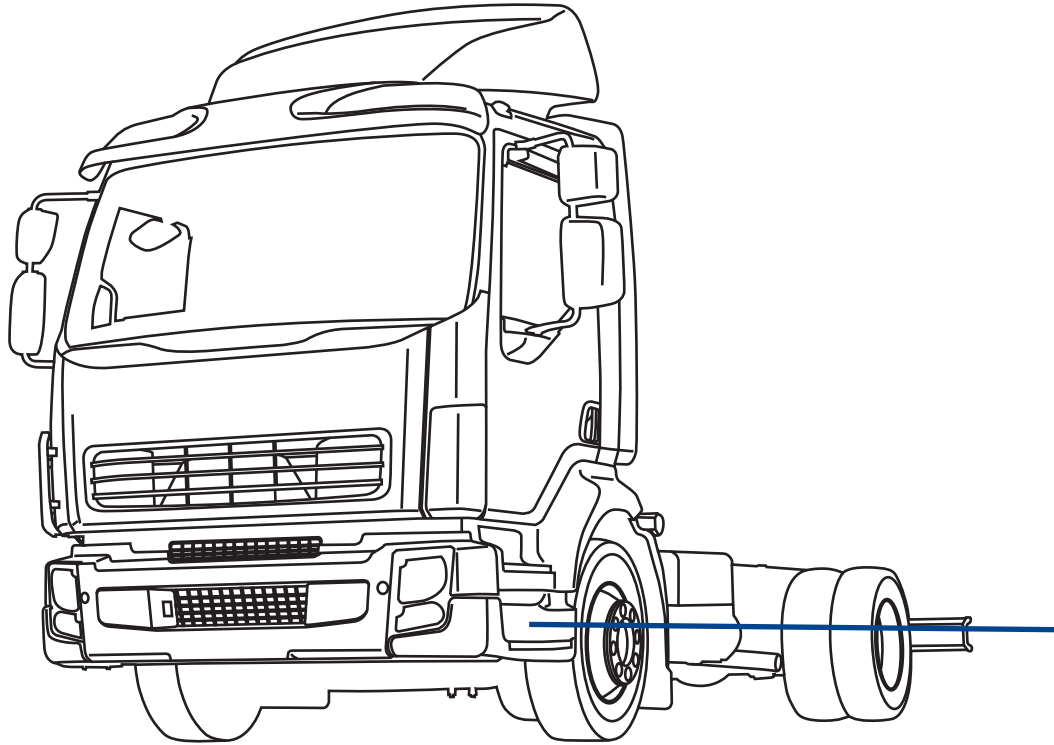

MDL/240 d-rh-rechts
MDL/241 s-lh-links

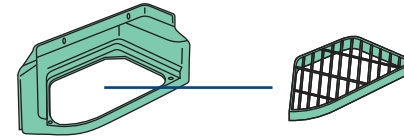

385/215
d|s-rh|lh-rechts|links
alluminio
aluminium
Aluminium

385/212 d-rh-rechts
385/213 s-lh-links
polipropilene
polypropylene
Polypropylen



MDL/240
O.E.M. 20538003
MDL/241
O.E.M. 20538006



385/212
O.E.M. 20538011
385/213
O.E.M. 20538012



385/215
O.E.M. -

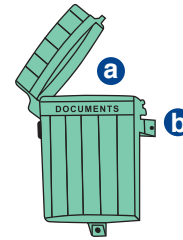
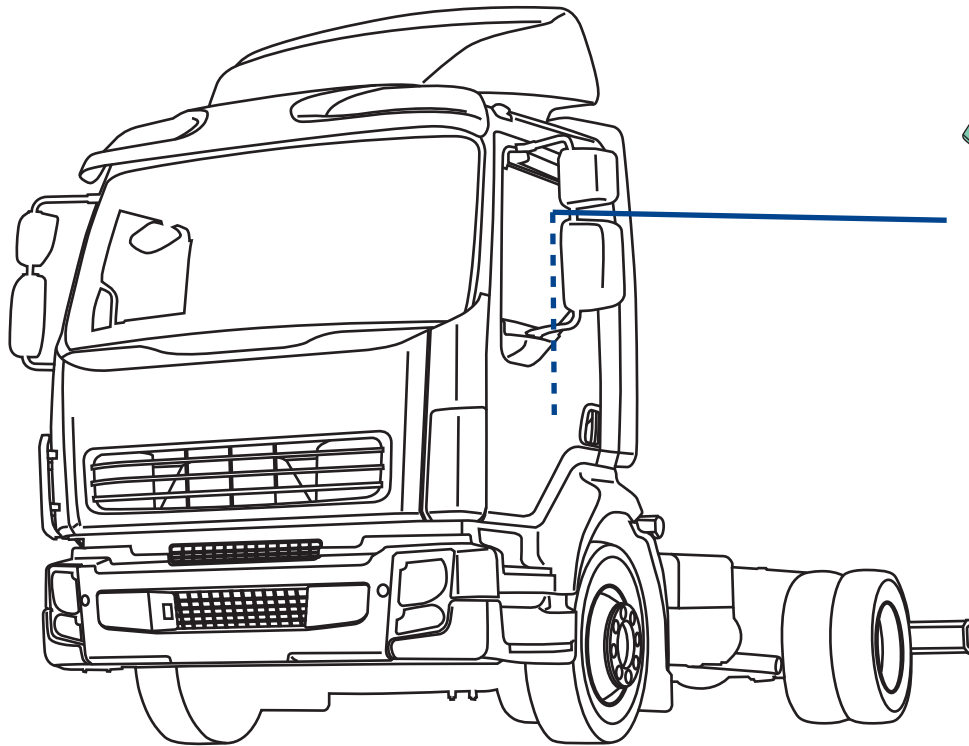

PDS/360

PDS/360

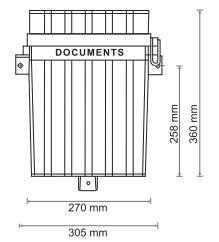

PDS/360
O.E.M. -

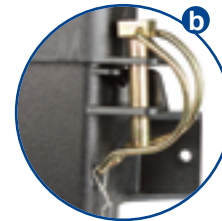

FL 2006

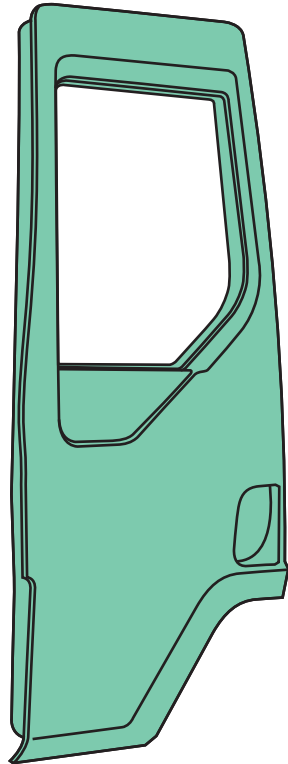

LF0/ 2 d-rh-rechts
LF0/ 3 s-lh-links
senza cerniere
without hinges
ohne Türscharniere

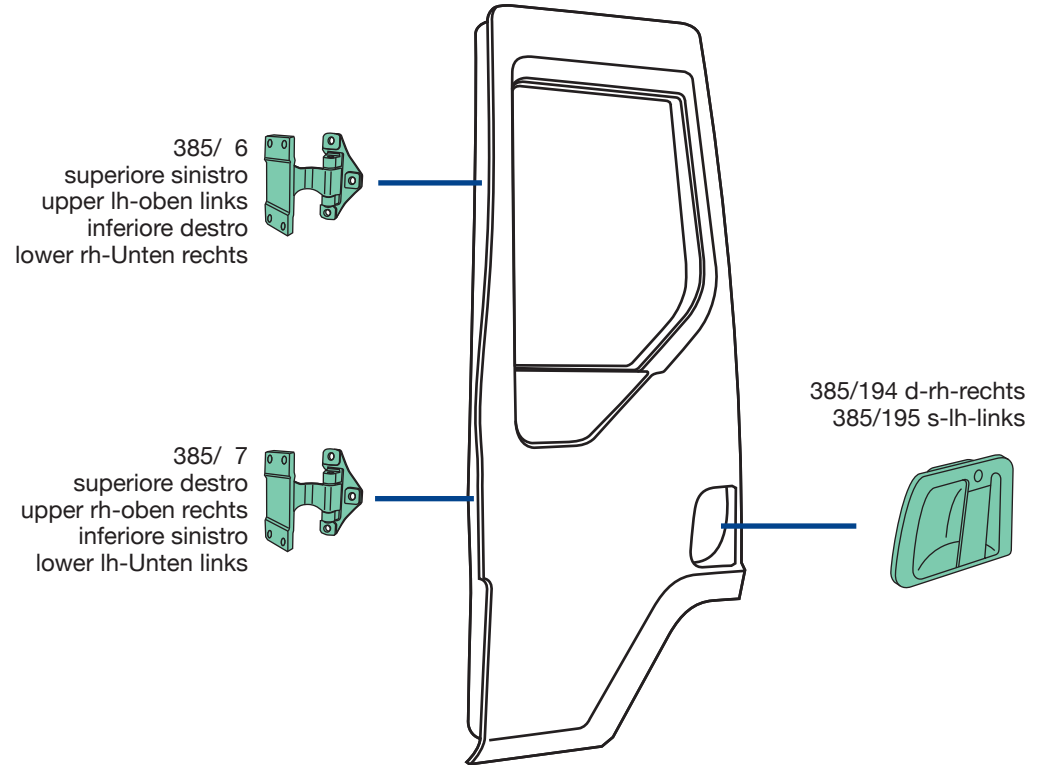

LF0/ 2
O.E.M. 85112767
LF0/ 3
O.E.M. 85112766



385/ 6
O.E.M. 20555723



385/ 7
O.E.M. 20555722



385/194
O.E.M. 24426875
385/195
O.E.M. 24426873

385/166 d-rh-rechts
385/167 s-lh-links
manuale-manual-manuell

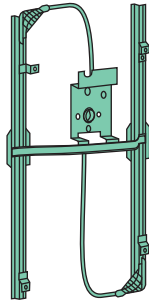

385/164 d-rh-rechts
385/165 s-lh-links
elettrico, senza motorino
electric, without motor
elektrisch, ohne Motor

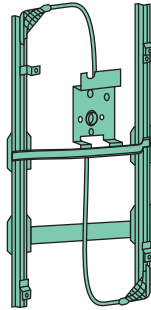

385/174 d-rh-rechts
385/175 s-lh-links
elettrico, con motorino
electric, with motor
elektrisch, mit Motor

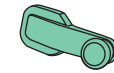
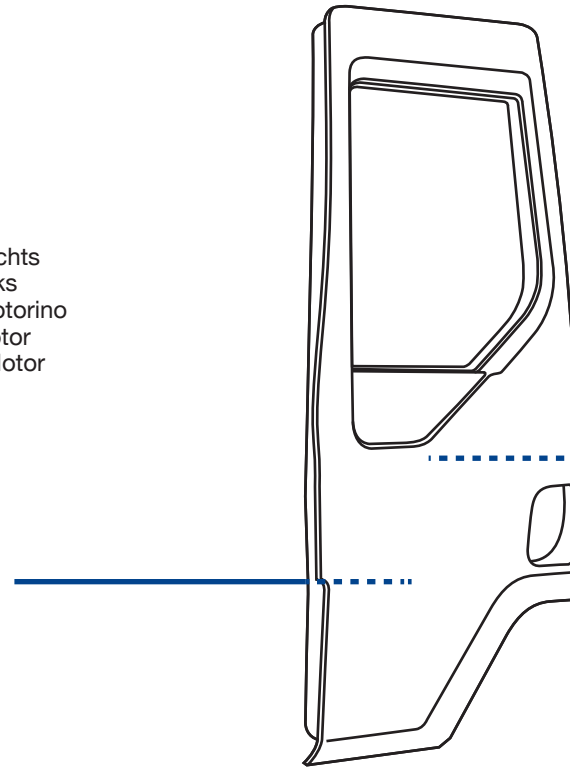
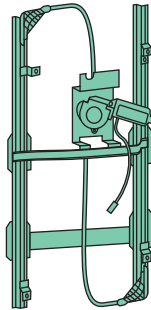

0FM/170
d|s-rh|lh-rechts|links



385/164
O.E.M. -
385/165
O.E.M. -



385/166
O.E.M. 82497192
385/167
O.E.M. 82497191



385/174
O.E.M. 22189861
385/175
O.E.M. 22189860



0FM/170
O.E.M. 8140016

applicabile a | suitable to | verwendbar für:

FL 2006



LF0/500

21326527
20743983



II (E4) 024104
202x337 mm



IV (E4) 024105
200x197 mm

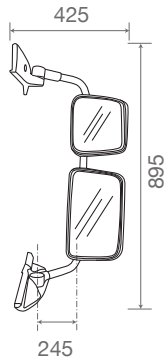

applicabilità:
applicable to:
Verwendbar für

VOLVO 0FL. FL 09/2006→
VOLVO 0FE. FE 09/2006→

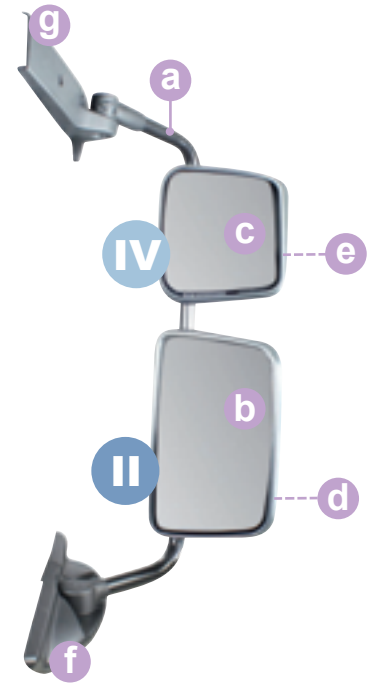

LF0/512

II



244x370 mm

LF0/510

IV



235x243 mm

COVIND

a PRM/508 20903727



+ **g**
323x895 mm

b PRM/504 20862795



E4 024104
202x337 mm

c LFO/504 20862815



E4 024105
200x197 mm

d LFO/506 20862779



241x369 mm

e LFO/507 20862800



235x241 mm

f PRM/512 20708230



g PRM/522 -



applicabile a | suitable to | verwendbar für:

FL 2006



LF0/501

20707881



II

(E4) 024104

202x337 mm



IV

(E4) 024105

200x197 mm

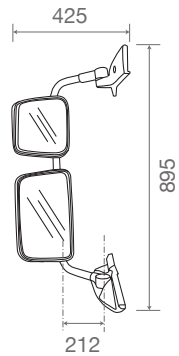

applicabilità:
applicable to:
Verwendbar für

VOLVO 0FL. FL 09/2006→
VOLVO 0FE. FE 09/2006→

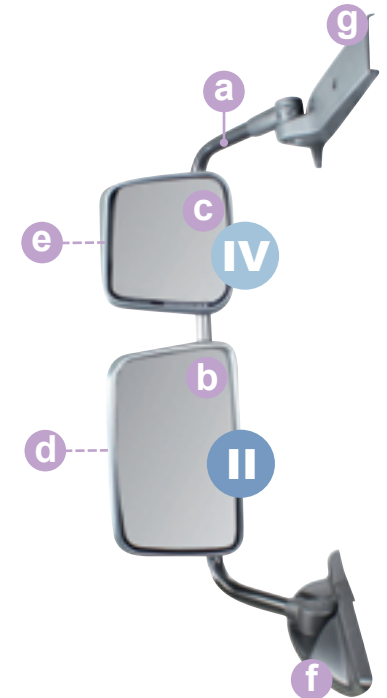

LF0/513

-



241x370 mm

LF0/511

-



234x245 mm

COVIND

a PRM/509

20903722



+ **g**
300x895 mm

b PRM/504

20862795



E4 024104
202x337 mm

II

c LFO/505

20862810



E4 024105
200x197 mm

IV

d LFO/506

20862779



241x369 mm

II

e LFO/507

20862800



235x241 mm

IV

f PRM/513

20708110



g PRM/523

-



a LFO/508 20903732



+ **g**
387x895 mm

b PRM/504 20862795



E4 024104
202x337 mm

II

c LFO/504 20862815



E4 024105
200x197 mm

IV

d LFO/506 20862779



241x369 mm

II

e LFO/507 20862800



235x241 mm

IV

f PRM/512 20708230



g PRM/522 -



applicabile a | suitable to | verwendbar für:

FL 2006



LF0/503

20707874



II (E4) 024104
202x337 mm



IV (E4) 024105
200x197 mm

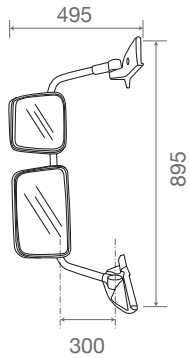

applicabilità:
applicable to:
Verwendbar für

VOLVO 0FE. FE 09/2006→
VOLVO 0FL. FL 09/2006→

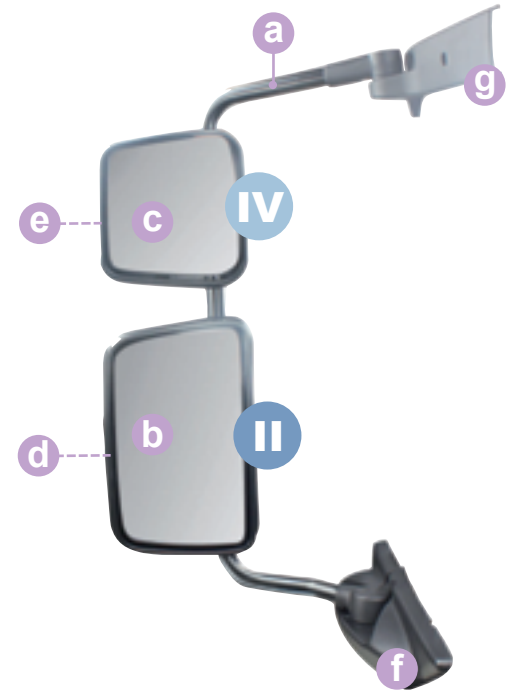

LF0/513

-



241x370 mm

LF0/511

-



234x245 mm

COVIND
II
IV

a LFO/509 20903723



+ **g**
387x895 mm

b PRM/504 20862795



E4 024104
202x337 mm

II

c LFO/505 20862810

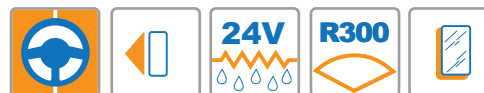

E4 024105
200x197 mm

IV

d LFO/506 20862779



241x369 mm

II

e LFO/507 20862800



235x241 mm

IV

f PRM/513 20708110



g PRM/523 -



applicabile a | suitable to | verwendbar für:

FL 2006

ZOOM

MDL/508

78493162
(84561115)
(84531138)
(20707812)

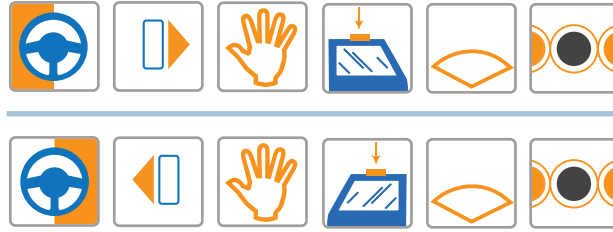

V E9 026320
255x150 mm

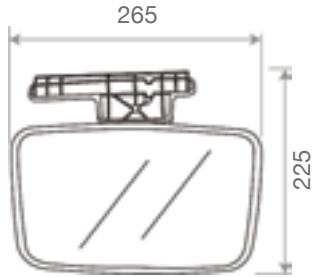

applicabilità:
applicable to:
Verwendbar für

VOLVO 0FL. FL 2006
VOLVO 0FE. FE 2006





FL 2006

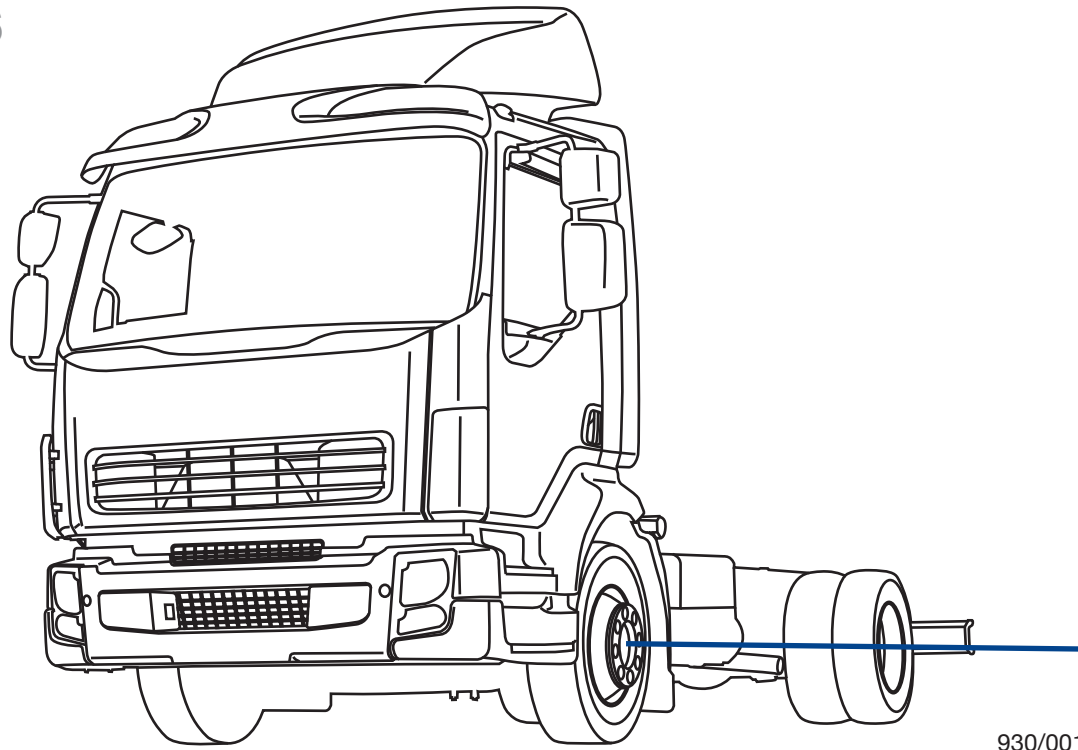

930/033

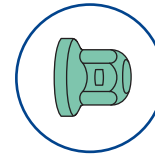

930/001 d-rh-rechts
930/002 s-lh-links



930/200
d|s-rh|lh
rechts|links

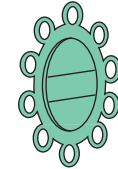

930/100 d-rh-rechts
930/101 s-lh-links



930/033
O.E.M. -



930/001
O.E.M. -
930/002
O.E.M. -



930/100
O.E.M. -
930/101
O.E.M. -



930/200
O.E.M. -

930/033-Tappo copri Bullone-Bolt cover-Radmutterkappen

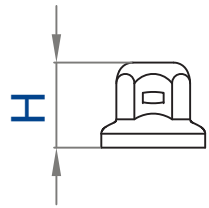

H	45 mm
Per bulloni \varnothing - bolt \varnothing	33 mm
Schlüsselweite \varnothing	
Colore	cromato-chrome-verchromt
Colours-Farbe	
Materiale-Material	acciaio inox-stainless steel Edelstahl
Kg	0,025

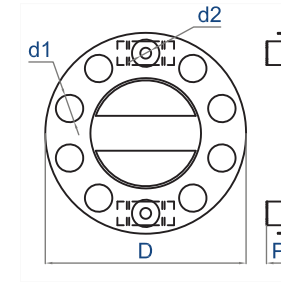

930/001 d-rh-rechts | 930/002 s-lh-links

D \varnothing 425 mm	P 50 mm
d1 nr. 10	d1 \varnothing 58 mm
d2 nr. 2	d2 \varnothing 23 mm
Ventilata	si-yes-Ja
Ventilated-Belüftet	
Colore	cromato e nero-chrome and black verchromt und schwarz
Colours-Farbe	
Materiale-Material	acciaio inox e plastica stainless steel and plastic Edelstahl und Kunststoff
Kg	1,230

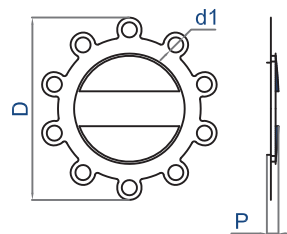

930/100 d-rh-rechts | 930/101 s-lh-links

D \varnothing 387 mm	P 30 mm
d1 nr. 10	d1 \varnothing 32 mm
Ventilata	si-yes-Ja
Ventilated-Belüftet	
Colore	cromato e nero-chrome and black verchromt und schwarz
Colours-Farbe	
Materiale-Material	acciaio inox e plastica stainless steel and plastic Edelstahl und Kunststoff
Kg	0,655

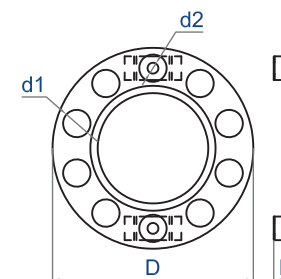

930/200 d|s-rh|lh-rechts+links

D \varnothing 425 mm	P 40 mm
d1 nr. 10	d1 \varnothing 58 mm
d2 nr. 2	d2 \varnothing 23 mm
Ventilata	no-nein
Ventilated-Belüftet	
Colore	cromato-chrome-verchromt
Colours-Farbe	
Materiale-Material	acciaio inox-stainless steel Edelstahl
Kg	1,155

applicabile a | suitable to | verwendbar für:

FL 2006

XF0/670

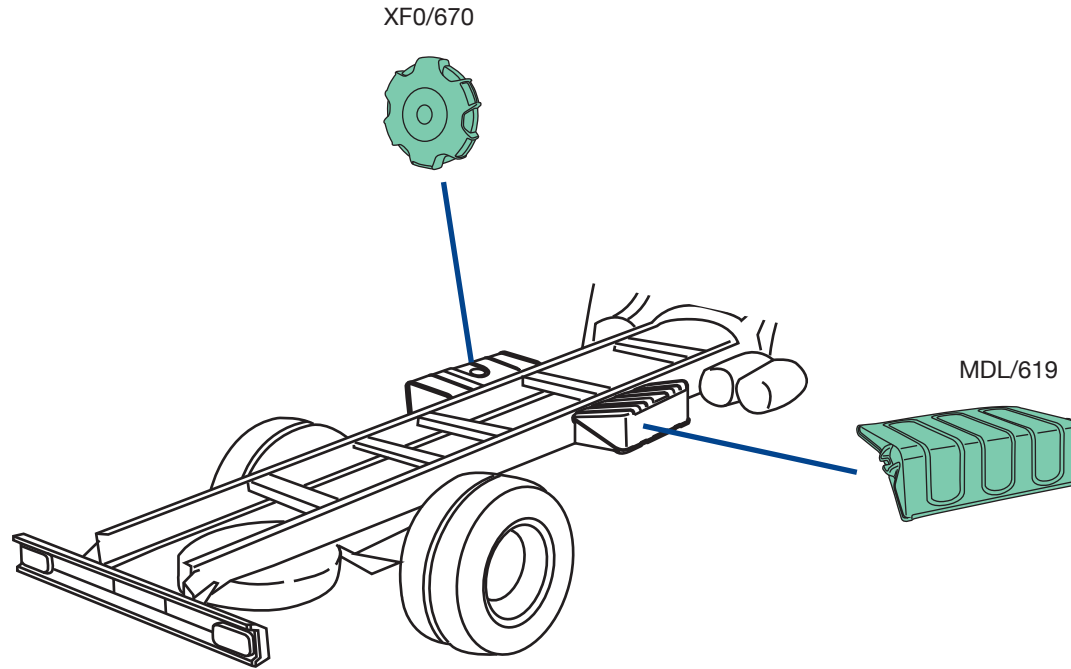
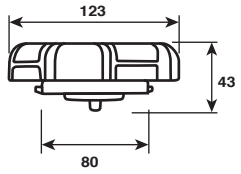

XF0/670
O.E.M. -



MDL/619
O.E.M. 20947987



applicabile a | suitable to | verwendbar für

21

OFE

FE 2006 (2006→2012)

applicabile a | suitable to | verwendbar für:

FE 2006



OFE/400

20937431
20501225

materiale | material | material PMMA - Acrylglas

peso | weight | Gewicht 5,120 Kg

applicabilità | suitable to | für
VOLVO FE. FE 2006
VOLVO FL. FL 2006
VOLVO VM.

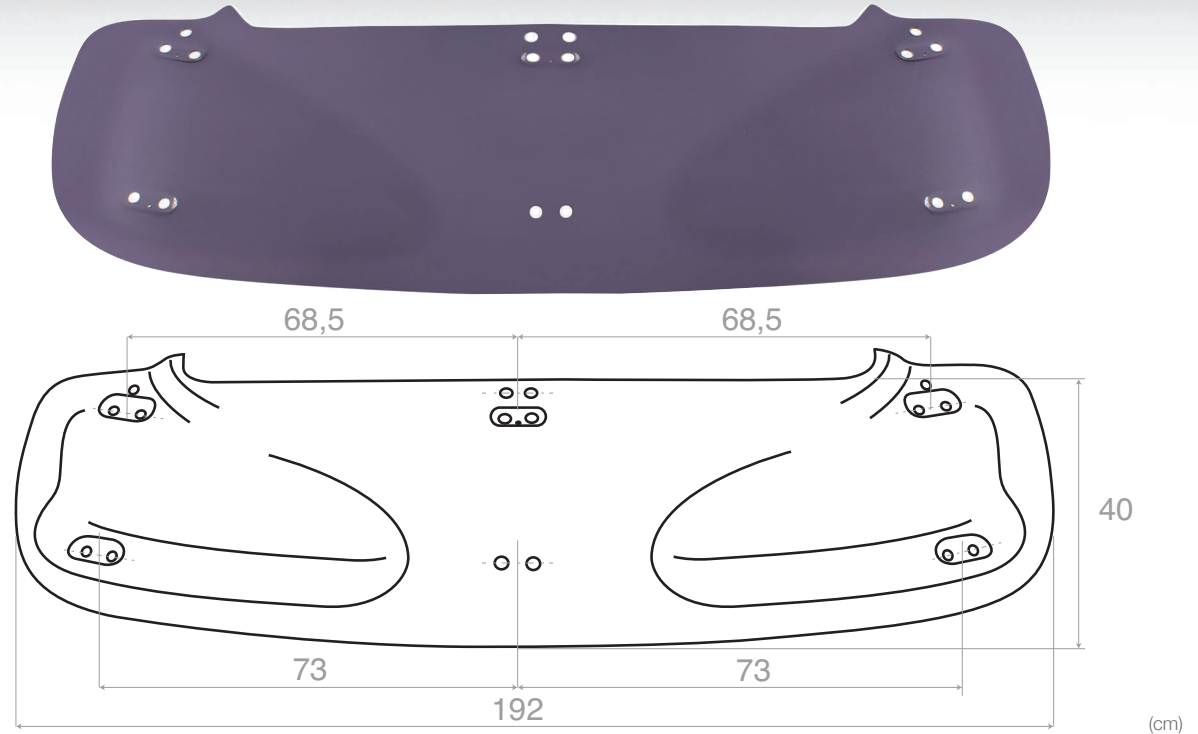

extra



COVIND

0FL/400 20937442
20743944

materiale | material | material PMMA - Acrylglas

peso | weight | Gewicht 5,315 Kg

applicabilità | suitable to | für
VOLVO FE. FE 2006
VOLVO FL. FL 2006
VOLVO VM.

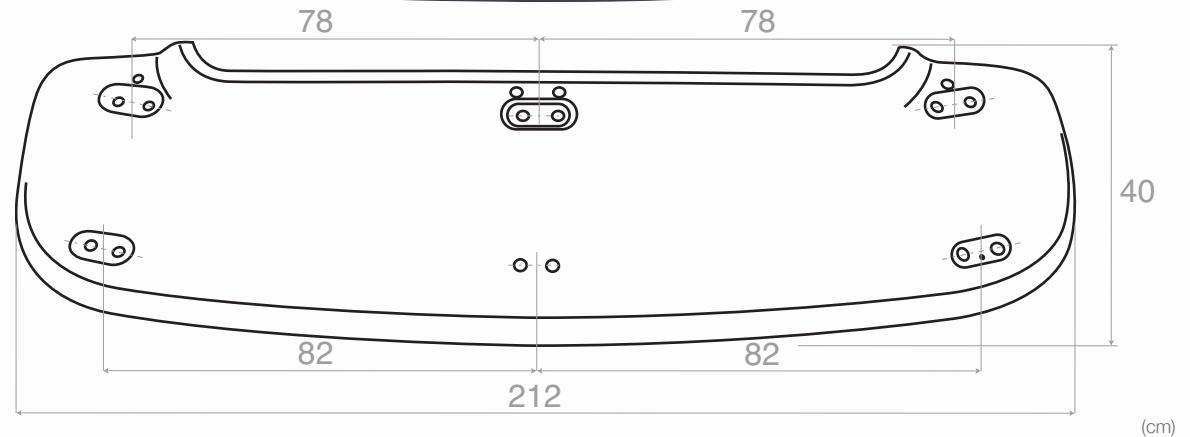
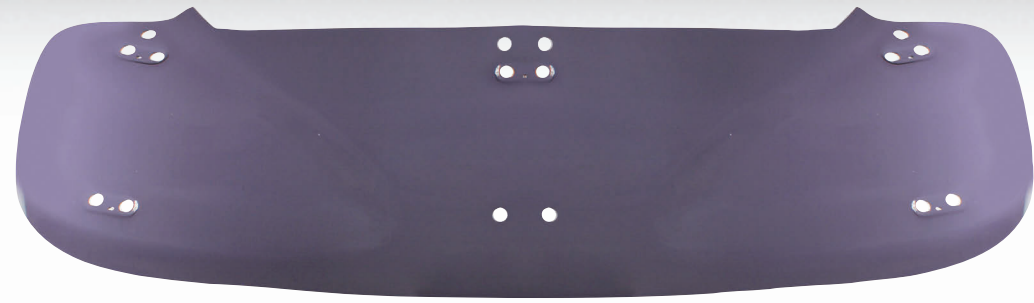

extra



385/480 20819179

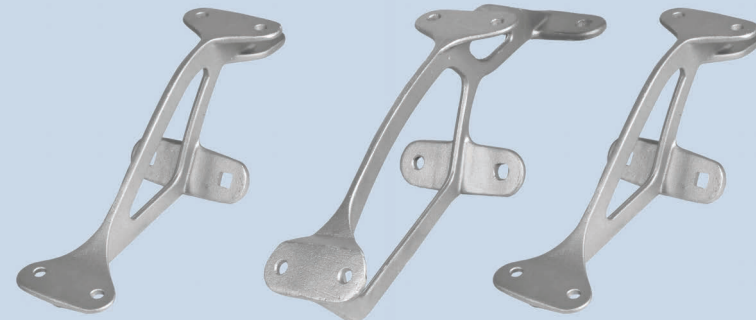

applicabile a | suitable to | verwendbar für:

FE 2006

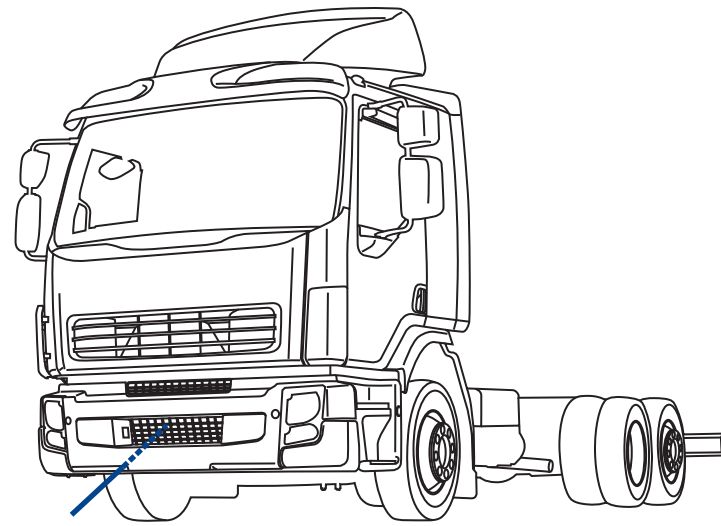

PRM/ 98



PRM/ 99

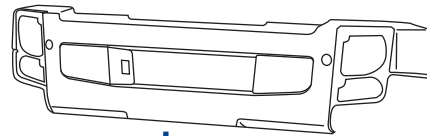
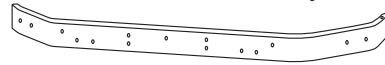
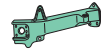

PRM/103

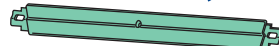

PRM/105



PRM/104



PRM/ 98
O.E.M. 82317469
PRM/ 99
O.E.M. 82317468



PRM/103
O.E.M. 25369343
PRM/104
O.E.M. 25369342



PRM/105
O.E.M. 25369341

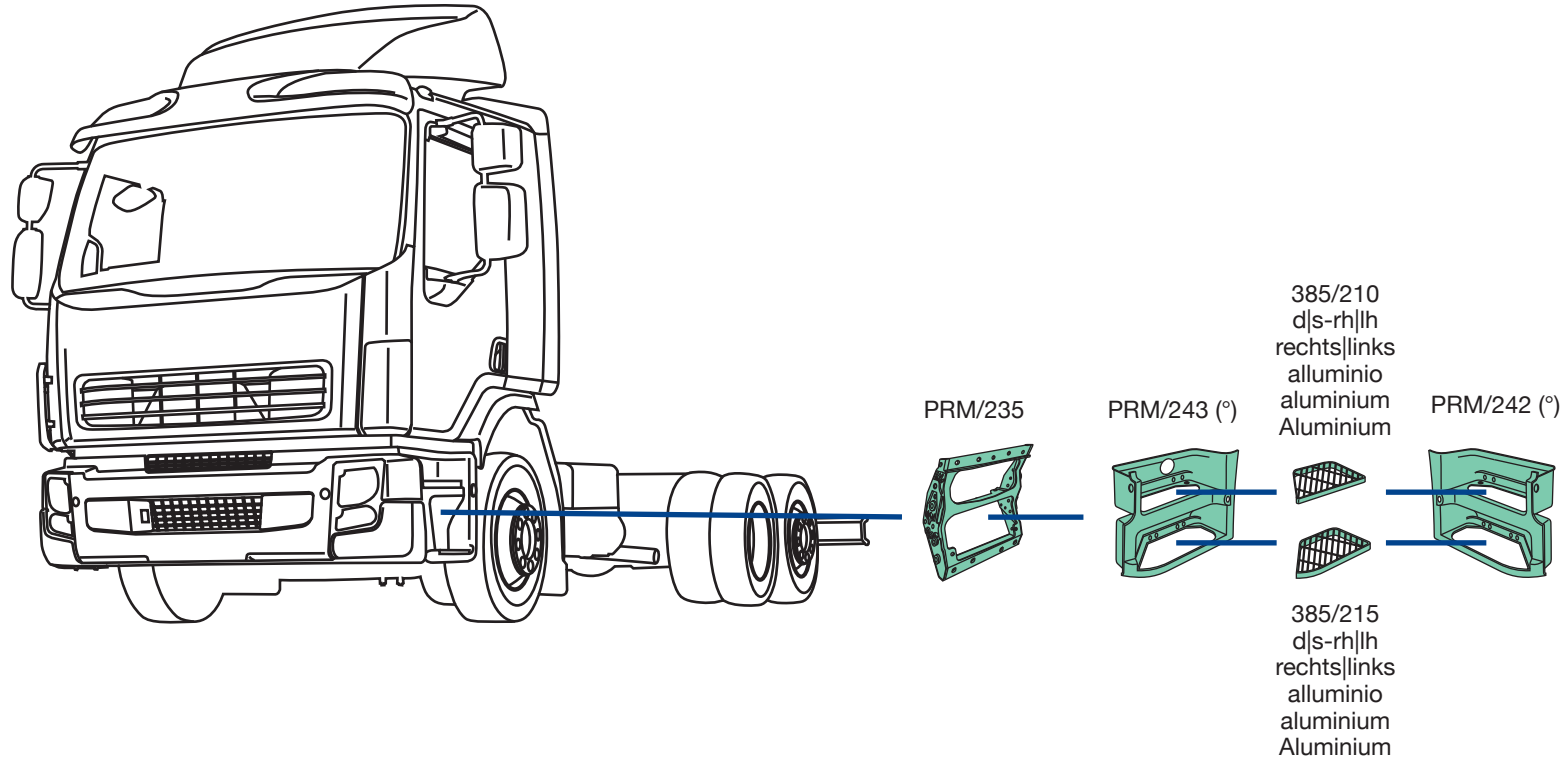

385/210
O.E.M. -



385/215
O.E.M. -



PRM/235
O.E.M. 21087113



PRM/242
O.E.M. 20593735



PRM/243
O.E.M. 20593721

FE 2006

(*) vernice di fondo | unprocessed | grundiert

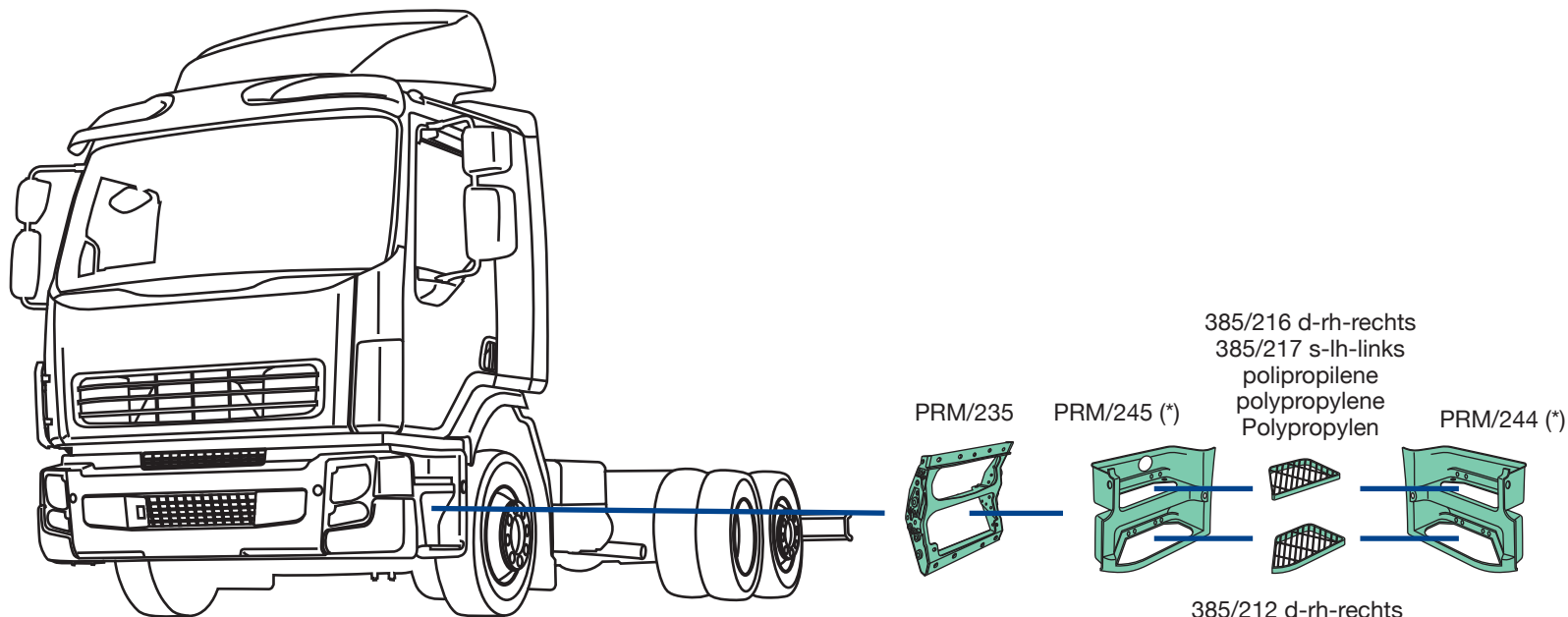

385/212
O.E.M. 20538011
385/213
O.E.M. 20538012



385/216
O.E.M. 20538248
385/217
O.E.M. 20538247



PRM/235
O.E.M. 21087113



PRM/244
O.E.M. 5010578387



PRM/245
O.E.M. 5010578381

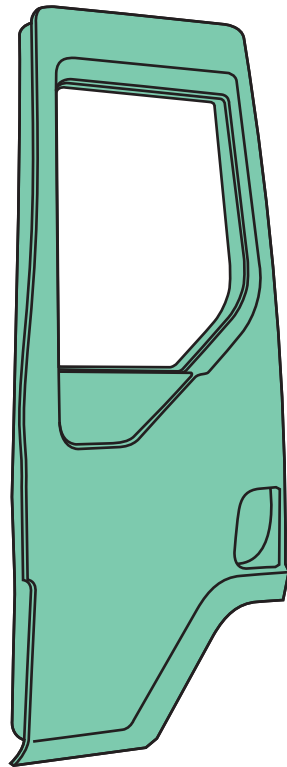

LF0/ 2 d-rh-rechts
LF0/ 3 s-lh-links
senza cerniere
without hinges
ohne Türscharniere

385/ 6
superiore sinistro
upper lh-oben links
inferiore destro
lower rh-Unten rechts

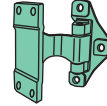

385/ 7
superiore destro
upper rh-oben rechts
inferiore sinistro
lower lh-Unten links

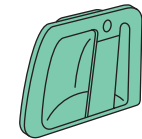
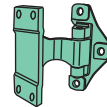

385/194 d-rh-rechts
385/195 s-lh-links



LF0/ 2
O.E.M. 85112767
LF0/ 3
O.E.M. 85112766



385/ 6
O.E.M. 20555723



385/ 7
O.E.M. 20555722



385/194
O.E.M. 24426875
385/195
O.E.M. 24426873

FE 2006

	385/164 d-rh-rechts	385/174 d-rh-rechts
	385/165 s-lh-links	385/175 s-lh-links
385/166 d-rh-rechts	elettrico, senza motorino	elettrico, con motorino
385/167 s-lh-links	electric, without motor	electric, with motor
manuale-manual-manuell	elektrisch, ohne Motor	elektrisch, mit Motor

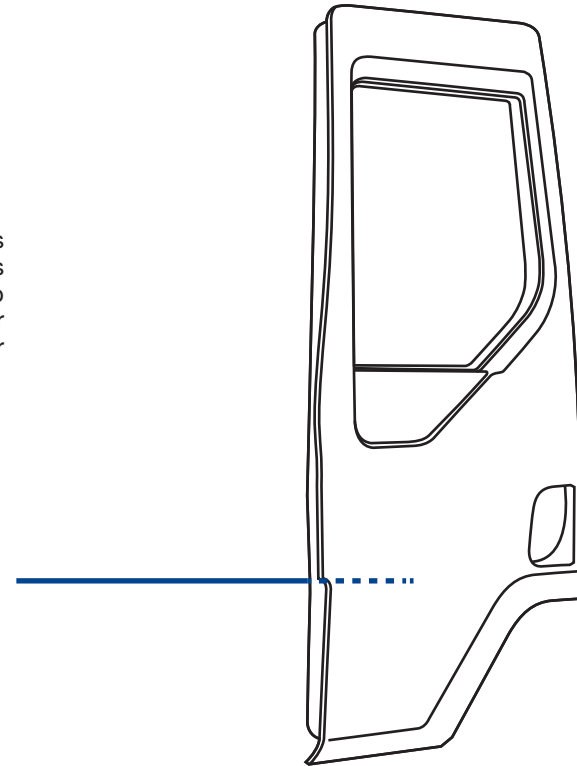
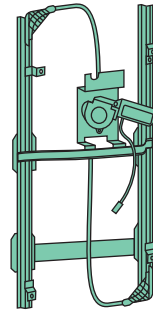
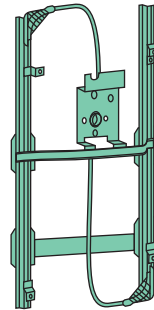
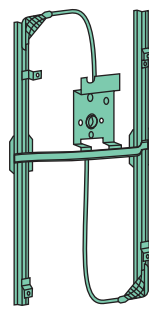

385/164
O.E.M. -
385/165
O.E.M. -

385/166
O.E.M. 82497192
385/167
O.E.M. 82497191

385/174
O.E.M. 22189861
385/175
O.E.M. 22189860



applicabile a | suitable to | verwendbar für:

FE 2006



LF0/500

21326527
20743983



II (E4) 024104
202x337 mm



IV (E4) 024105
200x197 mm

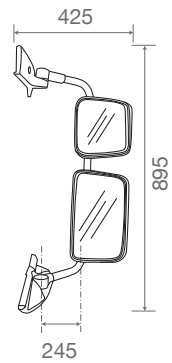

applicabilità:
applicable to:
Verwendbar für

VOLVO 0FL. FL 09/2006→
VOLVO 0FE. FE 09/2006→

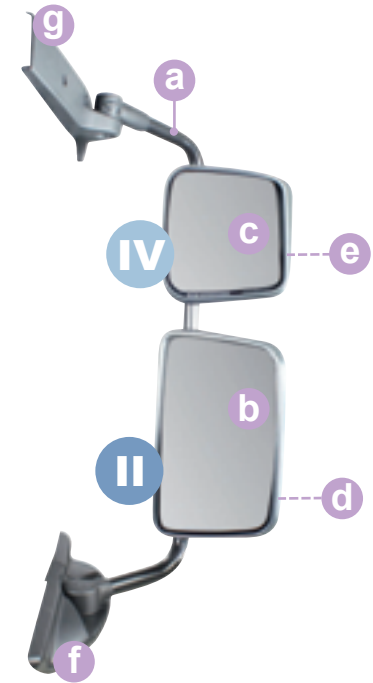

LF0/512

II

LF0/510















IV



244x370 mm



235x243 mm

<p>a PRM/508</p>	<p>20903727</p>			<p>+ g 323x895 mm</p>
<p>b PRM/504</p> <p>II</p>	<p>20862795</p>			<p>E4 024104 202x337 mm</p>
<p>c LFO/504</p> <p>IV</p>	<p>20862815</p>			<p>E4 024105 200x197 mm</p>
<p>d LFO/506</p> <p>II</p>	<p>20862779</p>			<p>241x369 mm</p>
<p>e LFO/507</p> <p>IV</p>	<p>20862800</p>			<p>235x241 mm</p>
<p>f PRM/512</p>	<p>20708230</p>			
<p>g PRM/522</p>	<p>-</p>			

applicabile a | suitable to | verwendbar für:

FE 2006



LF0/501

20707881



II (E4) 024104
202x337 mm



IV (E4) 024105
200x197 mm

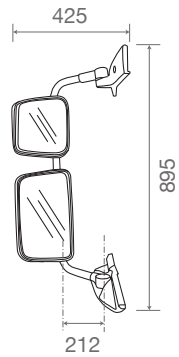

applicabilità:
applicable to:
Verwendbar für

VOLVO 0FL. FL 09/2006→
VOLVO 0FE. FE 09/2006→

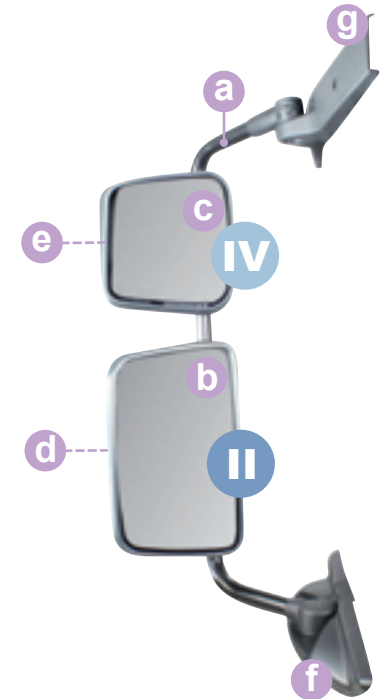

LF0/513

-



241x370 mm

LF0/511

-



234x245 mm

a PRM/509

20903722



+ **g**
300x895 mm

b PRM/504

20862795



E4 024104
202x337 mm

II

c LFO/505

20862810



E4 024105
200x197 mm

IV

d LFO/506

20862779



241x369 mm

II

e LFO/507

20862800



235x241 mm

IV

f PRM/513

20708110



g PRM/523

-



applicabile a | suitable to | verwendbar für:



FE 2006

LF0/502

21475603
20708303



II (E4) 024104
202x337 mm



IV (E4) 024105
200x197 mm

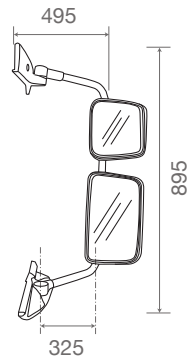

applicabilità:
applicabile to:
Verwendbar für

VOLVO OFE. FE 09/2006→
VOLVO OFL. FL 09/2006→

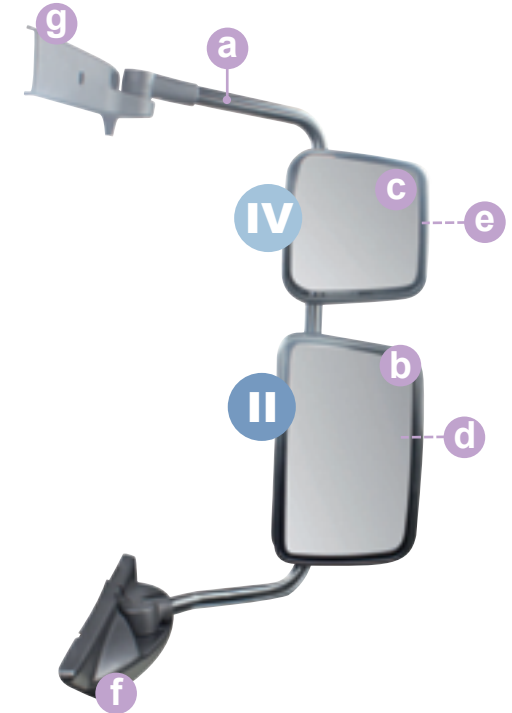

GOVIND
II
IV

LF0/512

-



244x370 mm

LF0/510

-



235x243 mm

a LFO/508 20903732



+ **g**
387x895 mm

b PRM/504 20862795



E4 024104
202x337 mm

II

c LFO/504 20862815



E4 024105
200x197 mm

IV

d LFO/506 20862779

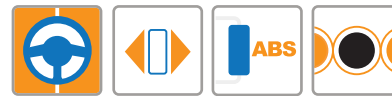

241x369 mm

II

e LFO/507 20862800



235x241 mm

IV

f PRM/512 20708230



g PRM/522 -



applicabile a | suitable to | verwendbar für:

FE 2006



LF0/503

20707874



II (E4) 024104
202x337 mm



IV (E4) 024105
200x197 mm

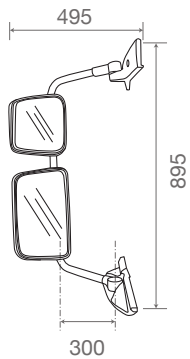

applicabilità:
applicable to:
Verwendbar für

VOLVO 0FE. FE 09/2006→
VOLVO 0FL. FL 09/2006→

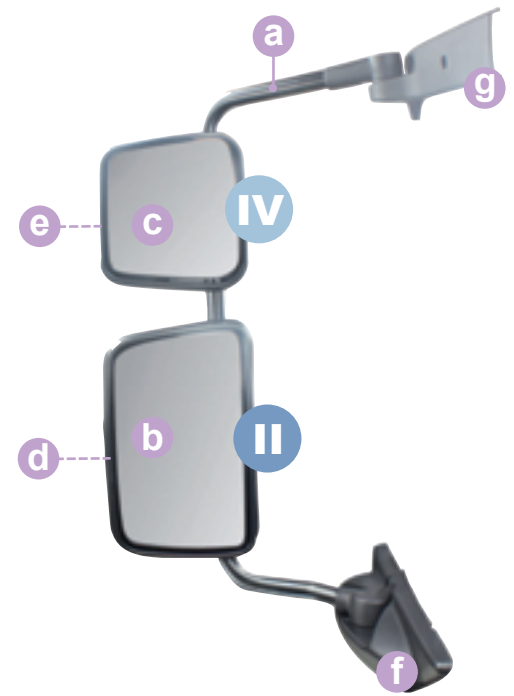

LF0/513

-



241x370 mm















LF0/511

-



234x245 mm

COVIND
II
IV

<p>a LFO/509</p>	<p>20903723</p>			<p>+ g 387x895 mm</p>
<p>b PRM/504</p> <p>II</p>	<p>20862795</p>			<p>E4 024104 202x337 mm</p>
<p>c LFO/505</p> <p>IV</p>	<p>20862810</p>			<p>E4 024105 200x197 mm</p>
<p>d LFO/506</p> <p>II</p>	<p>20862779</p>			<p>241x369 mm</p>
<p>e LFO/507</p> <p>IV</p>	<p>20862800</p>			<p>235x241 mm</p>
<p>f PRM/513</p>	<p>20708110</p>			
<p>g PRM/523</p>	<p>-</p>			

applicabile a | suitable to | verwendbar für:

FE 2006



MDL/508

78493162
(84561115)
(84531138)
(20707812)

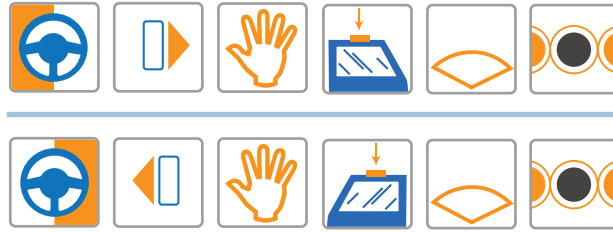

V E9 026320
255x150 mm

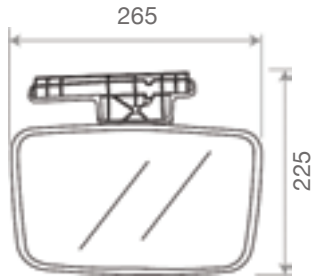

applicabilità:
applicable to:
Verwendbar für

VOLVO 0FL. FL 2006
VOLVO 0FE. FE 2006



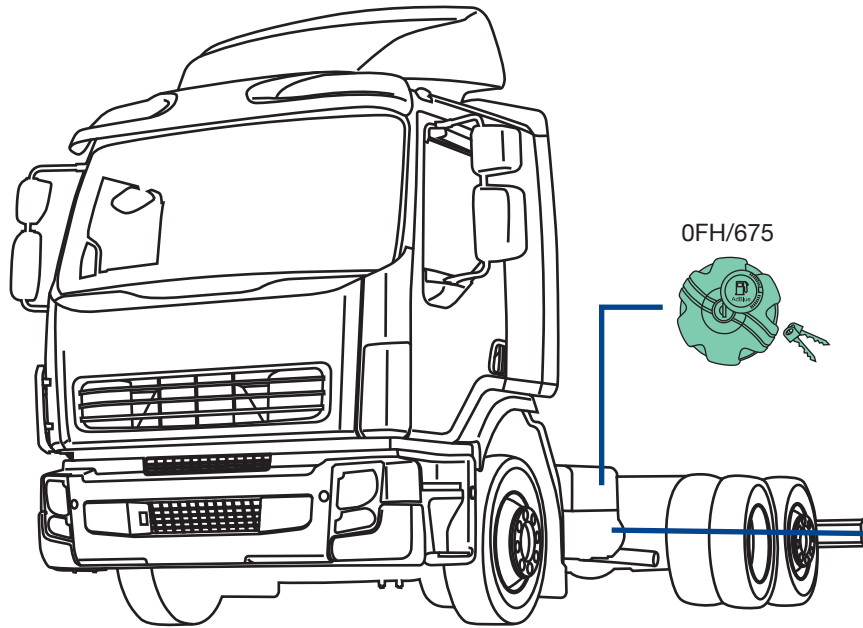

0FH/675

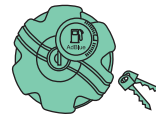

XF0/670

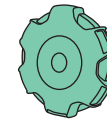

2FH/619

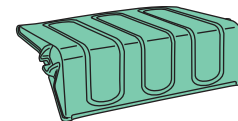
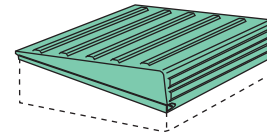

MDL/619

XF0/670

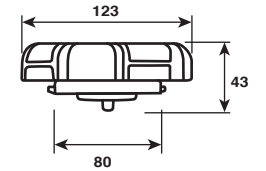

0FH/675

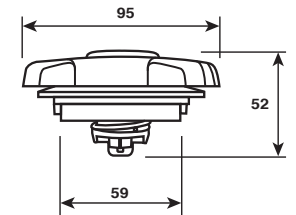

0FH/675
O.E.M. 21281403



2FH/619
O.E.M. 20507252



XF0/670
O.E.M. -



MDL/619
O.E.M. 20947987

FE 2006

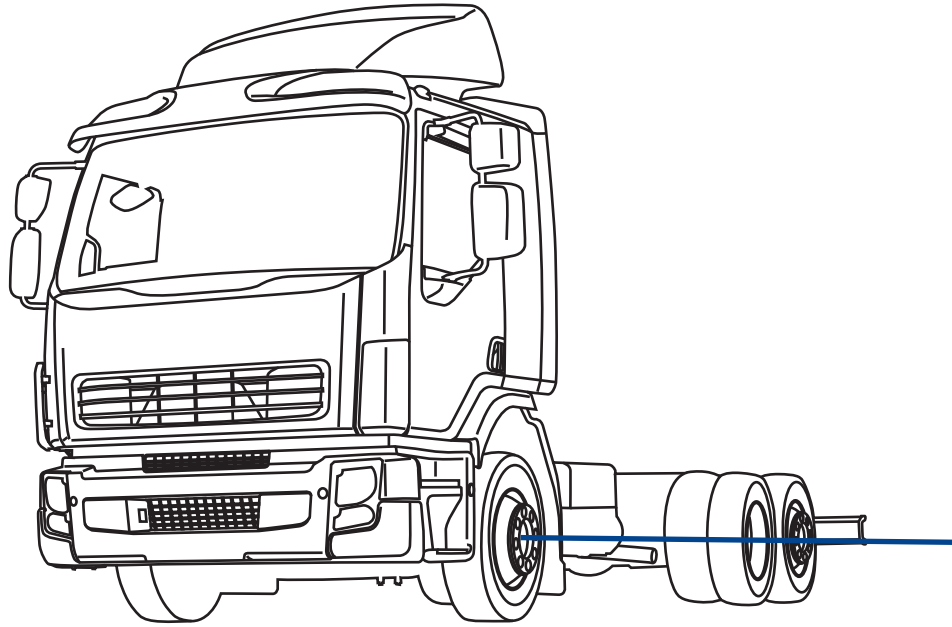

930/033

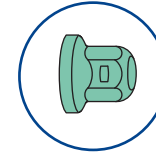

930/001 d-rh-rechts
930/002 s-lh-links



930/200
d|s-rh|lh
rechts|links

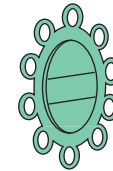

930/100 d-rh-rechts
930/101 s-lh-links



930/033
O.E.M. -



930/001
O.E.M. -
930/002
O.E.M. -



930/100
O.E.M. -
930/101
O.E.M. -



930/200
O.E.M. -

930/033-Tappo copri Bullone-Bolt cover-Radmutterkappen

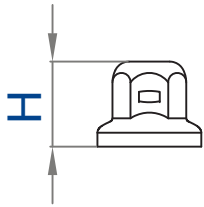

H	45 mm
Per bulloni \varnothing - bolt \varnothing	33 mm
Schlüsselweite \varnothing	
Colore	cromato-chrome-verchromt
Colours-Farbe	
Materiale-Material	acciaio inox-stainless steel Edelstahl
Kg	0,025

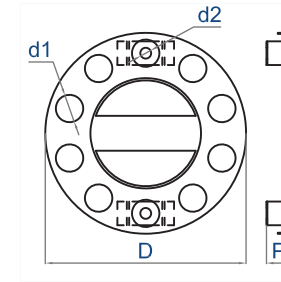

930/001 d-rh-rechts | 930/002 s-lh-links

D \varnothing 425 mm	P 50 mm
d1 nr. 10	d1 \varnothing 58 mm
d2 nr. 2	d2 \varnothing 23 mm
Ventilata	si-yes-Ja
Ventilated-Belüftet	
Colore	cromato e nero-chrome and black verchromt und schwarz
Colours-Farbe	
Materiale-Material	acciaio inox e plastica stainless steel and plastic Edelstahl und Kunststoff
Kg	1,230

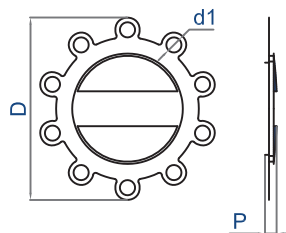

930/100 d-rh-rechts | 930/101 s-lh-links

D \varnothing 387 mm	P 30 mm
d1 nr. 10	d1 \varnothing 32 mm
Ventilata	si-yes-Ja
Ventilated-Belüftet	
Colore	cromato e nero-chrome and black verchromt und schwarz
Colours-Farbe	
Materiale-Material	acciaio inox e plastica stainless steel and plastic Edelstahl und Kunststoff
Kg	0,655

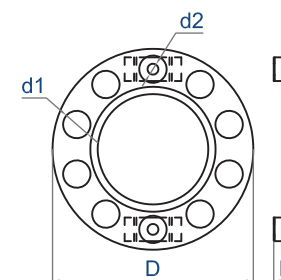

930/200 d|s-rh|lh-rechts+links

D \varnothing 425 mm	P 40 mm
d1 nr. 10	d1 \varnothing 58 mm
d2 nr. 2	d2 \varnothing 23 mm
Ventilata	no-nein
Ventilated-Belüftet	
Colore	cromato-chrome-verchromt
Colours-Farbe	
Materiale-Material	acciaio inox-stainless steel Edelstahl
Kg	1,155

applicabile a | suitable to | verwendbar für:

FE 2006

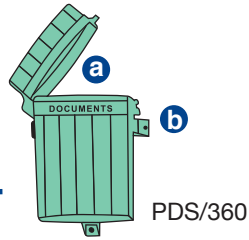
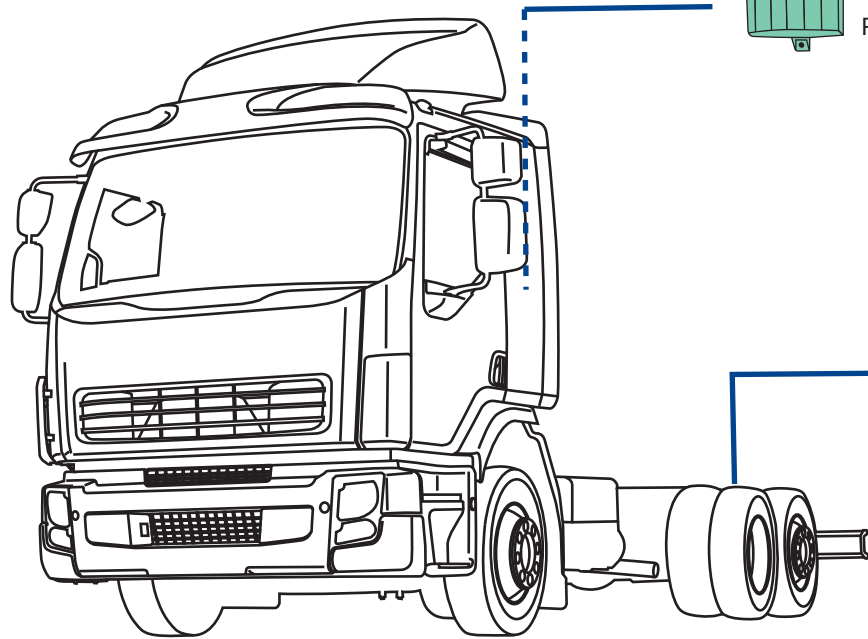

PDS/360

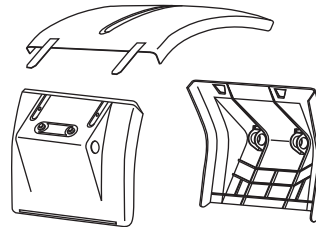

385/495 d-rh-rechts
385/494 s-lh-links

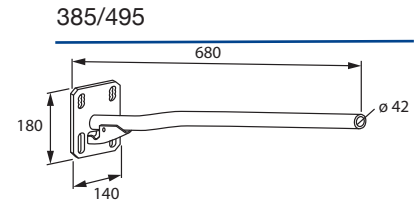
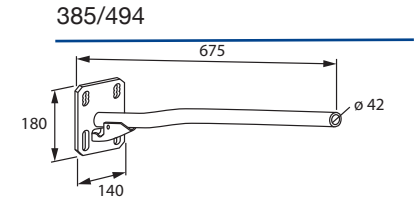

PDS/360

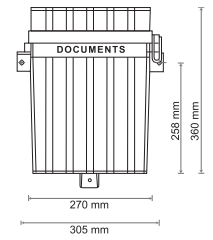

385/495
O.E.M. 21011689
385/494
O.E.M. 21011688



PDS/360
O.E.M. -

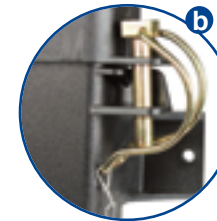



applicabile a | suitable to | verwendbar für

43

4FM
FM Euro 6 (2013→)

applicabile a | suitable to | verwendbar für:

FM Euro 6

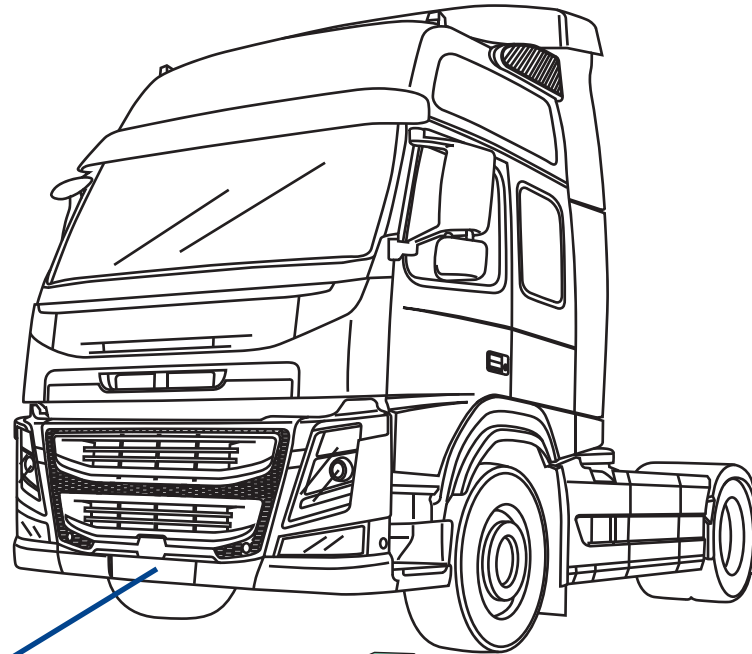

4FH/ 84
ferro-iron-Stahl

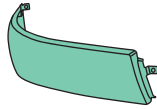

4FH/ 80
ferro-iron-Stahl

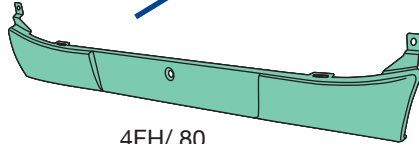

4FH/ 98 d-rh-rechts
4FH/ 99 s-lh-links

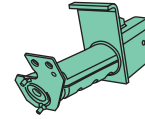

4FH/ 85
ferro-iron-Stahl

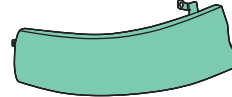

4FH/ 80
O.E.M. 22247766



4FH/ 84
O.E.M. 21838945
4FH/ 85
O.E.M. 21838944



4FH/ 98
O.E.M. 82943981
4FH/ 99
O.E.M. 82928883

(*) plastica, liscio, nero
plastic, smooth, black
Kunststoff, glatt, schwarz

(°) plastica, goffrato, grigio
plastic, textured, grey
Kunststoff, Geprägte, grau

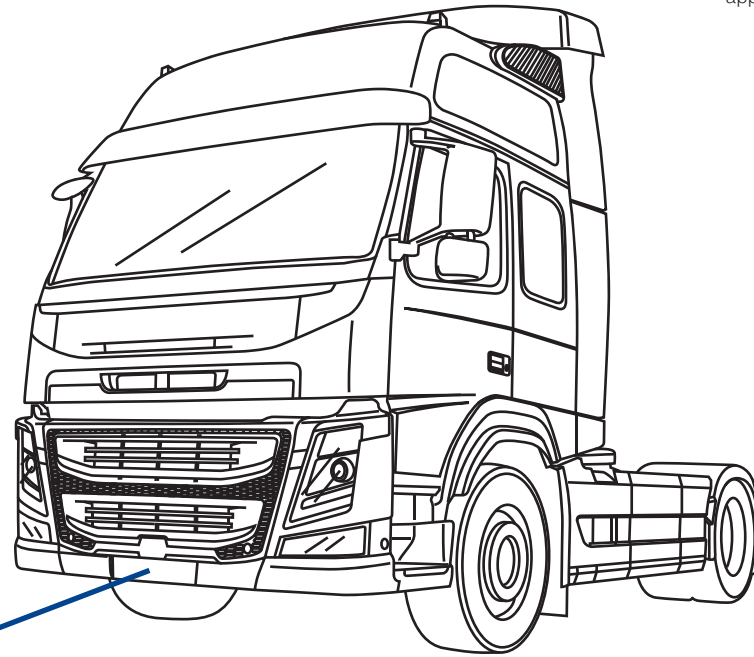

4FH/ 88 (*)
4FH/ 92 (°)

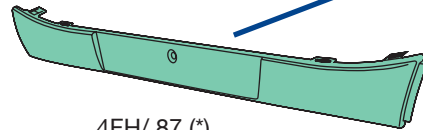
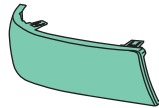

4FH/ 87 (*)
4FH/ 90 (°)



4FH/ 89 (*)
4FH/ 93 (°)



4FH/ 87
O.E.M. 84195623



4FH/ 88
O.E.M. 21413786
4FH/ 89
O.E.M. 21413789



4FH/ 90
O.E.M. 22249883



4FH/ 92
O.E.M. 21316577
4FH/ 93
O.E.M. 21316575

applicabile a | suitable to | verwendbar für:

FM Euro 6

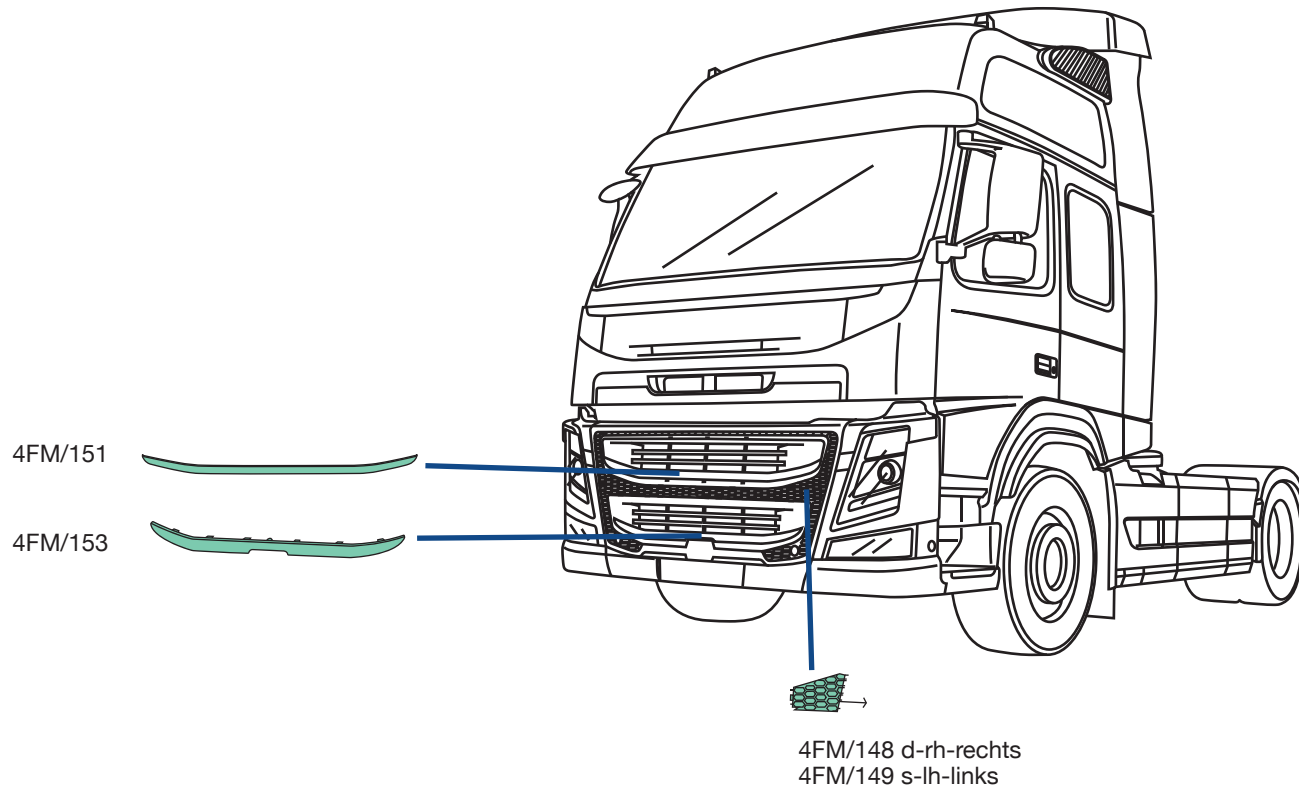

4FM/148
O.E.M. 82454671
4FM/149
O.E.M. 82444204

4FM/151
O.E.M. 82454672

4FM/153
O.E.M. 82455156

FM Euro 6

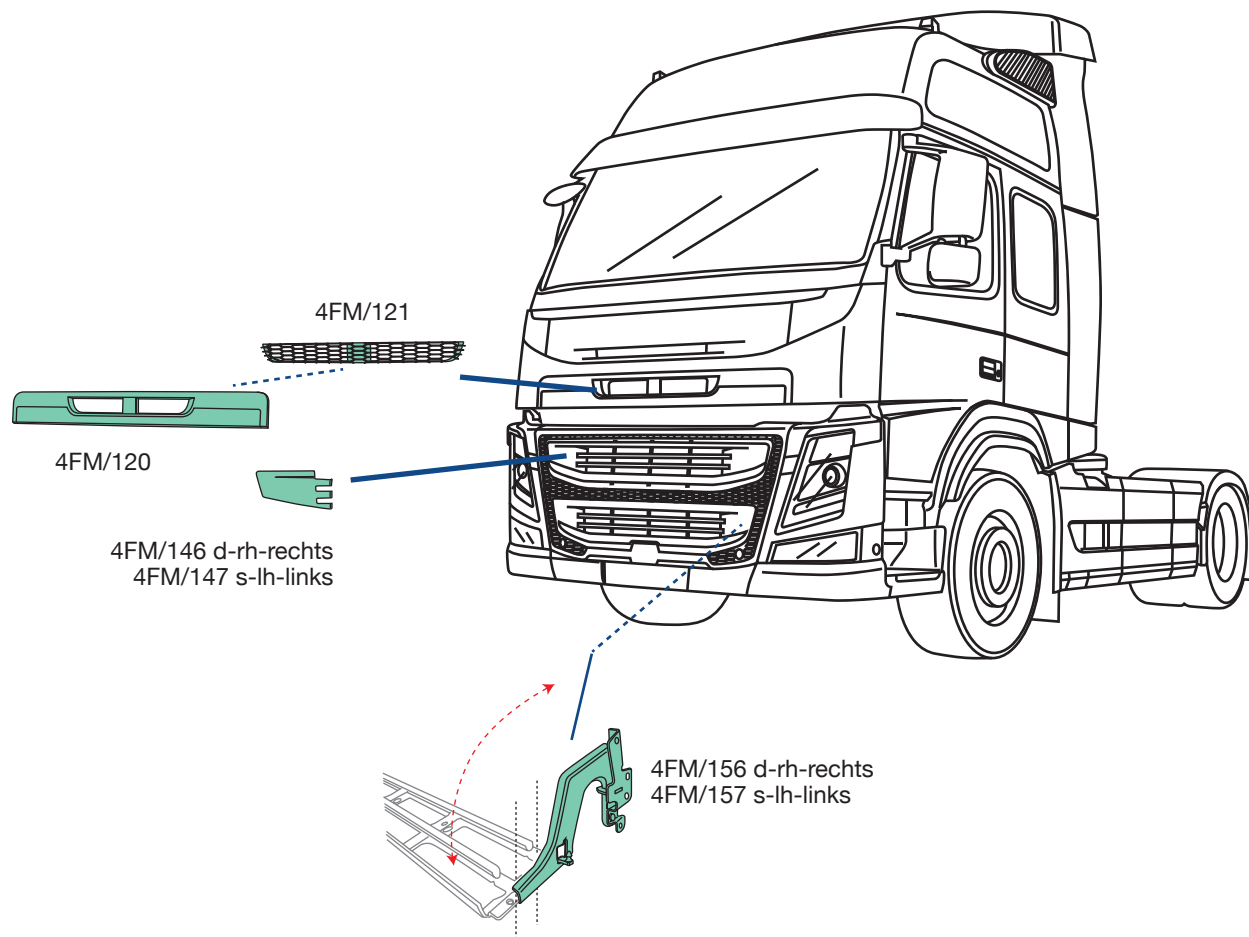

4FM/120
O.E.M. 84162402



4FM/121
O.E.M. 84167413



4FM/146
O.E.M. 82410206
4FM/147
O.E.M. 82409793



4FM/156
O.E.M. 84104144
4FM/157
O.E.M. 84104142

applicabile a | suitable to | verwendbar für:

FM Euro 6

4FH/136 d-rh-rechts | 4FH/138 s-lh-links

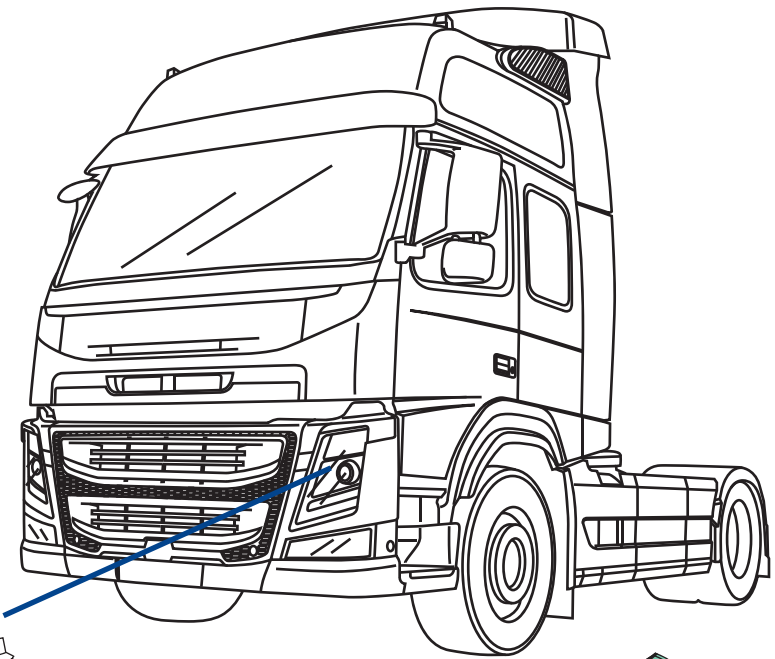
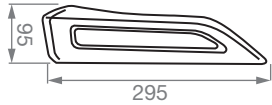

4FH/131 d-rh-rechts
4FH/132 s-lh-links

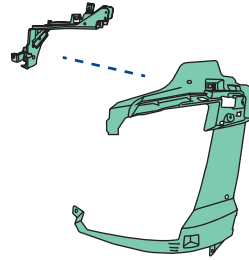

4FM/128 d-rh-rechts
4FM/129 s-lh-links

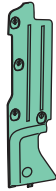

4FM/132 d-rh-rechts
4FM/133 s-lh-links

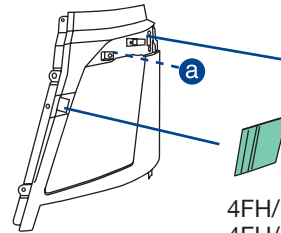

4FH/124 d-rh-rechts
4FH/125 s-lh-links



4FH/136 d-rh-rechts
4FH/138 s-lh-links

4FH/126 d-rh-rechts
4FH/127 s-lh-links



4FH/124
O.E.M. 82453926
4FH/125
O.E.M. 82446592

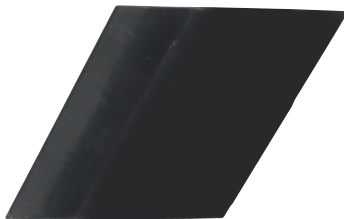

4FH/126
O.E.M. 21413774
4FH/127
O.E.M. 21413734



4FM/128
O.E.M. 82426187
4FM/129
O.E.M. 82426186



4FH/131
O.E.M. 84058023
4FH/132
O.E.M. 84046776



4FH/136
O.E.M. 23386781
4FH/138
O.E.M. 23386782



4FM/132
O.E.M. 84028392
4FM/133
O.E.M. 84027783

4FH/600 d-rh-rechts | 4FH/601 s-lh-links

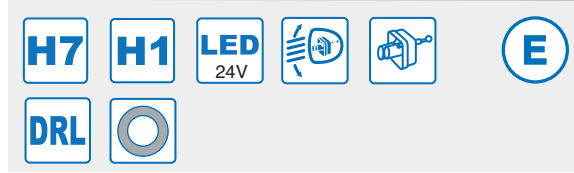

4FH/606 d-rh-rechts | 4FH/607 s-lh-links

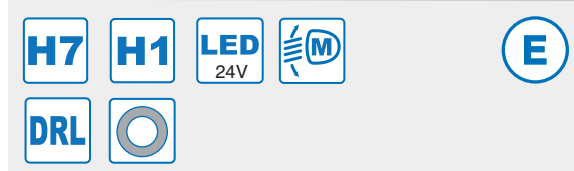

4FH/608 d-rh-rechts | 4FH/609 s-lh-links

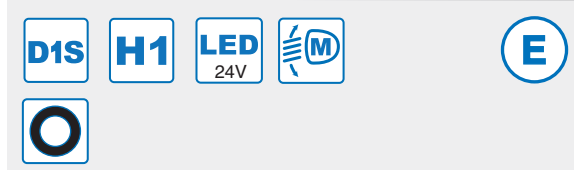

applicabile a | suitable to | verwendbar für:

FM Euro 6

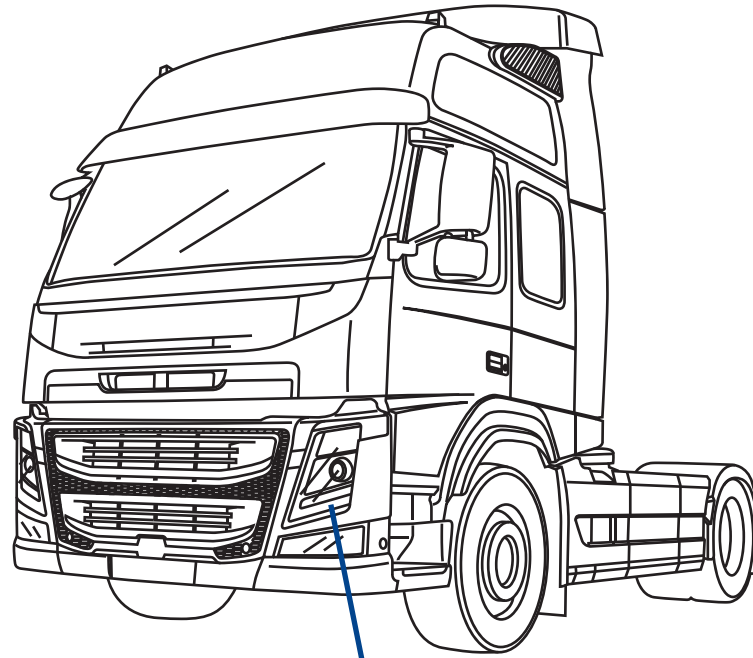

4FH/600 d-rh-rechts
 4FH/601 s-lh-links
 4FH/606 d-rh-rechts
 4FH/607 s-lh-links
 4FH/608 d-rh-rechts
 4FH/609 s-lh-links



9 pins

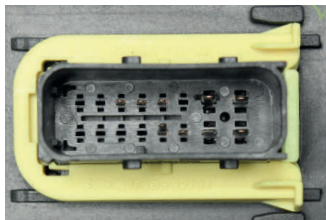

4FH/600
 O.E.M. 22239220
 4FH/601
 O.E.M. 22239221



7 pins

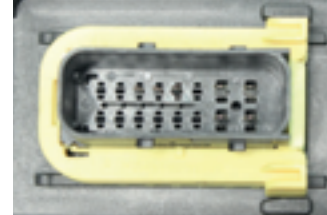

4FH/606
 O.E.M. 22239217
 4FH/607
 O.E.M. 22239219



8 pins



4FH/608
 O.E.M. 22239248
 4FH/609
 O.E.M. 22239250

applicabile a | suitable to | verwendbar für:

FM Euro 6

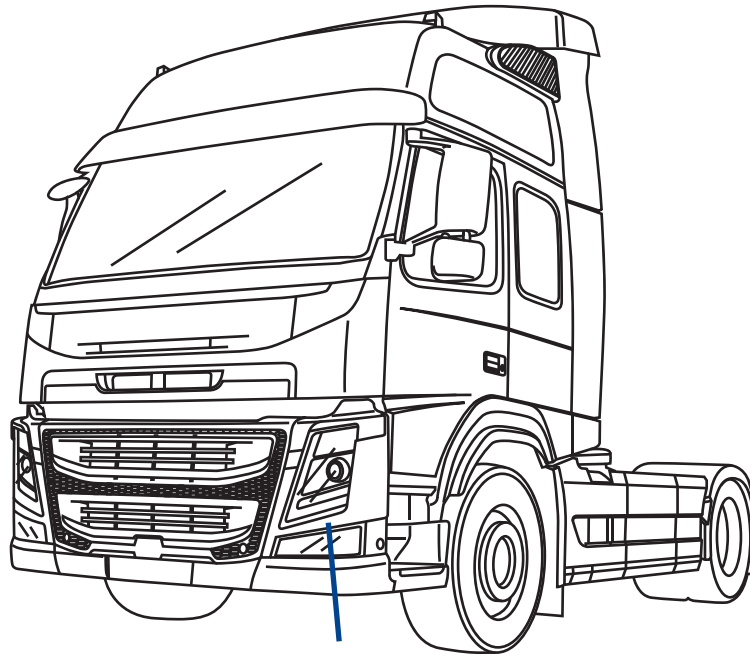

4FH/604 d-rh-rechts | 4FH/605 s-lh-links 2013 →

H7	H1	LED 24V		E
DRL				

4FH/702 d-rh-rechts | 4FH/703 s-lh-links

H7	H1		CON LUCE DI PROFONDITÀ WITH HIGH BEAM MIT FERNLICHT	E
-----------	-----------	--	---	----------

4FH/708 d-rh-rechts | 4FH/709 s-lh-links

H7		E
-----------	--	----------

4FH/604 d-rh-rechts
4FH/605 s-lh-links



4FH/702 d-rh-rechts
4FH/703 s-lh-links
4FH/708 d-rh-rechts
4FH/709 s-lh-links



7 pins



4FH/604
O.E.M. 22239225
4FH/605
O.E.M. 22239226



4FH/702
O.E.M. 22332594
4FH/703
O.E.M. 22332595



4FH/708
O.E.M. 22332592
4FH/709
O.E.M. 22332593

FM Euro 6

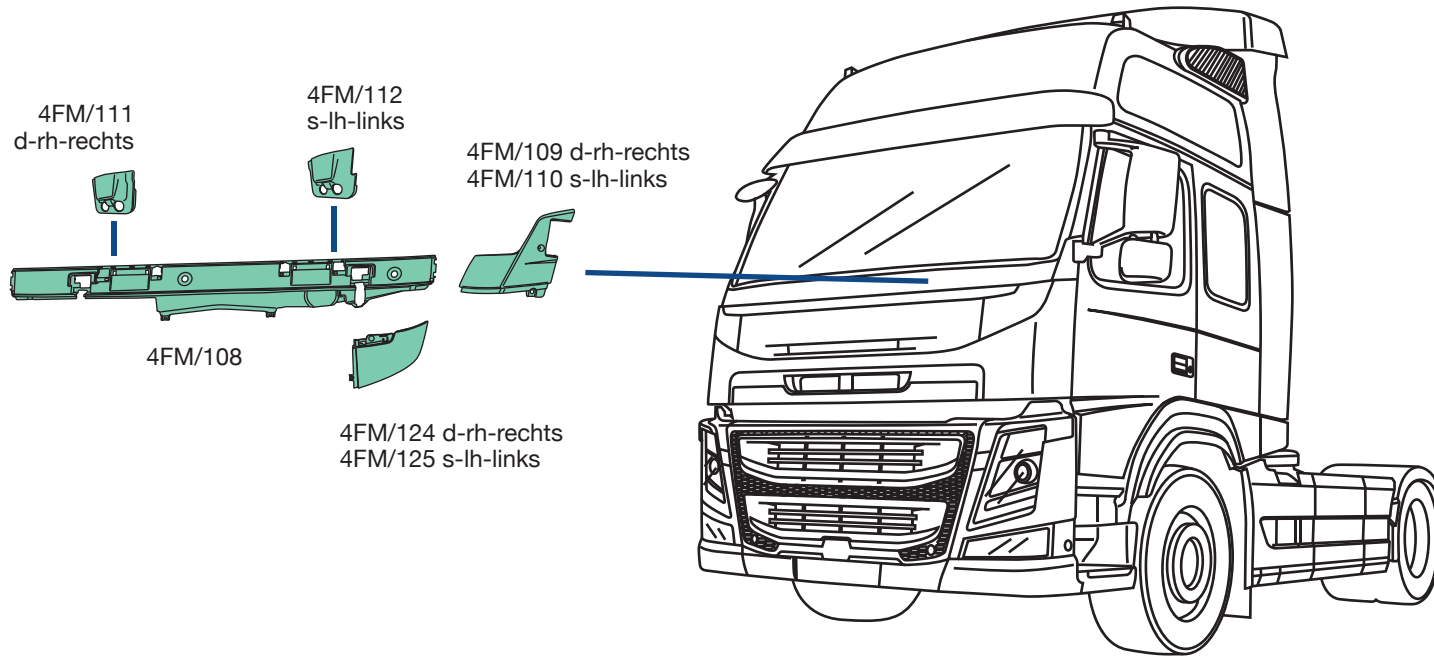

4FM/108
O.E.M. 82439937



4FM/109
O.E.M. 84448104
4FM/110
O.E.M. 82448110



4FM/111
O.E.M. 84151824



4FM/112
O.E.M. 84151777



4FM/124
O.E.M. 82430057
4FM/125
O.E.M. 82430056

applicabile a | suitable to | verwendbar für:



FM Euro 6

3FH/504

22286155



II

E4 024111

200x435 mm



IV

E4 0244639

200x185 mm

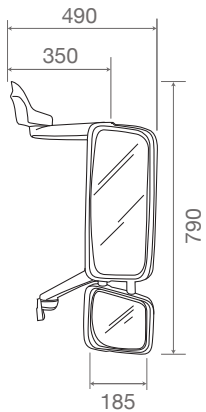

applicabilità:
applicable to:
Verwendbar für

VOLVO 3FH. FH III
VOLVO 3FM. FM III
VOLVO 4FM. FM euro 6



COVIND
II
IV

3FH/506



240x235 mm

a

-

-

b

2FH/503

21320404
(20589788)



E4 024111
200x435 mm

II

c

3FH/509

21320365
(21070768)
(20589798)



E4 0244639
200x185 mm

IV

d

3FH/511

21169974
(20746402)



187x435 mm

II

e

3FH/508

20841436



240x210 mm

IV

applicabile a | suitable to | verwendbar für:

FM EURO 6



3FH/505

22286149



II

E4 024111

200x435 mm



IV

E4 0244639

176x188 mm

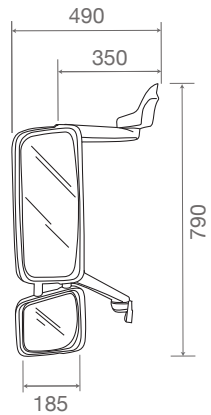

applicabilità:
applicable to:
Verwendbar für

VOLVO 3FH. FH III
VOLVO 3FM. FM III
VOLVO 4FM. FM euro 6



COVIND
II
3FH/507
IV



240x235 mm

a

-

b

2FH/503

21320404
(20589788)



E4 024111
200x435 mm

II

c

3FH/509

21320365
(21070768)
(20589798)



E4 0244639
185x200 mm

IV

d

3FH/511

21169974
(20746402)



187x435 mm

II

e

3FH/508

20841436



240x210 mm

IV

FM Euro 6

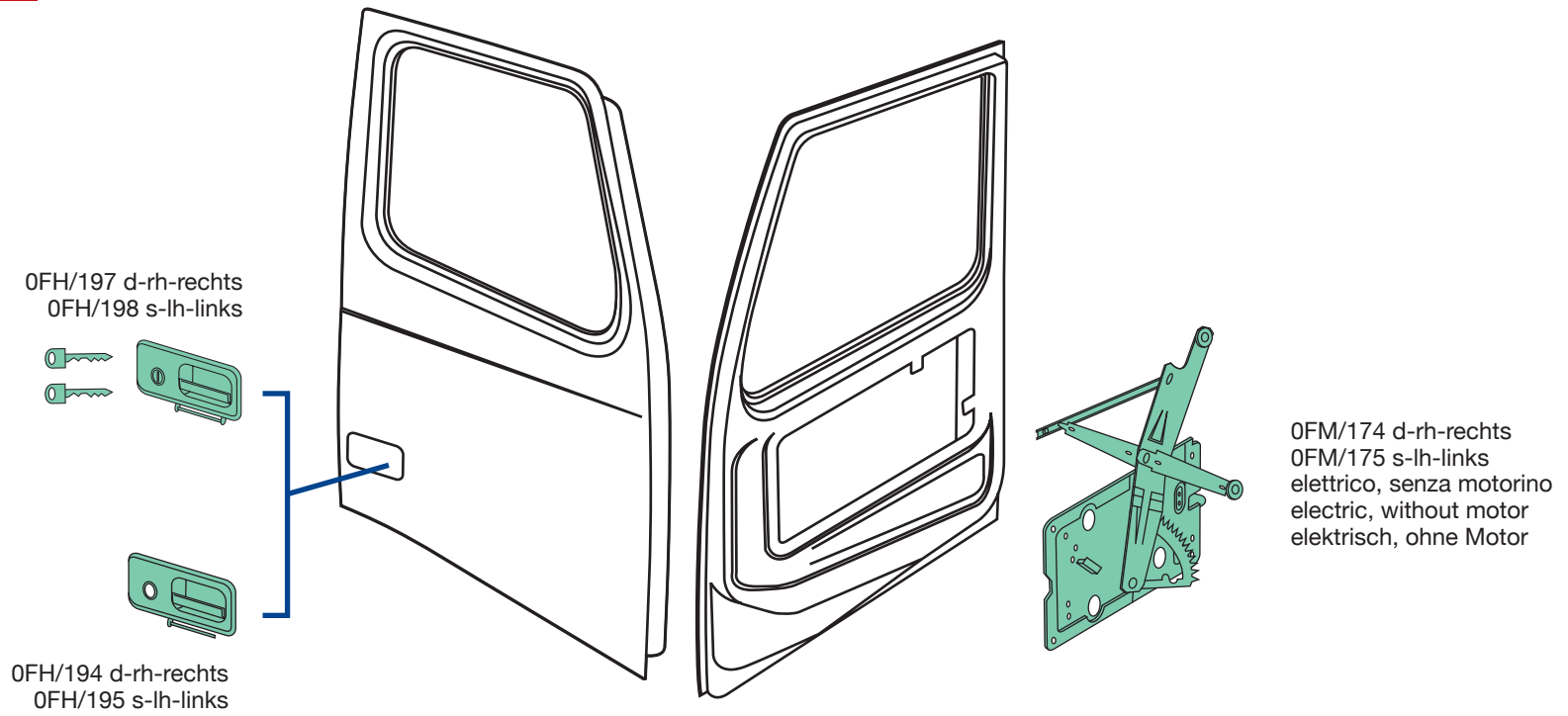

0FH/194
O.E.M. 20398467
0FH/195
O.E.M. 20398466

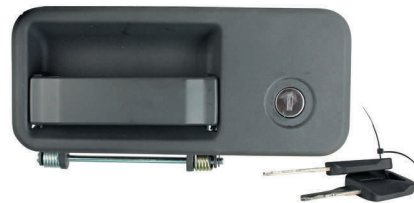

0FH/197
O.E.M. -
0FH/198
O.E.M. -



0FM/174
O.E.M. -
0FM/175
O.E.M. -

FM Euro 6

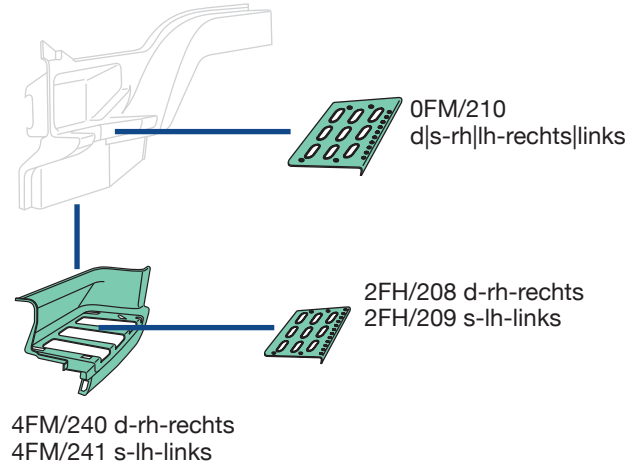

4FM/240
O.E.M. 21520119
4FM/241
O.E.M. 21520015



0FM/210
O.E.M. 1063726



2FH/208
O.E.M. 20360789
2FH/209
O.E.M. 20360788

applicabile a | suitable to | verwendbar für:

FM Euro 6

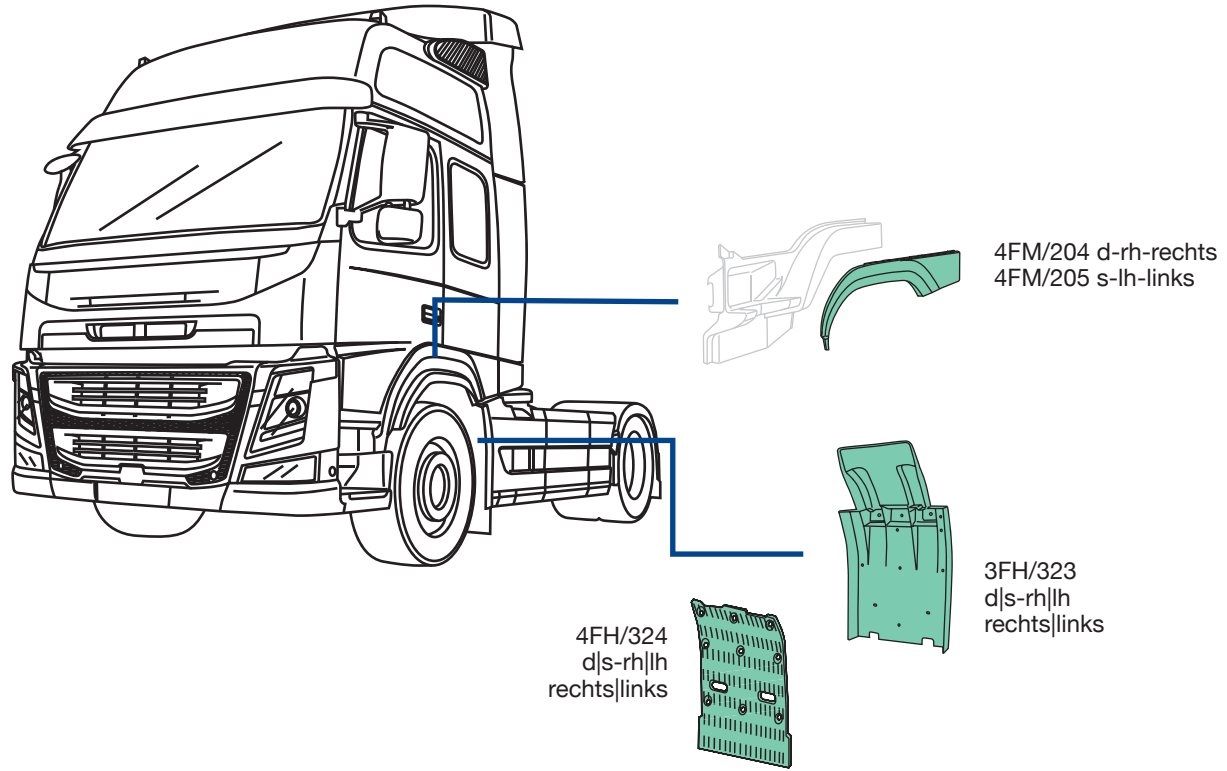

4FM/204 d-rh-rechts
4FM/205 s-lh-links

3FH/323
d|s-rh|lh
rechts|links

4FH/324
d|s-rh|lh
rechts|links



4FM/204
O.E.M. 82610343
4FM/205
O.E.M. 82610342

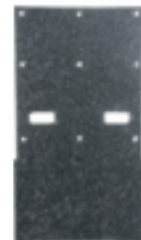

4FH/324
O.E.M. 84106936



3FH/323
O.E.M. 82637695

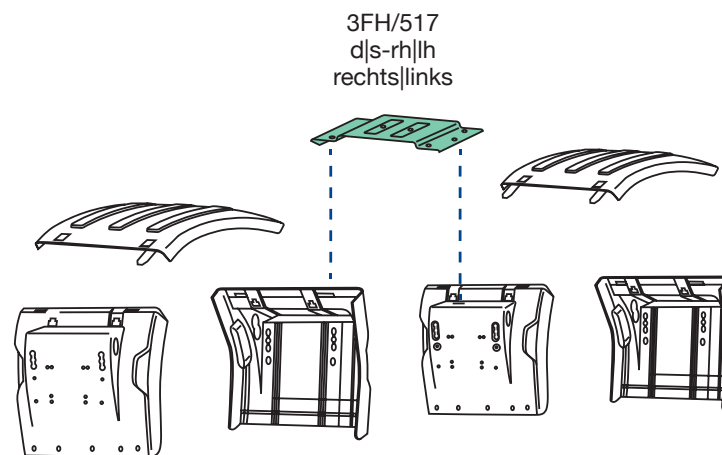

3FH/517
d/s-rh/lh
rechts/links



3FH/517
O.E.M. 21094406

applicabile a | suitable to | verwendbar für:

FM Euro 6

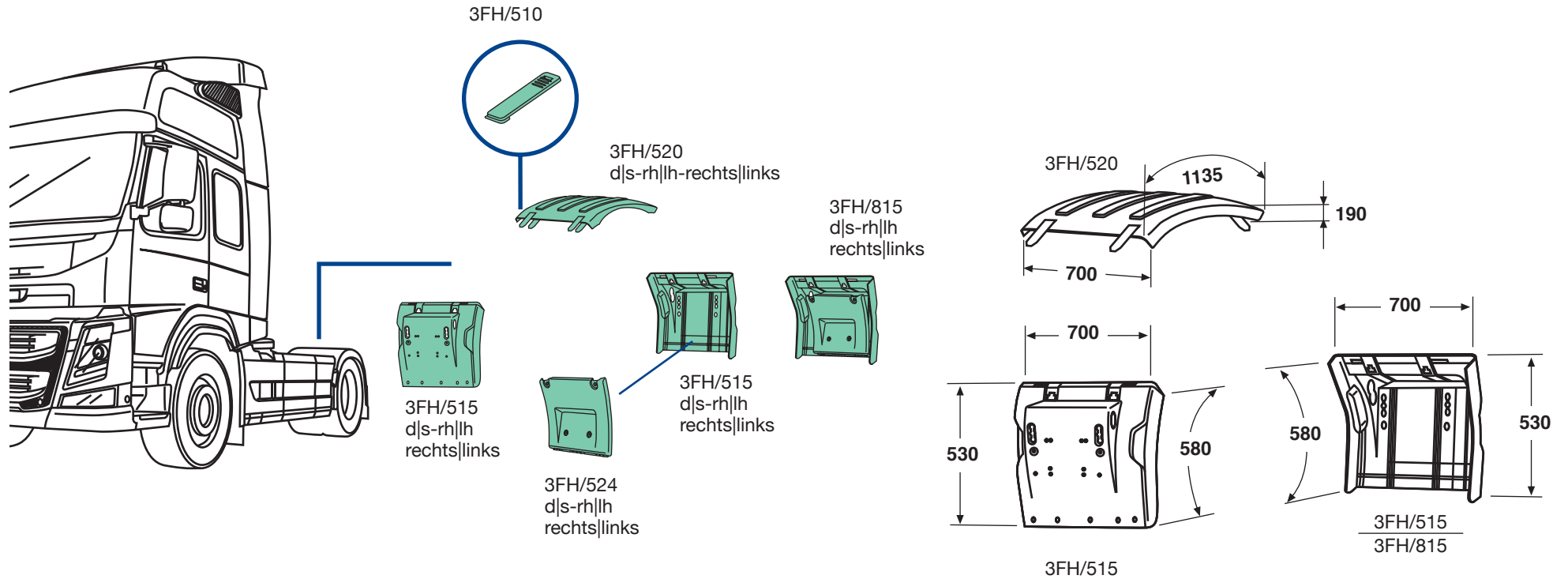

3FH/510
O.E.M. 21094457



3FH/524
O.E.M. 21094447

3FH/520
 O.E.M. 21094388
 d|s-rh|lh-rechts|links
 nero, semipiatta, con cinghietti
 black, semi-flat, with stretchers
 schwarz, halbfach, mit Spanngummi

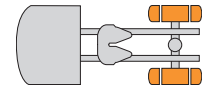

3FH/515
 O.E.M. 21094391
 d|s-rh|lh-rechts|links
 nero-black-schwarz



3FH/815
 O.E.M. -
 d|s-rh|lh-rechts|links
 nero-black-schwarz



3FH/815 O.E.M. -

**KIT
 Satz**



A	B	C	D	E	F	G	H	i
3FH/515 O.E.M. 21094391 1 pz.-pcs.-Stk.	3FH/524 O.E.M. 21094447 1 pz.-pcs.-Stk.	3FH/526 O.E.M. 21094456 + 21094454 2 pz.-pcs.-Stk.	- O.E.M. 21094449 1 pz.-pcs.-Stk.	- O.E.M. 21094453 2 pz.-pcs.-Stk.	- O.E.M. 21094451 6 pz.-pcs.-Stk.	- O.E.M. 992426 2 pz.-pcs.-Stk.	- O.E.M. 992423 6 pz.-pcs.-Stk.	- O.E.M. 60112154 2 pz.-pcs.-Stk.

applicabile a | suitable to | verwendbar für:

FM EURO 6

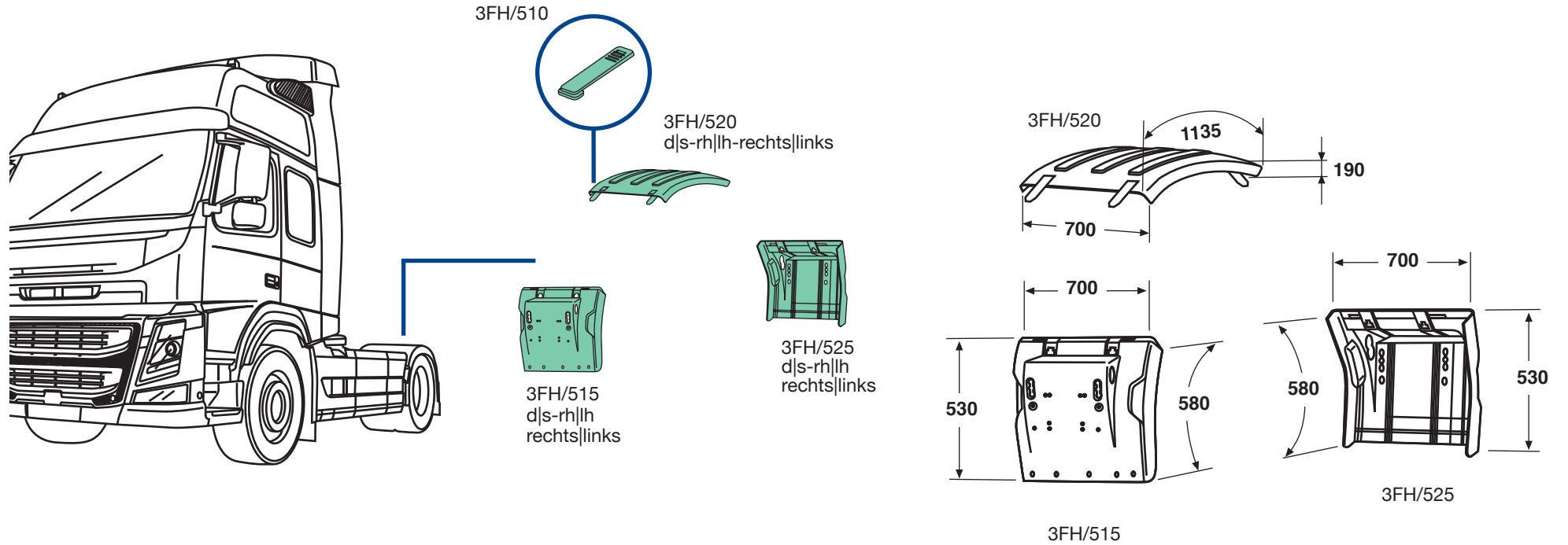

3FH/510
O.E.M. 21094457

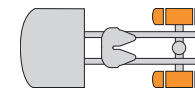

3FH/520
 O.E.M. 21094388
 d|s-rh|lh-rechts|links
 nero, semipiatta, con cinghietti
 black, semi-flat, with stretchers
 schwarz, halbflach, mit Spanngummi



3FH/525
 O.E.M. 21094394
 d|s-rh|lh-rechts|links
 nero, senza anti-spray
 black, without anti-spray
 schwarz, ohne Spritzschutz



3FH/515
 O.E.M. 21094391
 d|s-rh|lh-rechts|links
 nero-black-schwarz

applicabile a | suitable to | verwendbar für:

FM EURO 6

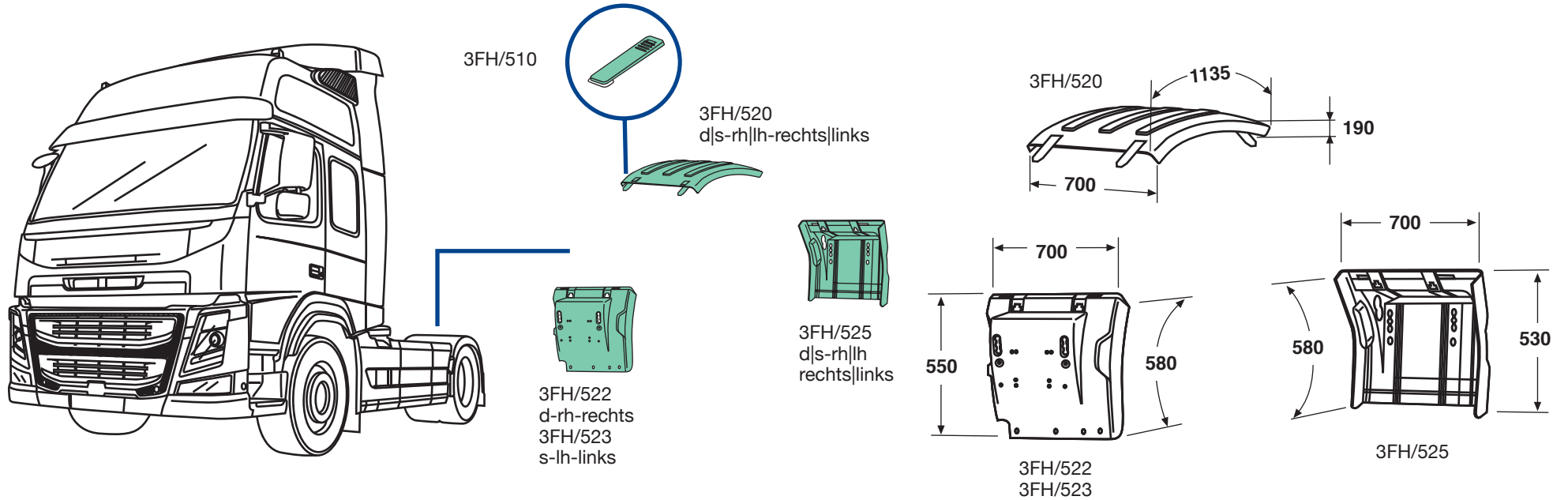

3FH/510
O.E.M. 21094457

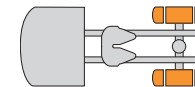

3FH/520
 O.E.M. 21094388
 d|s-rh|lh-rechts|links
 nero, semipiatta, con cinghietti
 black, semi-flat, with stretchers
 schwarz, halbfach, mit Spanngummi



3FH/525
 O.E.M. 21094394
 d|s-rh|lh-rechts|links
 nero, senza anti-spray
 black, without anti-spray
 schwarz, ohne Spritzschutz



3FH/520



3FH/525

3FH/522
 O.E.M. 21094392
 d-rh-rechts
 nero-black-schwarz

3FH/523
 O.E.M. 21094393
 s-lh-links
 nero-black-schwarz

applicabile a | suitable to | verwendbar für:

FM EURO 6

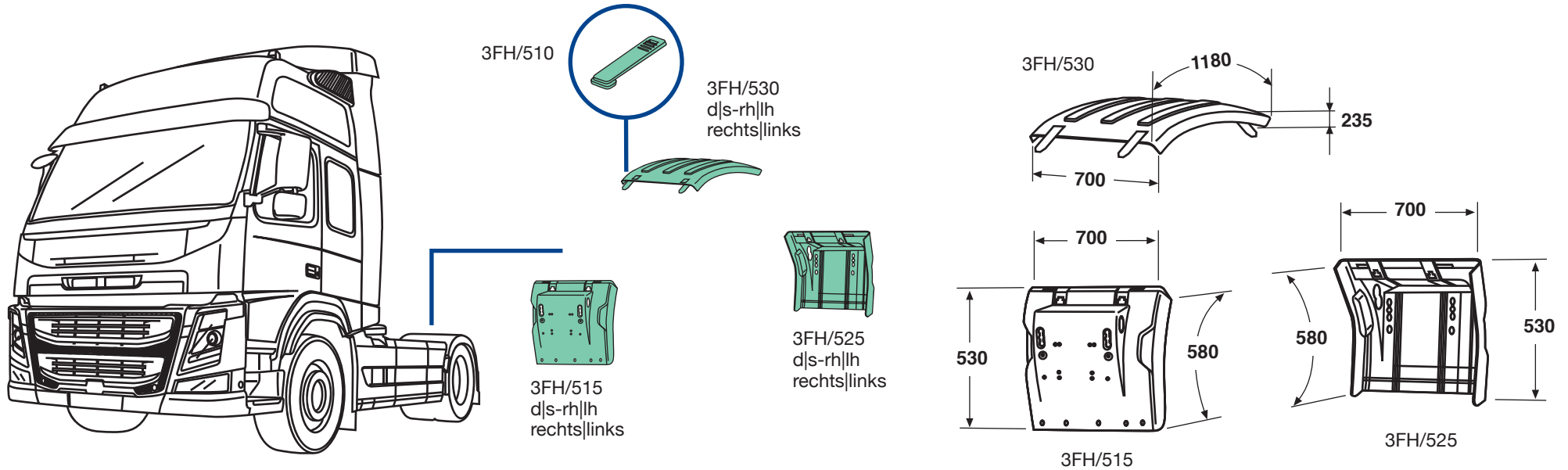

3FH/510
O.E.M. 21094457

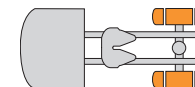

3FH/530
 O.E.M. 21094383
 d|s-rh|lh-rechts|links
 nero, circolare, senza cinghietti
 black, circular, without stretchers
 schwarz, kreisförmig, ohne Spanngummi



3FH/525
 O.E.M. 21094394
 d|s-rh|lh-rechts|links
 nero, senza anti-spray
 black, without anti-spray
 schwarz, ohne Spritzschutz



3FH/515
 O.E.M. 21094391
 d|s-rh|lh-rechts|links
 nero-black-schwarz

applicabile a | suitable to | verwendbar für:

FM EURO 6

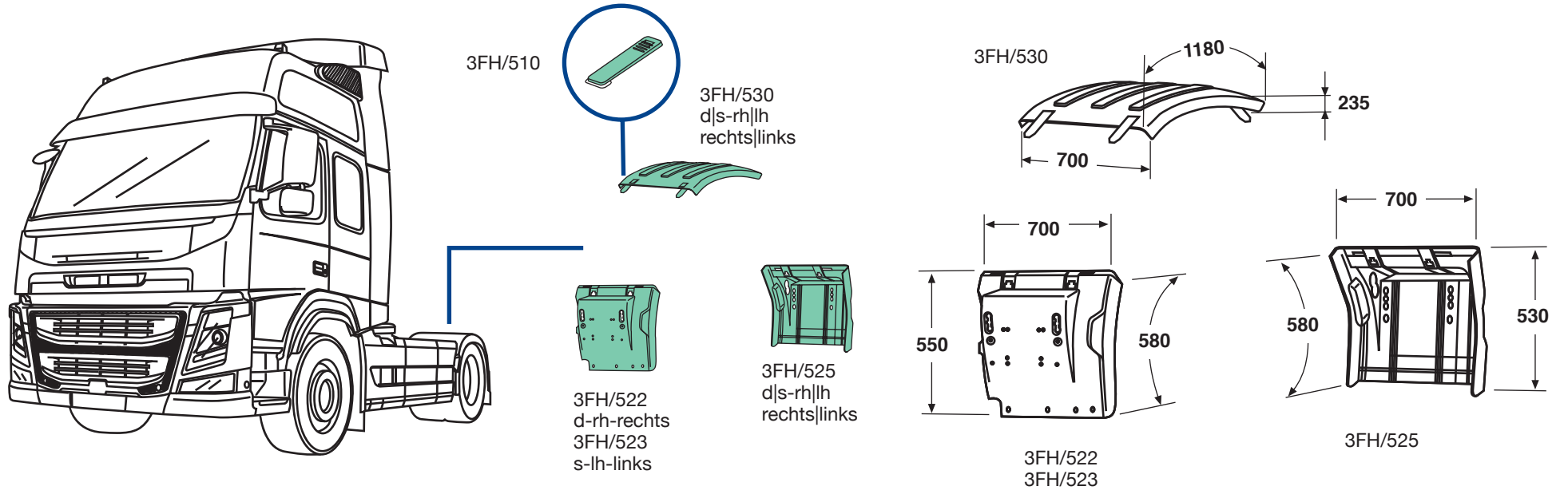

3FH/510
O.E.M. 21094457

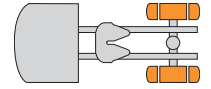

3FH/530
 O.E.M. 21094383
 d|s-rh|lh-rechts|links
 nero, circolare, senza cinghietti
 black, circular, without stretchers
 schwarz, kreisförmig, ohne Spanngummi



3FH/525
 O.E.M. 21094394
 d|s-rh|lh-rechts|links
 nero, senza anti-spray
 black, without anti-spray
 schwarz, ohne Spritzschutz



3FH/530



3FH/525

3FH/522
 O.E.M. 21094392
 d-rh-rechts
 nero-black-schwarz

3FH/523
 O.E.M. 21094393
 s-lh-links
 nero-black-schwarz

applicabile a | suitable to | verwendbar für:

FM EURO 6



3FH/510

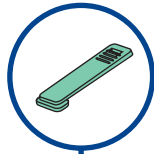

3FH/535
d|s-rh|lh
rechts|links

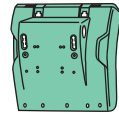

3FH/515
d|s-rh|lh
rechts|links

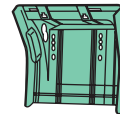

3FH/525
d|s-rh|lh
rechts|links

3FH/535

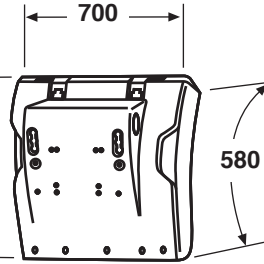
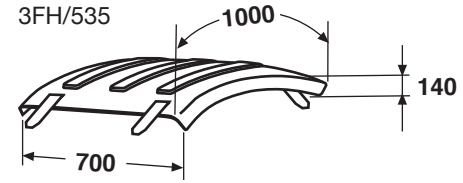

3FH/515

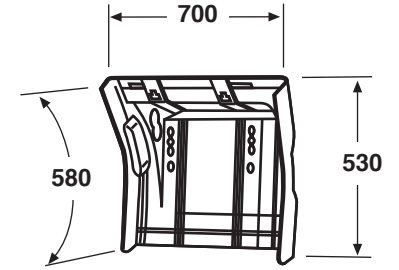

3FH/525



3FH/510
O.E.M. 21094457

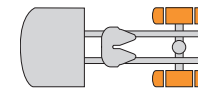

3FH/535
 O.E.M. 21094389
 d|s-rh||h-rechts|links
 nero, piatta, con cinghietti
 black, flat, with stretchers
 schwarz, flach, mit Spanngummi



3FH/525
 O.E.M. 21094394
 d|s-rh||h-rechts|links
 nero, senza anti-spray
 black, without anti-spray
 schwarz, ohne Spritzschutz



3FH/515
 O.E.M. 21094391
 d|s-rh||h-rechts|links
 nero-black-schwarz

applicabile a | suitable to | verwendbar für:

FM EURO 6



3FH/510

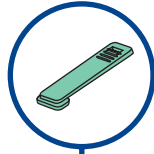

3FH/535
d|s-rh|lh
rechts|links

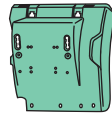

3FH/522
d-rh-rechts
3FH/523
s-lh-links

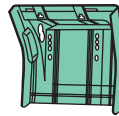

3FH/525
d|s-rh|lh
rechts|links

3FH/535

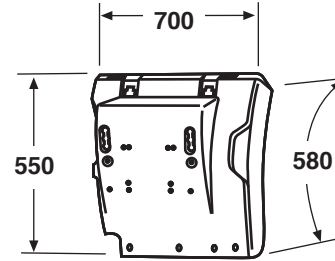
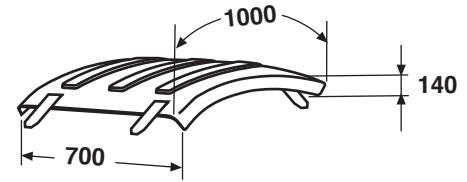

3FH/522
3FH/523

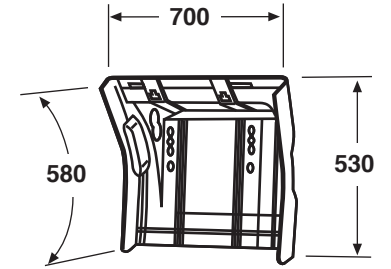

3FH/525



3FH/510
O.E.M. 21094457

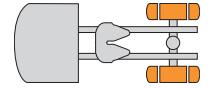

3FH/535
O.E.M. 21094389
d|s-rh|lh-rechts|links
nero, piatta, con cinghetti
black, flat, with stretchers
schwarz, flach, mit Spanngummi



3FH/522
O.E.M. 21094392
d-rh-rechts
nero-black-schwarz

3FH/525
O.E.M. 21094394
d|s-rh|lh-rechts|links
nero, senza anti-spray
black, without anti-spray
schwarz, ohne Spritzschutz



3FH/535



3FH/525

3FH/523
O.E.M. 21094393
s-lh-links
nero-black-schwarz

FM Euro 6

adattabile a: - suitable to: - passend für:

(*) 3FH/515

(°) 3FH/522-3FH/523

() 3FH/315-3FH/525**

3FH/527(*)

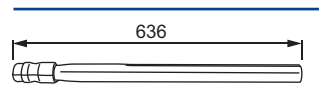

3FH/528(°)

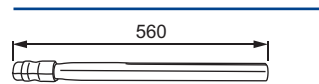

3FH/532(**)

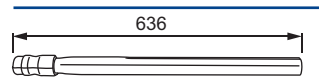

3FH/527(*)
d|s-rh|lh-rechts|links
3FH/528(°)
d|s-rh|lh-rechts|links
3FH/532(**)
d|s-rh|lh-rechts|links



2FH/528
d|s-rh|lh
rechts|links



2FH/526
d|s-rh|lh
rechts|links

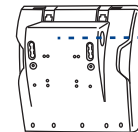

3FH/526
d|s-rh|lh
rechts|links

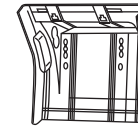

3FH/528
d|s-rh|lh
rechts|links



3FH/526
d|s-rh|lh
rechts|links



2FH/526
O.E.M. 21213202



2FH/528
O.E.M. 21090272



3FH/526
O.E.M. 21094456 +
21094454



3FH/527
O.E.M. 22192010
3FH/528
O.E.M. 22192007



3FH/532
O.E.M. 22192015

RRT/632 d-rh-rechts | RRT/631 s-lh-links



AMP 7 PIN

LATERALE
LATERAL
SEITLICH

RRT/630 d-rh-rechts



AMP 7 PIN

LATERALE
LATERAL
SEITLICH

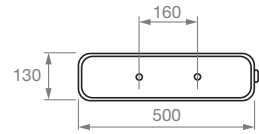

RRT/645 d-s|rh-lh|rechts-links

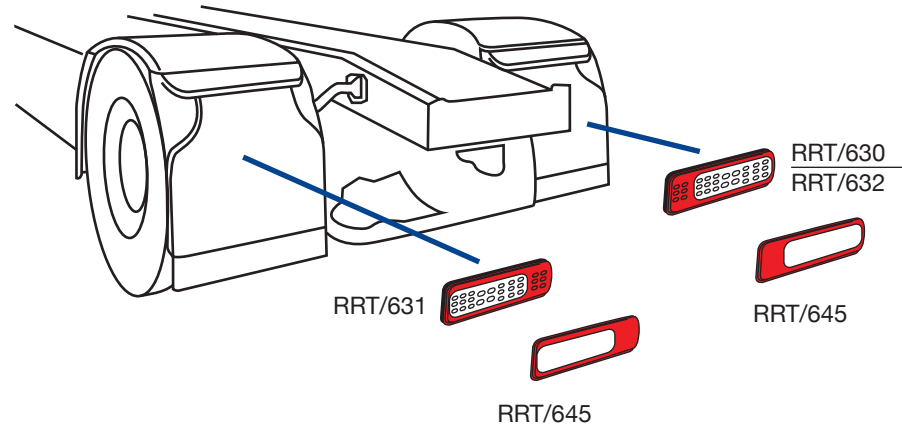
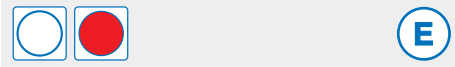

RRT/630
O.E.M. 23354973



RRT/632
O.E.M. 23354974
RRT/631
O.E.M. 23354972



RRT/645
O.E.M. 82849905

applicabile a | suitable to | verwendbar für:

FM Euro 6

RRT/634 (°) d-rh-rechts | RRT/635 (°) s-lh-links

		(*) CON CICALINO RETROMARCIA WITH BACK-UP ALARM AKUSTISCHE WARNVORRICHTUNG		(*) CON LUCE TARGA WITH NUMBER PLATE LAMP KENNZEICHENLEUCHTE		

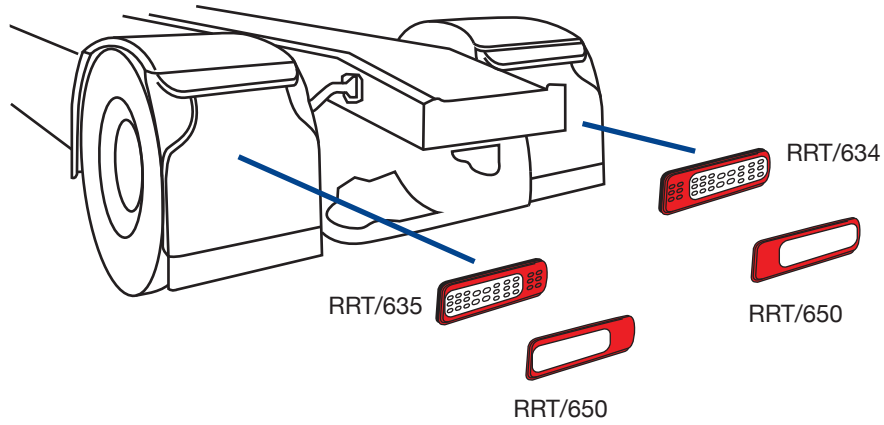
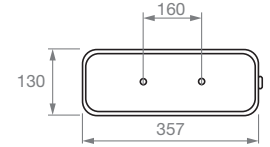

RRT/650 d-s|rh-lh|rechts-links

--	--	--



RRT/634
O.E.M. 23522308
RRT/635
O.E.M. 23522307



RRT/650
O.E.M. 84122332

0FH/675

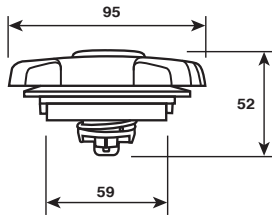

XF0/670

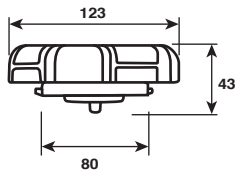

0FH/675

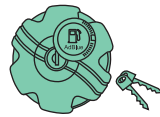

XF0/670

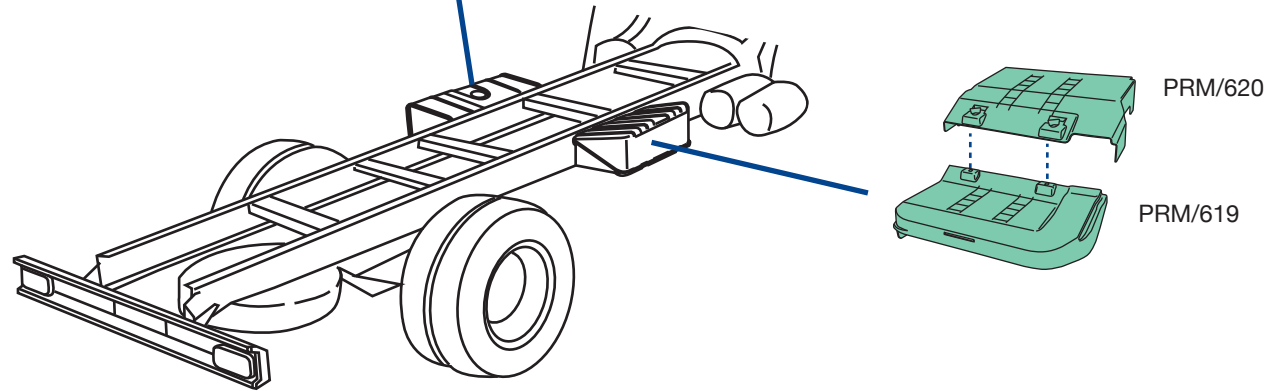
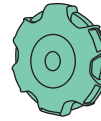

PRM/620

PRM/619



0FH/675
O.E.M. 21281403



XF0/670
O.E.M. -



PRM/619
O.E.M. 23417998



PRM/620
O.E.M. 23417997

applicabile a | suitable to | verwendbar für:

FM Euro 6

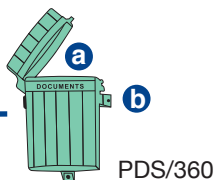
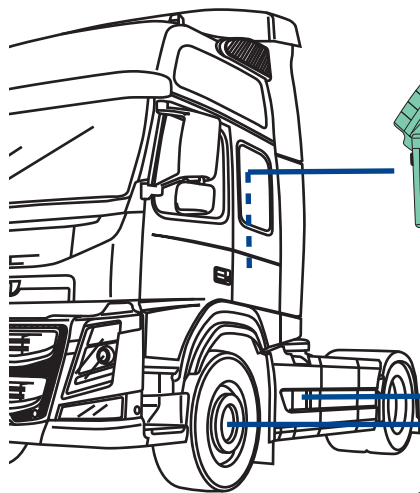

PDS/360



2FH/610
d|s-rh|lh-rechts|links



PRM/700
d|s-rh|lh-rechts|links
PRM/710
d|s-rh|lh-rechts|links

PDS/360

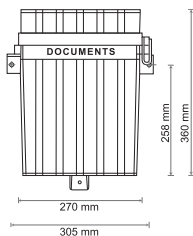

2FH/610 d|s-rh|lh-rechts|links

2002→

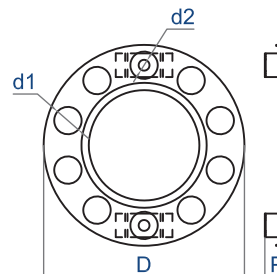
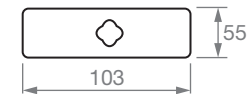

PRM/700 d|s-rh|lh-rechts+links

D ø 425 mm	P 40 mm
d1 nr. 10	d1 ø 58 mm
d2 nr. 2	d2 ø 24 mm
Ventilata	no-nein
Ventilated-Belüftet	
Colore	silver-silver-Silber
Colours-Farbe	
Materiale-Material	acciaio inox-stainless steel Edelstahl
Kg	1,700

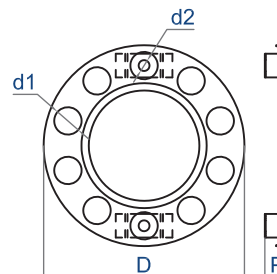

PRM/710 d|s-rh|lh-rechts+links

D ø 425 mm	P 40 mm
d1 nr. 10	d1 ø 58 mm
d2 nr. 2	d2 ø 24 mm
Ventilata	no-nein
Ventilated-Belüftet	
Colore	cromato-chrome-verchromt
Colours-Farbe	
Materiale-Material	acciaio inox-stainless steel Edelstahl
Kg	1,700

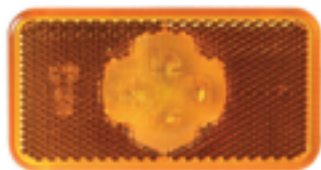

2FH/610
O.E.M. 20789440



PDS/360
O.E.M. -



PRM/700
O.E.M. 22709903



PRM/710
O.E.M. -



applicabile a | suitable to | verwendbar für

79

2FM

FM7-FM10-FM12 (2001 → 2005)

SECONDA SERIE | SECOND SERIES | ZWEITE SERIE

gallery

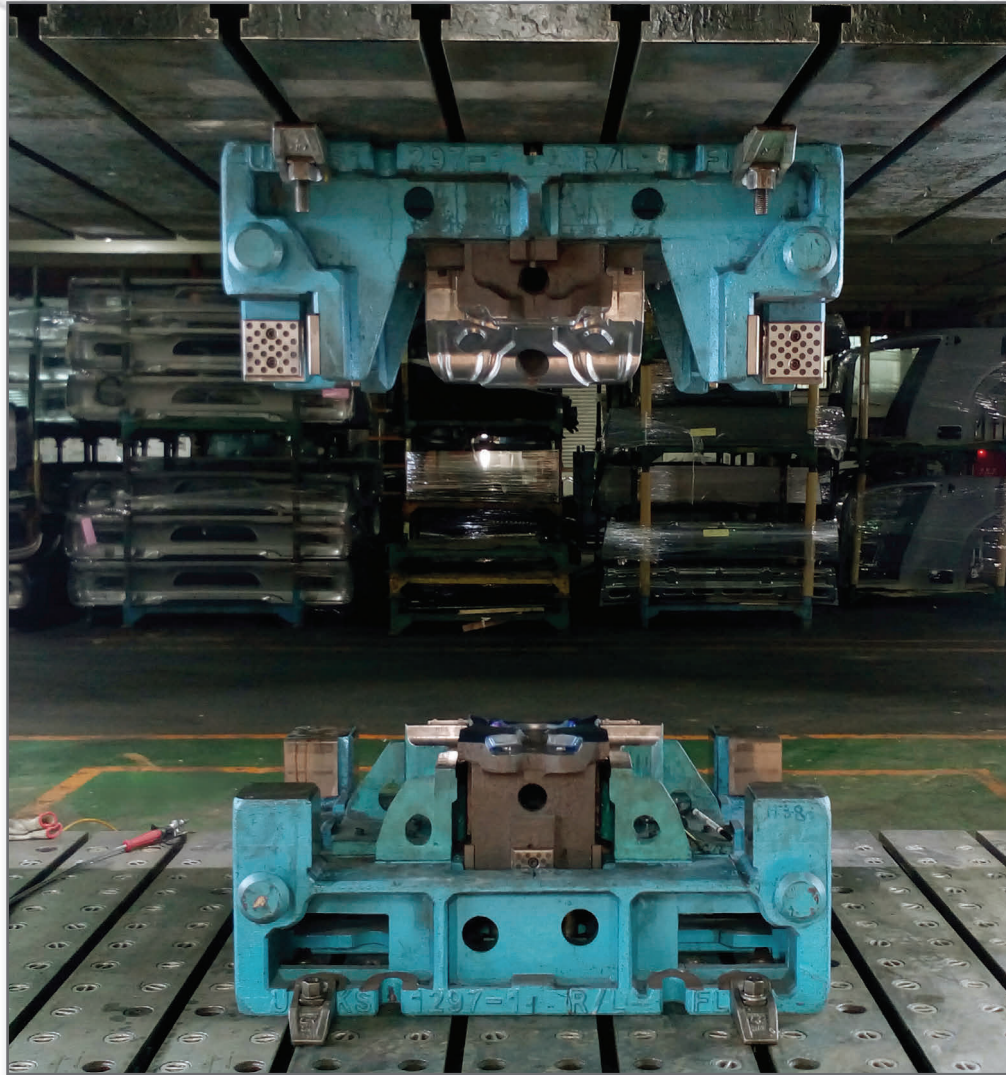

(*) Cava-Cantiere
Yard & Quarry
Baustellenfahrzeug

FM7-FM10-FM12 SECONDA SERIE | SECOND SERIES | ZWEITE SERIE

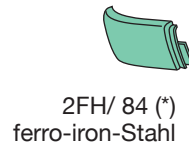
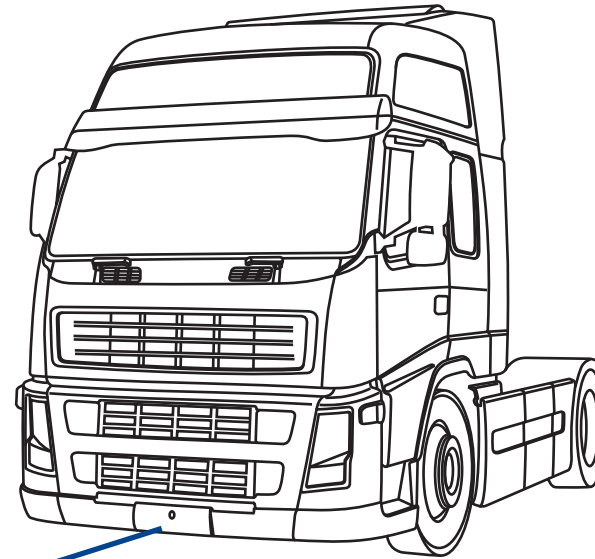

2FH/ 84 (*)
ferro-iron-Stahl



2FH/ 80 (*)
ferro-iron-Stahl



2FH/ 85 (*)
ferro-iron-Stahl



2FH/236 d-rh-rechts
2FH/237 s-lh-links



2FH/ 80
O.E.M. 21828914



2FH/ 84
O.E.M. 21829052
2FH/ 85
O.E.M. 21829051



2FH/236
O.E.M. 20453677
2FH/237
O.E.M. 20453676

applicabile a | suitable to | verwendbar für:

FM7-FM10-FM12 SECONDA SERIE | SECOND SERIES | ZWEITE SERIE

(*) grezzo
unprocessed
roh

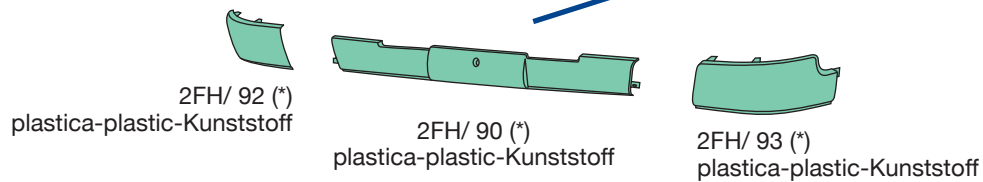

2FH/ 90
O.E.M. 21359080



2FH/ 92
O.E.M. 21359090
2FH/ 93
O.E.M. 21359082

(*) verniciato grigio scuro
dark grey painted
dunkel grau strukturlackiert

applicabile a | suitable to | verwendbar für:

FM7-FM10-FM12 SECONDA SERIE | SECOND SERIES | ZWEITE SERIE

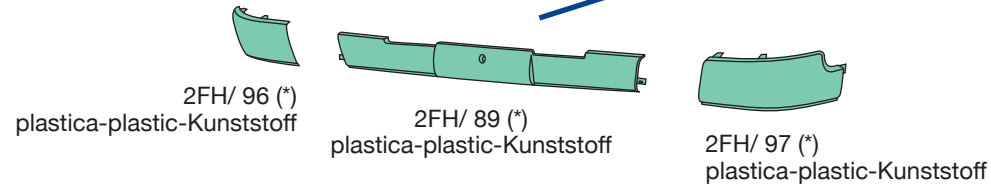
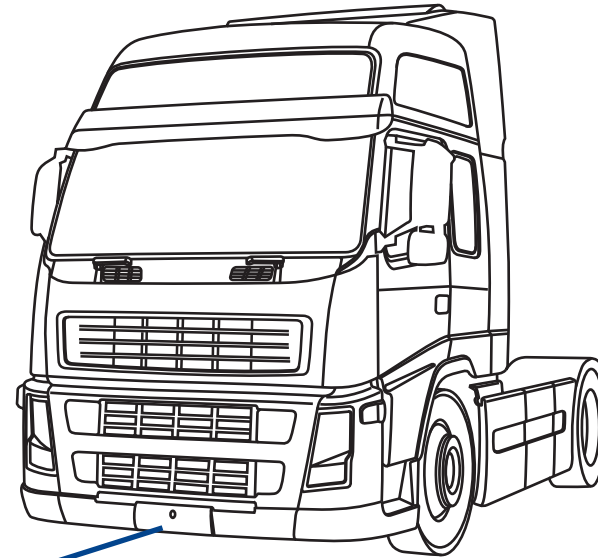

2FH/ 89
O.E.M. 20529740



2FH/ 96
O.E.M. 20529742
2FH/ 97
O.E.M. 20529741

applicabile a | suitable to | verwendbar für:

FM7-FM10-FM12 SECONDA SERIE | SECOND SERIES | ZWEITE SERIE

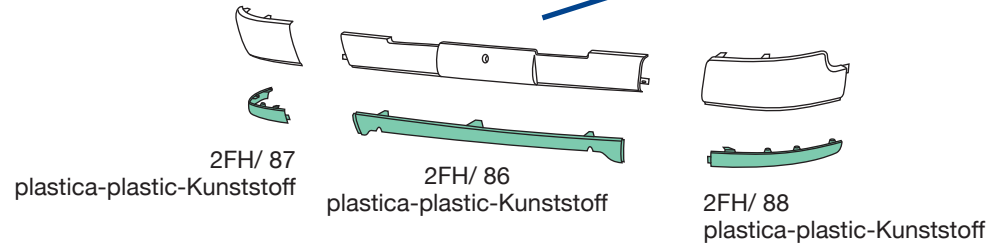
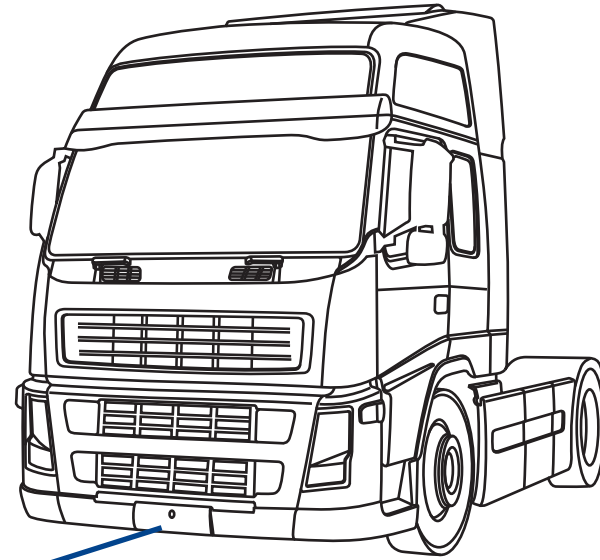

2FH/ 86
O.E.M. 21430599



2FH/ 87
O.E.M. 21430672
2FH/ 88
O.E.M. 21430600

FM7-FM10-FM12 SECONDA SERIE | SECOND SERIES | ZWEITE SERIE

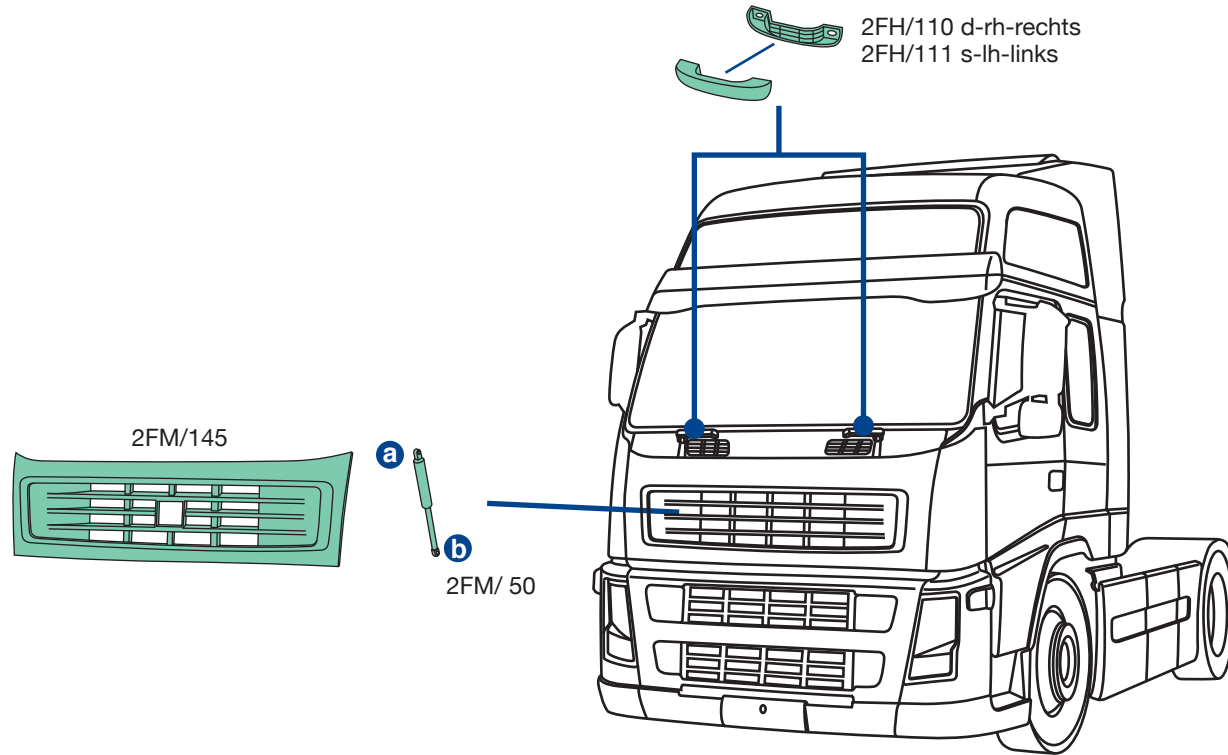

2FM/ 50
O.E.M. 20379349



2FM/145
O.E.M. 3175376



2FH/110
O.E.M. 3175367+3175366
2FH/111
O.E.M. 20383543+3175366

applicabile a | suitable to | verwendbar für:

FM7-FM10-FM12 SECONDA SERIE | SECOND SERIES | ZWEITE SERIE

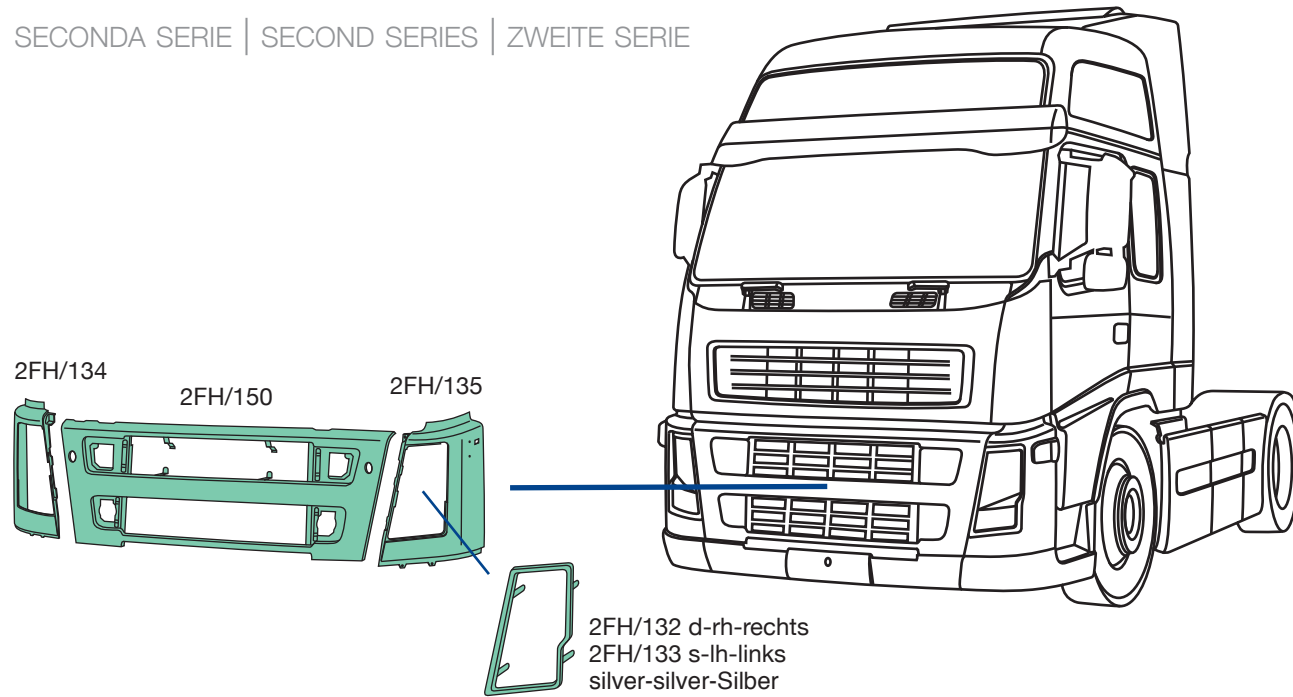

2FH/132
O.E.M. 20452848
2FH/133
O.E.M. 20452847



2FH/134
O.E.M. 21469924
2FH/135
O.E.M. 21469918



2FH/150
O.E.M. 21430596

FM7-FM10-FM12 SECONDA SERIE | SECOND SERIES | ZWEITE SERIE

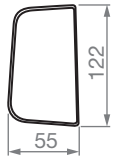

2FH/ 94 d-rh-rechts
2FH/ 95 s-lh-links

2FH/ 98 d-rh-rechts
2FH/ 99 s-lh-links

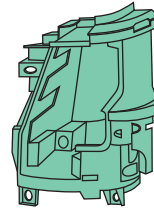
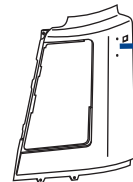

2FH/136 d-rh-rechts
2FH/137 s-lh-links

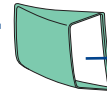

a



2FH/606 d-rh-rechts
2FH/607 s-lh-links



2FH/ 94
O.E.M. 21359260
2FH/ 95
O.E.M. 21359257



2FH/ 98
O.E.M. 20917958
2FH/ 99
O.E.M. 20917957



2FH/136
O.E.M. 21469979
2FH/137
O.E.M. 21430598



2FH/606
O.E.M. 20826213
2FH/607
O.E.M. 20826211



applicabile a | suitable to | verwendbar für:

FM7-FM10-FM12 SECONDA SERIE | SECOND SERIES | ZWEITE SERIE

2FH/602 d-rh-rechts | 2FH/603 s-lh-links 2002→2007



2FH/604 d-rh-rechts | 2FH/605 s-lh-links 2002→2007



2FH/602 d-rh-rechts
2FH/603 s-lh-links
2FH/604 d-rh-rechts
2FH/605 s-lh-links

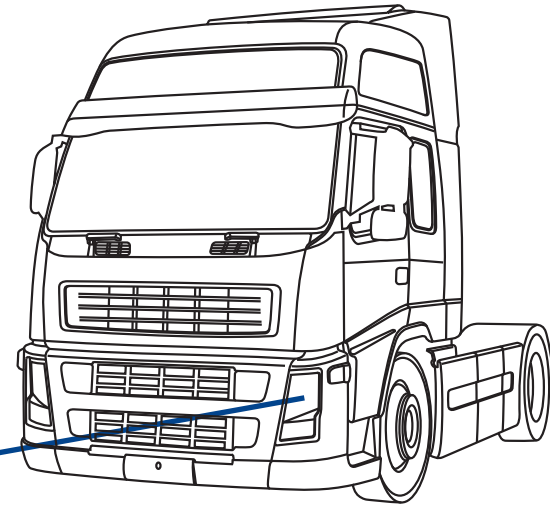
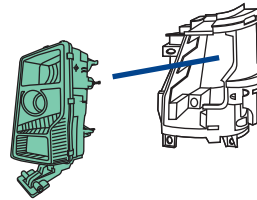

12 pins



2FH/602
O.E.M. 21001649
2FH/603
O.E.M. 21001645



9 pins



2FH/604
O.E.M. 21001668
2FH/605
O.E.M. 21001663

(*) >2007 singole-singles-Einzelteil
2007> 2FH/152 + 2FH/153 (in coppia-a pair of-Paar)

FM7-FM10-FM12 SECONDA SERIE | SECOND SERIES | ZWEITE SERIE

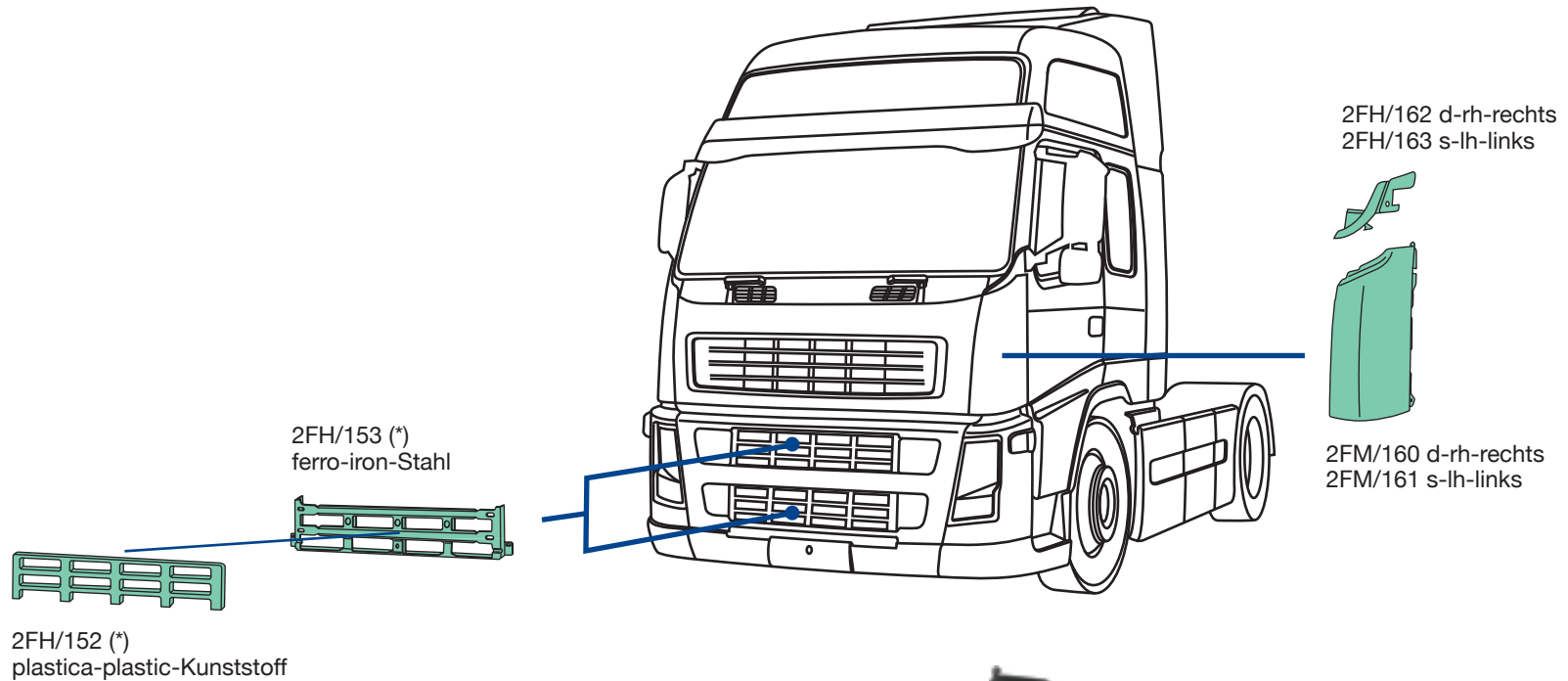

2FH/152
O.E.M. 20409818



2FH/153
O.E.M. 20456963



2FM/160
O.E.M. 20379172
2FM/161
O.E.M. 20379171



2FH/162
O.E.M. 20529672
2FH/163
O.E.M. 20529668

applicabile a | suitable to | verwendbar für:

FM7-FM10-FM12 SECONDA SERIE | SECOND SERIES | ZWEITE SERIE

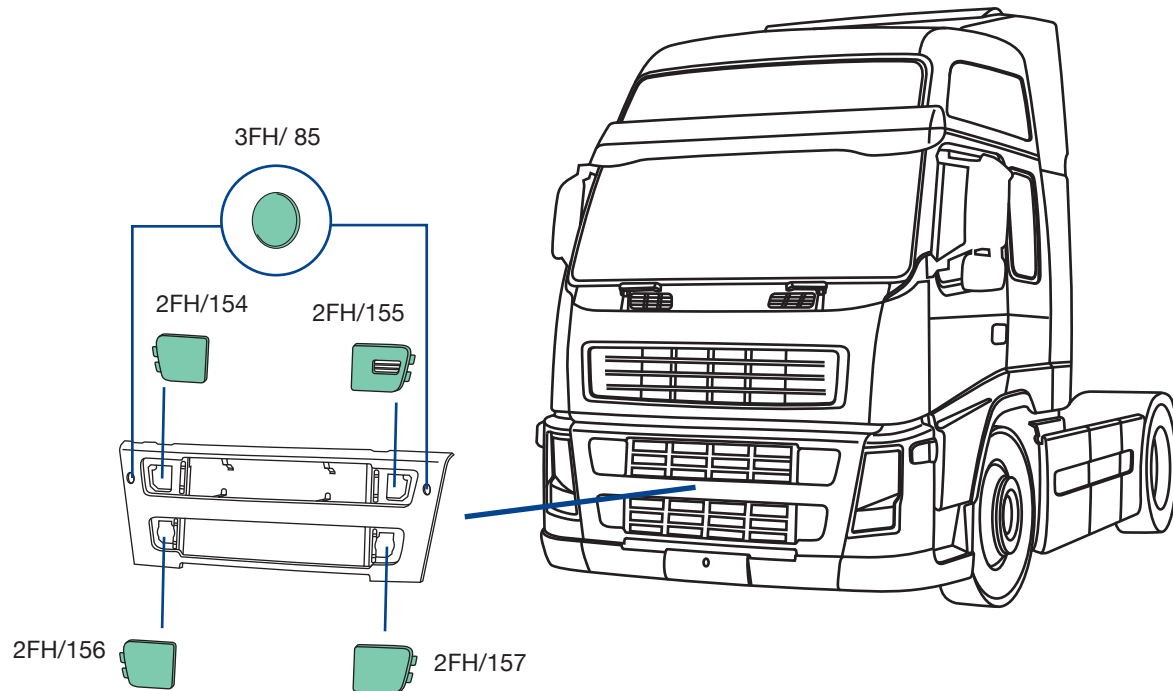

2FH/154
O.E.M. 20529706



2FH/155
O.E.M. 20529705



2FH/156
O.E.M. 20529708
2FH/157
O.E.M. 20529707



3FH/85
O.E.M. 21425186

2FH/400 20456709

materiale | material | material PMMA - Acrylglas

peso | weight | Gewicht 1,920 Kg

applicabilità | suitable to | für
VOLVO 2FH. FH II 2002→2008
VOLVO 2FM. FM II 2002→2008

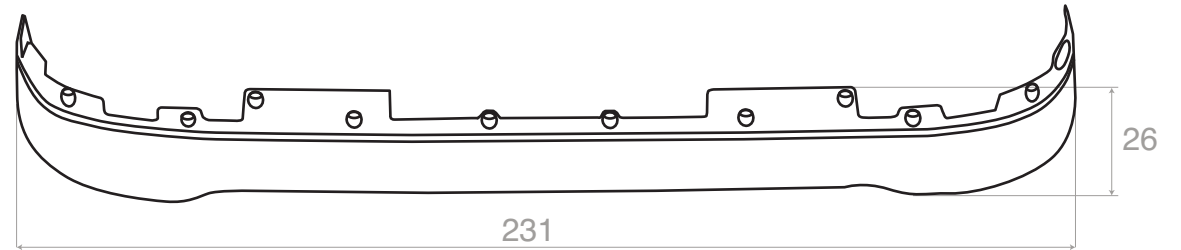

(cm)



2FH/410 20527443



2FH/480

20467422
20467412
20467414
20467424



applicabile a | suitable to | verwendbar für:



FM7-FM10-FM12 SECONDA SERIE | SECOND SERIES | ZWEITE SERIE

3FH/502



II

E4 024111

200x435 mm



IV

E4 024112

176x188 mm

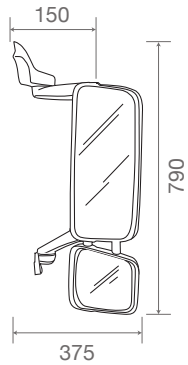

applicabilità:
applicable to:
Verwendbar für

VOLVO 2FH. FH II 2002→
VOLVO 2FM. FM II 2002→

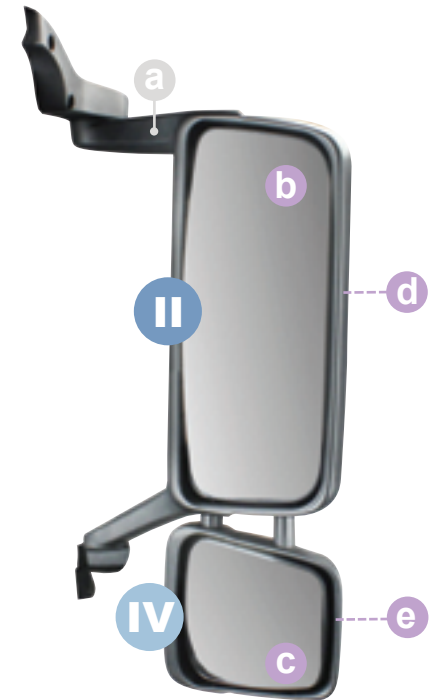

COVIND II
2FH/500
IV



249x231 mm

a

-

-

b

2FH/503

 21320404
(20589788)

 E4 024111
200x435 mm

II

c

2FH/504

 21320300
(20567685)
(20455995)

 E4 024112
176x188 mm

IV

d

2FH/502

 20746401
(20360810)

187x435 mm

II

e

2FH/508

20360811



250x200 mm

IV

applicabile a | suitable to | verwendbar für:



FM7-FM10-FM12 SECONDA SERIE | SECOND SERIES | ZWEITE SERIE

3FH/503



II (E4) 024111
200x435 mm



IV (E4) 024112
176x188 mm

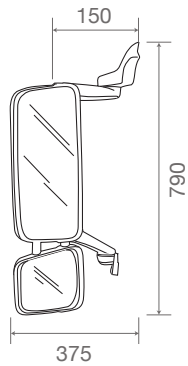

applicabilità:
applicable to:
Verwendbar für

VOLVO 2FH. FH II 2002→
VOLVO 2FM. FM II 2002→

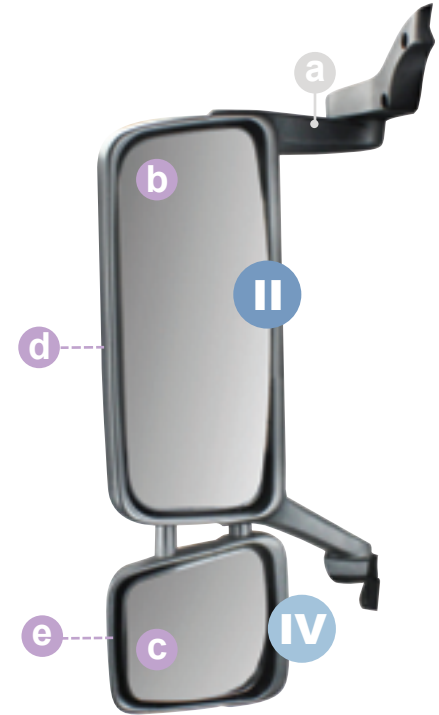

COVIND II
IV

2FH/501



250x235 mm

a

-

-

b

2FH/503

 21320404
(20589788)

(E4) 024111

200x435 mm

II

c

2FH/504

 21320300
(20567685)
(20455995)



(E4) 024112

176x188 mm

IV

d

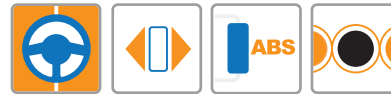
2FH/502

 20746401
(20360810)

187x435 mm

II

e

2FH/508

20360811



250x200 mm

IV

applicabile a | suitable to | verwendbar für:

FM7-FM10-FM12 SECONDA SERIE | SECOND SERIES | ZWEITE SERIE

2FH/506

20854644
(1096643)

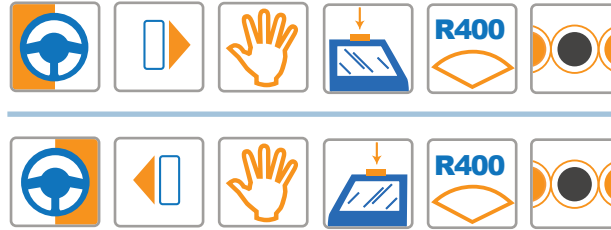

V E9 026322
275x165 mm

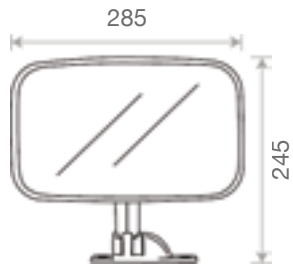

applicabilità:
applicable to:
Verwendbar für

VOLVO 0FH. FH I
VOLVO 2FH. FH II
VOLVO 0FM. FM I
VOLVO 2FM. FM II



FM7-FM10-FM12 SECONDA SERIE | SECOND SERIES | ZWEITE SERIE

3FH/514

20716956

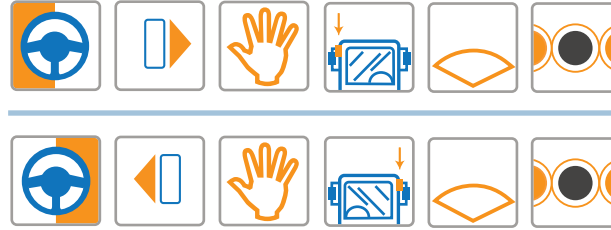

VI E9 026323
255x142 mm

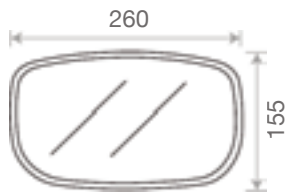

applicabilità:
applicable to:
Verwendbar für

VOLVO 3FH. FH III
VOLVO 2FM. FM II



applicabile a | suitable to | verwendbar für:

FM7-FM10-FM12 SECONDA SERIE | SECOND SERIES | ZWEITE SERIE

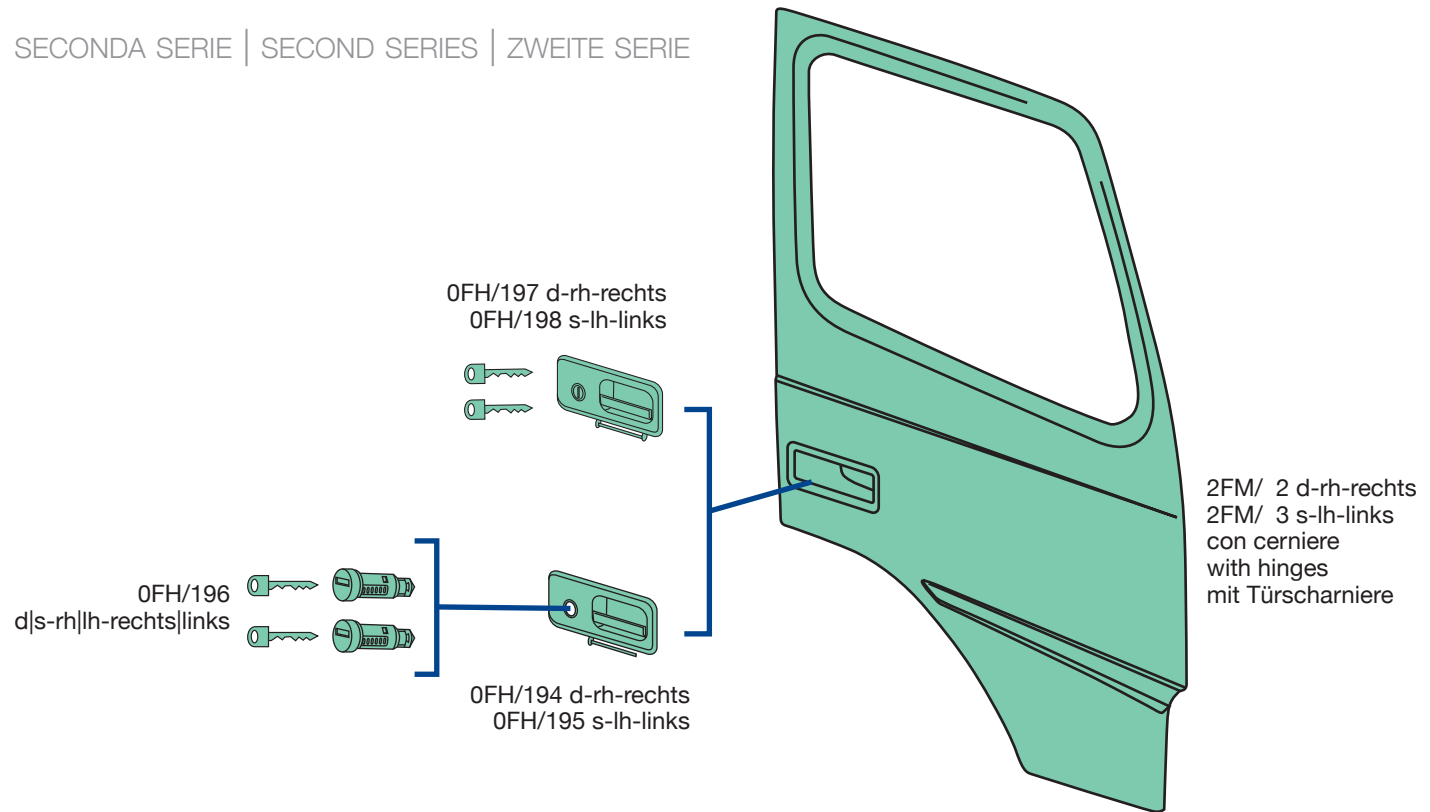

2FM/ 2
O.E.M. 20360850
2FM/ 3
O.E.M. 20360849



0FH/194
O.E.M. 20398467
0FH/195
O.E.M. 20398466



0FH/196
O.E.M. 3090484

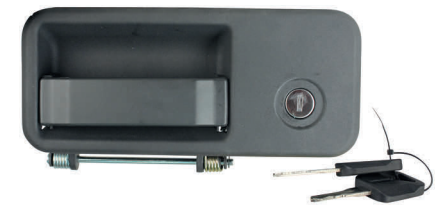

0FH/197
O.E.M. -
0FH/198
O.E.M. -

FM7-FM10-FM12 SECONDA SERIE | SECOND SERIES | ZWEITE SERIE

2FH/190
d-rh-rechts
2FH/191
s-lh-links

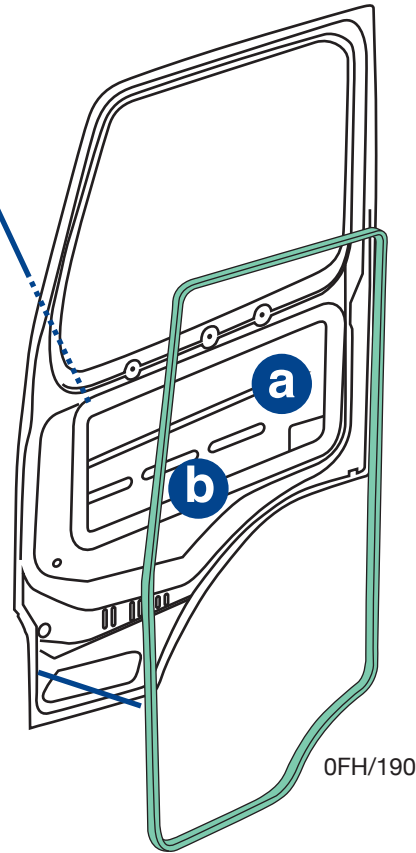
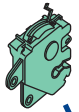

0FH/190

a

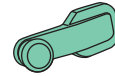

0FM/170
d|s-rh|lh
rechts|links

b

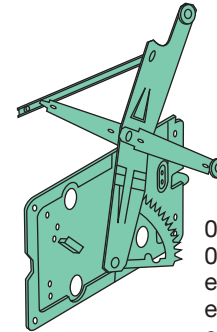

0FM/174 d-rh-rechts
0FM/175 s-lh-links
elettrico, senza motorino
electric, without motor
elektrisch, ohne Motor

0FH/190

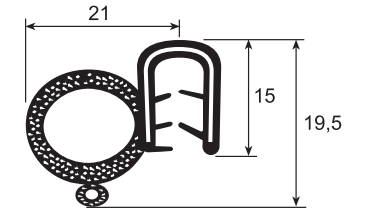

0FH/190
O.E.M. 3175029



0FM/170
O.E.M. 8140016



0FM/174
O.E.M. -
0FM/175
O.E.M. -



2FH/190
O.E.M. 20570722
2FH/191
O.E.M. 20570721

applicabile a | suitable to | verwendbar für:

FM7-FM10-FM12 | SECONDA SERIE | SECOND SERIES | ZWEITE SERIE

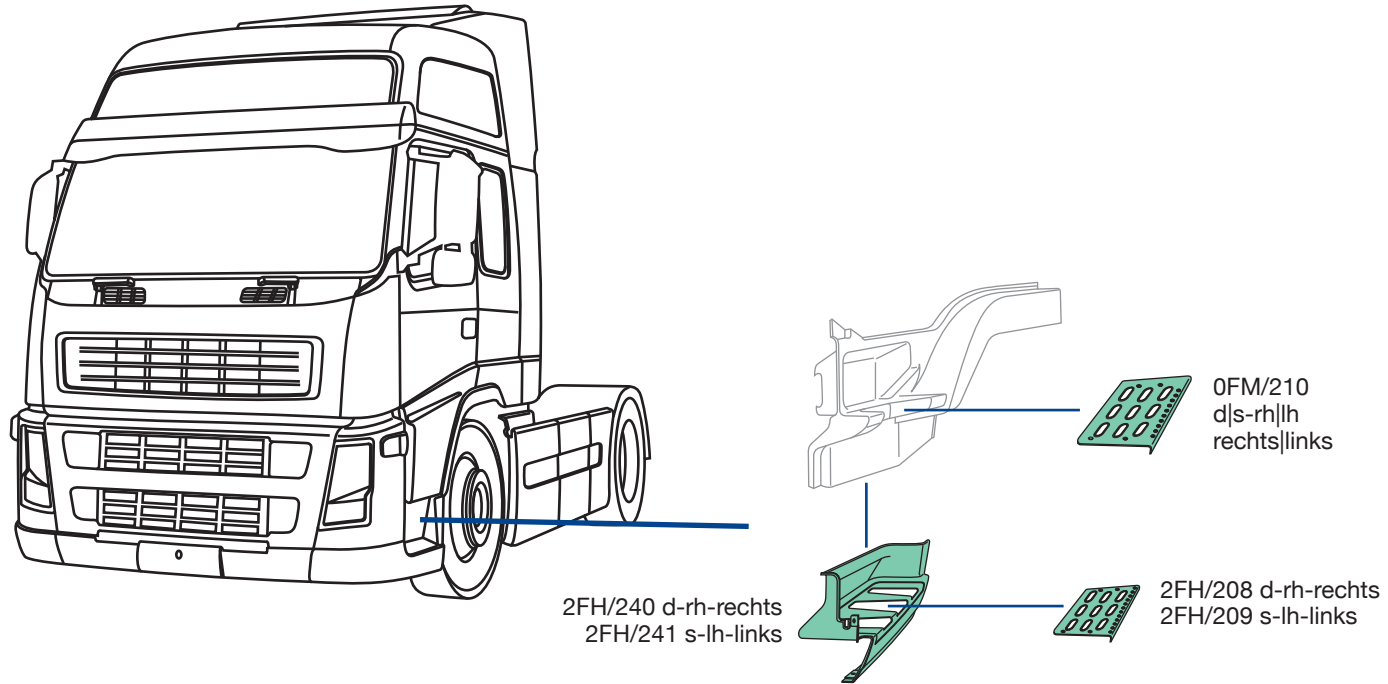

0FM/210
O.E.M. 1063726



2FH/208
O.E.M. 20360789
2FH/209
O.E.M. 20360788



2FH/240
O.E.M. 20529640
2FH/241
O.E.M. 20529638

FM7-FM10-FM12 SECONDA SERIE | SECOND SERIES | ZWEITE SERIE

2FH/610 d|s-rh|lh-rechts|links

2002→

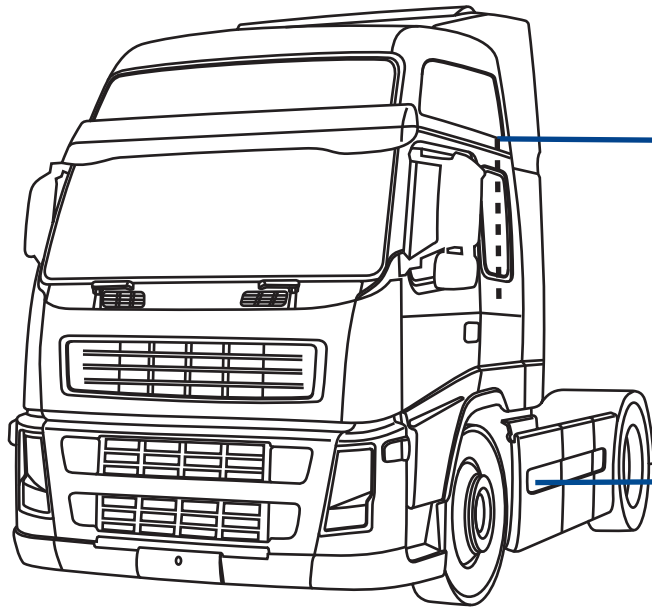

PDS/360

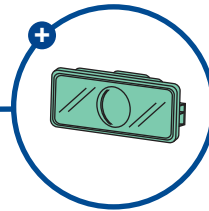

2FH/610
d|s-rh|lh-rechts|links

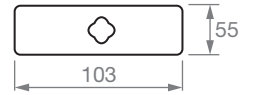

PDS/360

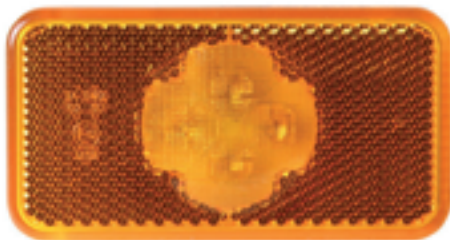
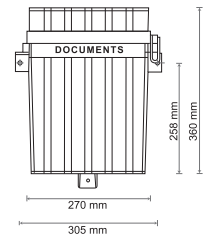

2FH/610
O.E.M. 20789440

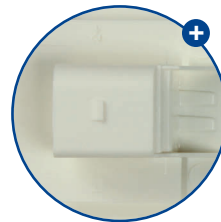

PDS/360
O.E.M. -



applicabile a | suitable to | verwendbar für:

FM7-FM10-FM12 SECONDA SERIE | SECOND SERIES | ZWEITE SERIE

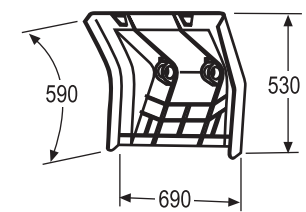
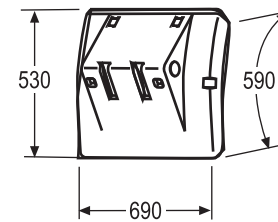
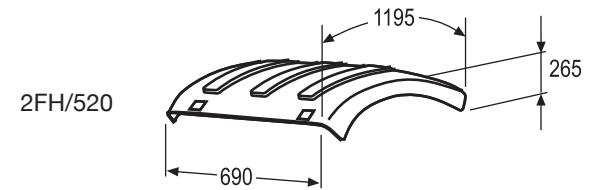
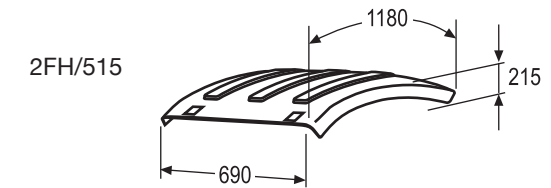
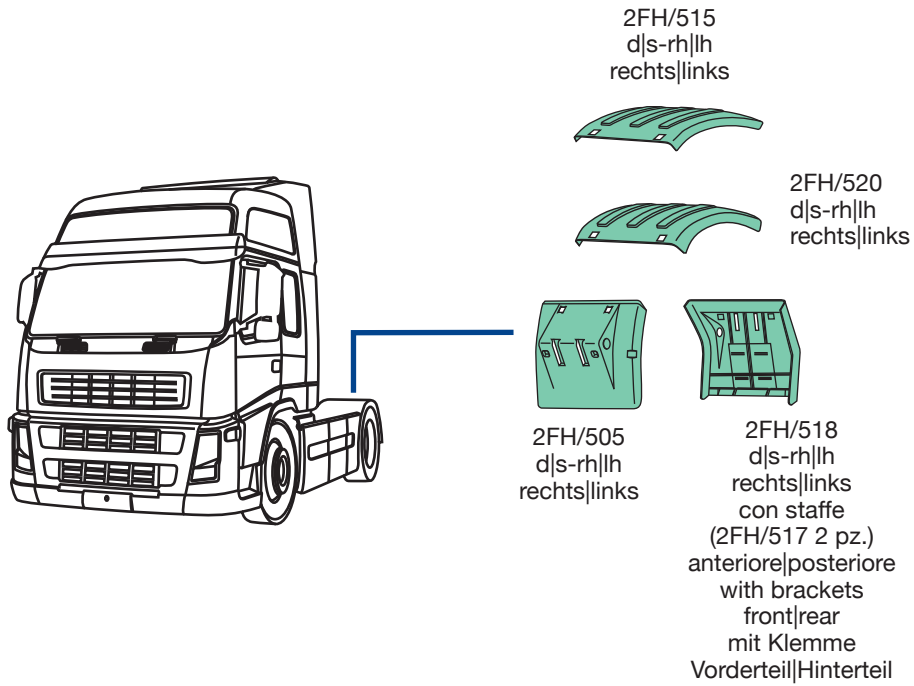

2FH/505

2FH/518

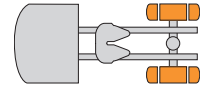

2FH/515
 O.E.M. 20936759
 d|s-rh|lh-rechts|links
 nero, semipiatta, senza cinghietti
 black, semi-flat, without stretchers
 schwarz, halbflach, ohne Spanngummi



2FH/518
 O.E.M. 20392599
 d|s-rh|lh-rechts|links
 nero, senza anti-spray, con staffe
 black, without anti-spray, with brackets
 schwarz, ohne Spritzschutz, mit Klemme



2FH/520
 O.E.M. 20936769
 d|s-rh|lh-rechts|links
 nero, circolare, senza cinghietti
 black, circular, without stretchers
 schwarz, kreisförmig, ohne Spanngummi



2FH/518

2FH/505
 O.E.M. 20392544
 d|s-rh|lh-rechts|links
 nero, senza staffe
 black, without brackets
 schwarz, ohne Klemme



2FH/505

applicabile a | suitable to | verwendbar für:

FM7-FM10-FM12 SECONDA SERIE | SECOND SERIES | ZWEITE SERIE

(*) Applicabile con il cinghietto 2FH/510
Applied with stretcher 2FH/510
bestückt mit 2FH/510

(°) Applicabile con il cinghietto PRM/515
Applied with stretcher PRM/515
bestückt mit PRM/515

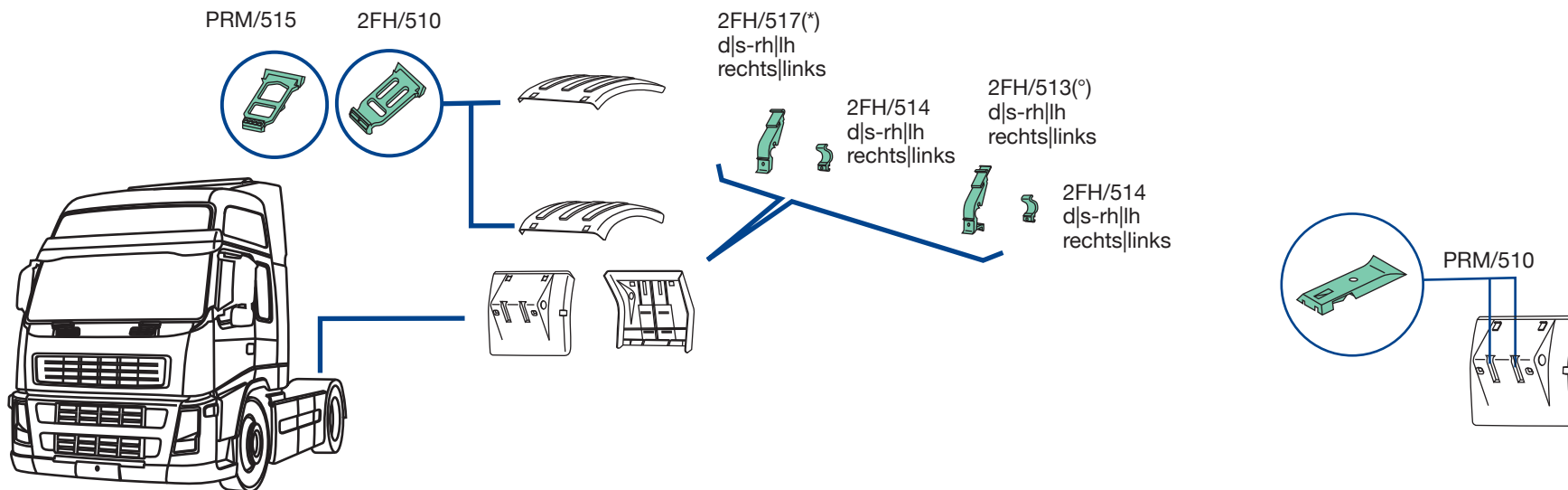

PRM/510
O.E.M. 20721840



PRM/515
O.E.M. 20498623



2FH/510
O.E.M. 1079981



2FH/513
O.E.M. 20583434



2FH/514
O.E.M. 20583440



2FH/517
O.E.M. 3987252

(*) adattabile a 2FH/505
 suitable to 2FH/505
 passend für 2FH/505

applicabile a | suitable to | verwendbar für:

FM7-FM10-FM12 SECONDA SERIE | SECOND SERIES | ZWEITE SERIE

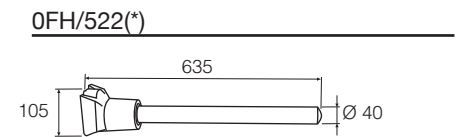
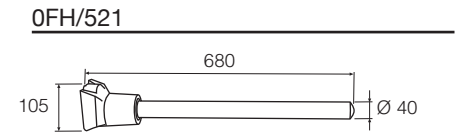
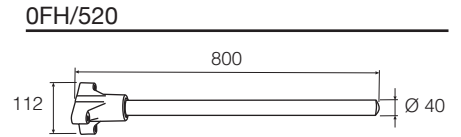
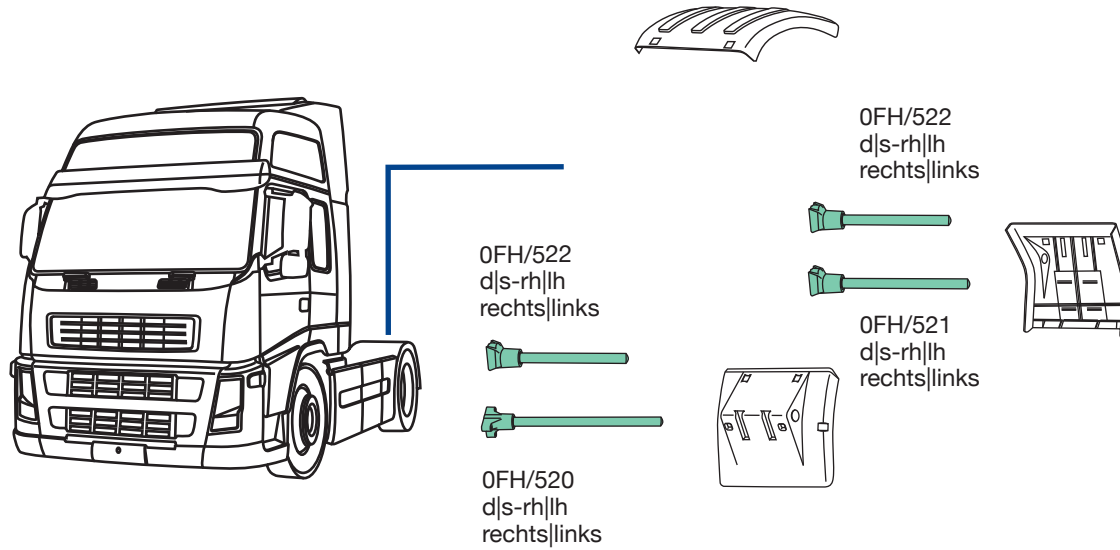

OFH/520
 O.E.M. 8154385



OFH/521
 O.E.M. 20466895



OFH/522
 O.E.M. 20466894

applicabile a | suitable to | verwendbar für:

FM7-FM10-FM12 SECONDA SERIE | SECOND SERIES | ZWEITE SERIE

2FH/522

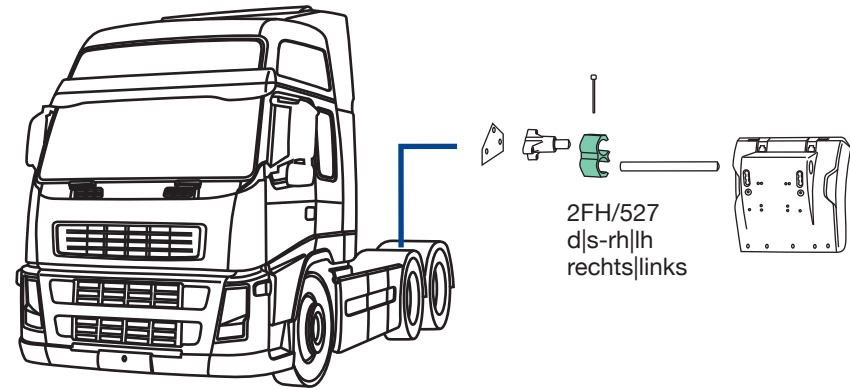
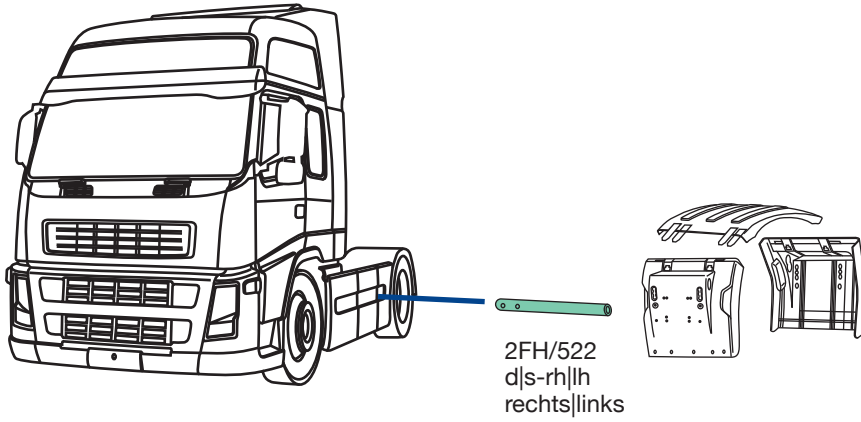
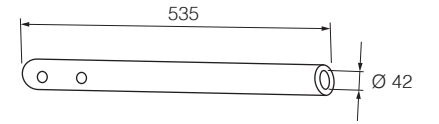

2FH/522
O.E.M. 20375540



2FH/527
O.E.M. 20375489

PRM/630 d-rh-rechts | PRM/632 (*) d-rh-rechts

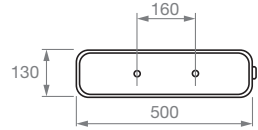

PRM/631 s-lh-links

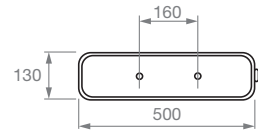

FM7-FM10-FM12 SECONDA SERIE | SECOND SERIES | ZWEITE SERIE

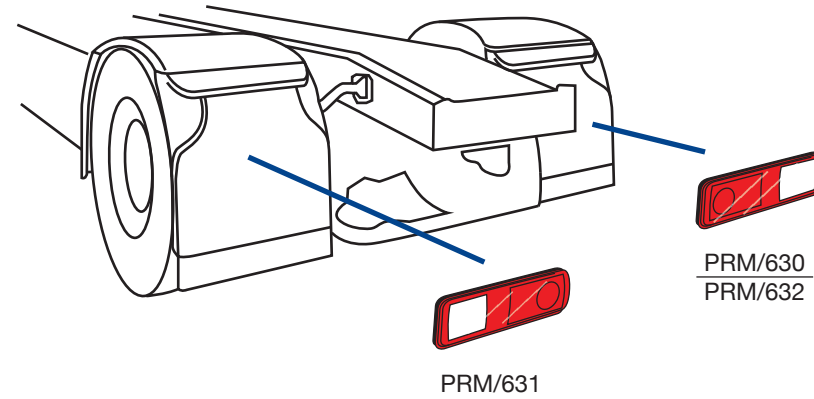

PRM/630
O.E.M. 20769776



PRM/631
O.E.M. 20769775



PRM/632
O.E.M. 20769777

applicabile a | suitable to | verwendbar für:

FM7-FM10-FM12 SECONDA SERIE | SECOND SERIES | ZWEITE SERIE

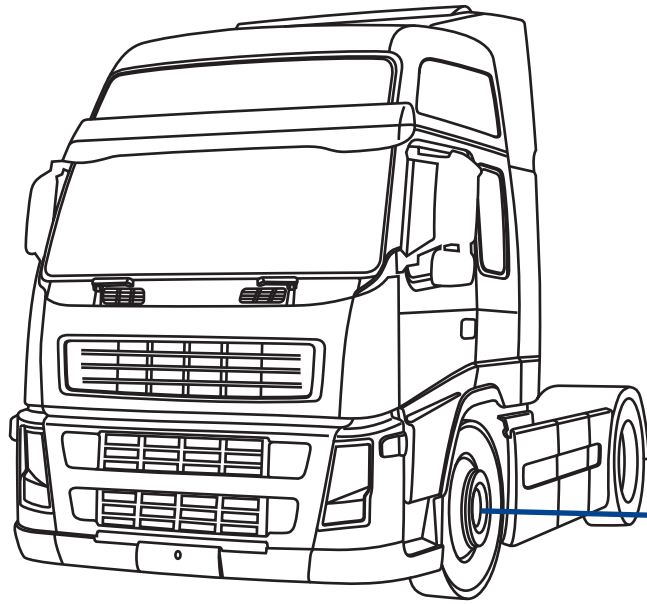

930/033

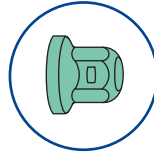

930/001
d-rh-rechts
930/002
s-lh-links



930/200
d|s-rh|lh
rechts|links

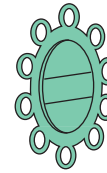

930/100
d-rh-rechts
930/101
s-lh-links



PRM/700
d|s-rh|lh-rechts|links
PRM/710
d|s-rh|lh-rechts|links



930/033
O.E.M. -



930/001
O.E.M. -
930/002
O.E.M. -



930/100
O.E.M. -
930/101
O.E.M. -



930/200
O.E.M. -



PRM/700
O.E.M. 22709903



PRM/710
O.E.M. -

FM7-FM10-FM12 SECONDA SERIE | SECOND SERIES | ZWEITE SERIE

930/033-Tappo copri Bullone-Bolt cover-Radmutterkappen

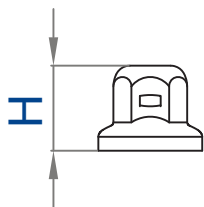

H	45 mm
Per bulloni \varnothing - bolt \varnothing	33 mm
Schlüsselweite \varnothing	
Colore	cromato-chrome-verchromt
Colours-Farbe	
Materiale-Material	acciaio inox-stainless steel Edelstahl
Kg	0,025

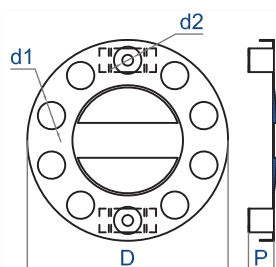

930/001 d-rh-rechts 930/002 s-lh-links	
D \varnothing 425 mm	P 50 mm
d1 nr. 10	d1 \varnothing 58 mm
d2 nr. 2	d2 \varnothing 23 mm
Ventilata	si-yes-Ja
Ventilated-Belüftet	
Colore	cromato e nero-chrome and black
Colours-Farbe	verchromt und schwarz
Materiale-Material	acciaio inox e plastica stainless steel and plastic Edelstahl und Kunststoff
Kg	1,230

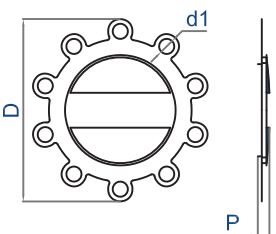

930/100 d-rh-rechts 930/101 s-lh-links	
D \varnothing 387 mm	P 30 mm
d1 nr. 10	d1 \varnothing 32 mm
Ventilata	si-yes-Ja
Ventilated-Belüftet	
Colore	cromato e nero-chrome and black
Colours-Farbe	verchromt und schwarz
Materiale-Material	acciaio inox e plastica stainless steel and plastic Edelstahl und Kunststoff
Kg	0,655

930/200 d|s-rh|lh-rechts+links

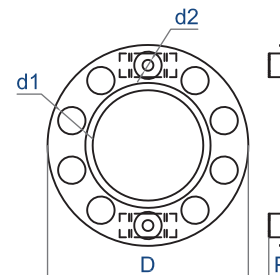

D \varnothing 425 mm	P 40 mm
d1 nr. 10	d1 \varnothing 58 mm
d2 nr. 2	d2 \varnothing 23 mm
Ventilata	no-nein
Ventilated-Belüftet	
Colore	cromato-chrome-verchromt
Colours-Farbe	
Materiale-Material	acciaio inox-stainless steel Edelstahl
Kg	1,155

PRM/700 d|s-rh|lh-rechts+links

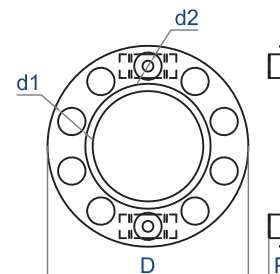

D \varnothing 425 mm	P 40 mm
d1 nr. 10	d1 \varnothing 58 mm
d2 nr. 2	d2 \varnothing 24 mm
Ventilata	no-nein
Ventilated-Belüftet	
Colore	silver-silver-Silber
Colours-Farbe	
Materiale-Material	acciaio inox-stainless steel Edelstahl
Kg	1,700

PRM/710 d|s-rh|lh-rechts+links

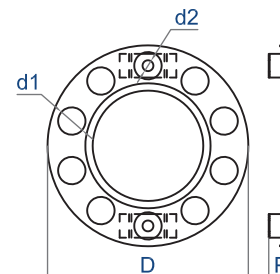

D \varnothing 425 mm	P 40 mm
d1 nr. 10	d1 \varnothing 58 mm
d2 nr. 2	d2 \varnothing 24 mm
Ventilata	no-nein
Ventilated-Belüftet	
Colore	cromato-chrome-verchromt
Colours-Farbe	
Materiale-Material	acciaio inox-stainless steel Edelstahl
Kg	1,700

applicabile a | suitable to | verwendbar für:

FM7-FM10-FM12 SECONDA SERIE | SECOND SERIES | ZWEITE SERIE

XF0/670

0FH/670

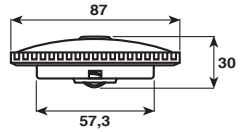

0FH/670



0FH/675

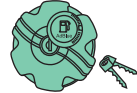

943/670

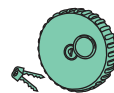

XF0/670

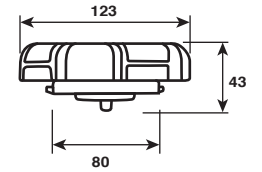
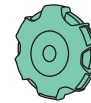

0FH/675

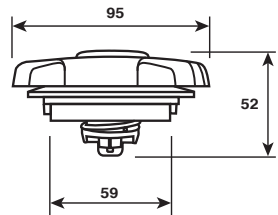

943/670

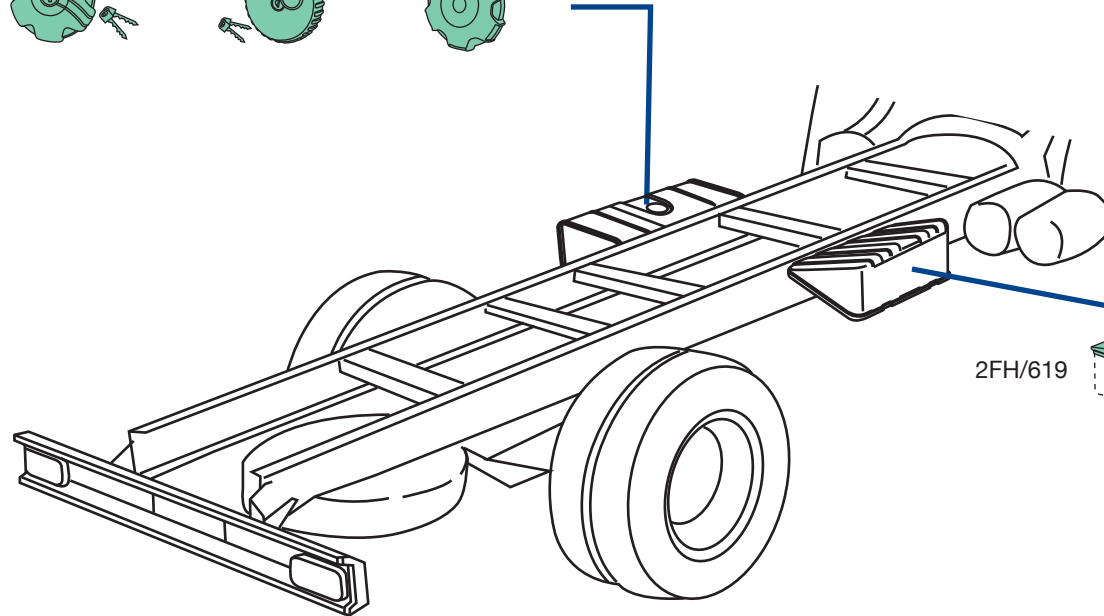
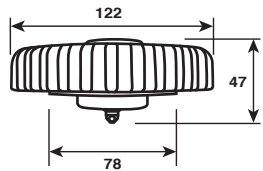

2FH/619

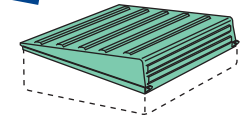

0FH/670
O.E.M. 20896946



0FH/675
O.E.M. 21281403



943/670
O.E.M. 20392752



XF0/670
O.E.M. -



2FH/619
O.E.M. 20507252



applicabile a | suitable to | verwendbar für

111

OFM
FM7-FM10-FM12
(1998→2001)

PRIMA SERIE | FIRST SERIES | ERSTE SERIE

I codici originali sono riportati unicamente per favorire l'identificazione del prodotto | The original codes are indicated for product identification only | Die aufgeführten Originalnummer dienen ausschließlich zu Vergleichszwecken

gallery



H3

E

FM7-FM10-FM12 PRIMA SERIE | FIRST SERIES | ERSTE SERIE



OFH/ 90
O.E.M. 8189329



OFH/ 92
O.E.M. 20372227
OFH/ 93
O.E.M. 20372226



OFH/ 96
O.E.M. 8152722



OFH/650
O.E.M. 1062190

applicabile a | suitable to | verwendbar für:

FM7-FM10-FM12 PRIMA SERIE | FIRST SERIES | ERSTE SERIE

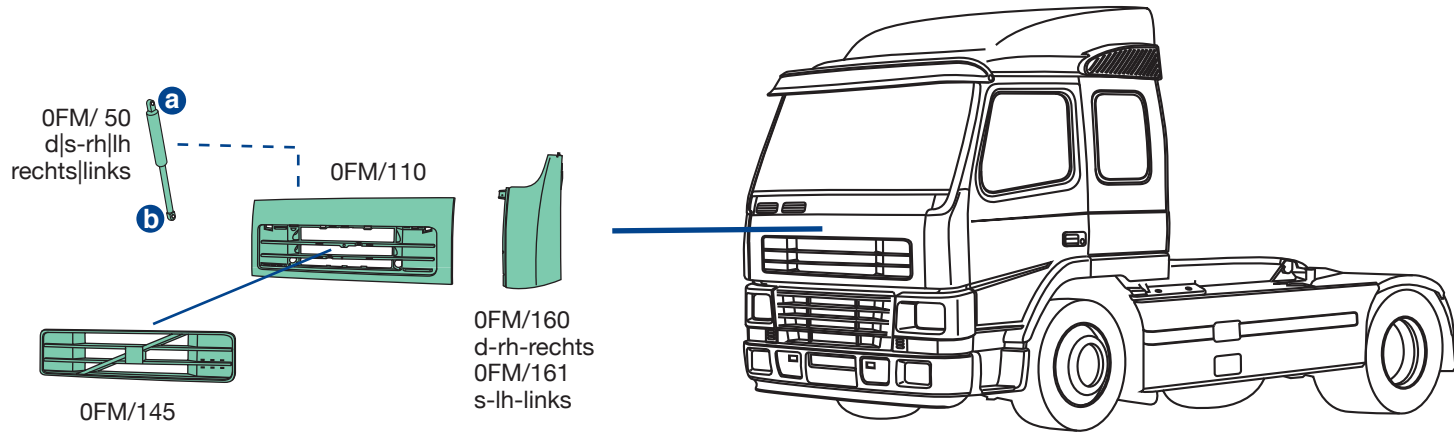

OFM/ 50
O.E.M. 8191439



OFM/110
O.E.M. 8191421



OFM/145
O.E.M. 8191406



OFM/160
O.E.M. 8191412
OFM/161
O.E.M. 8191409

FM7-FM10-FM12 PRIMA SERIE | FIRST SERIES | ERSTE SERIE

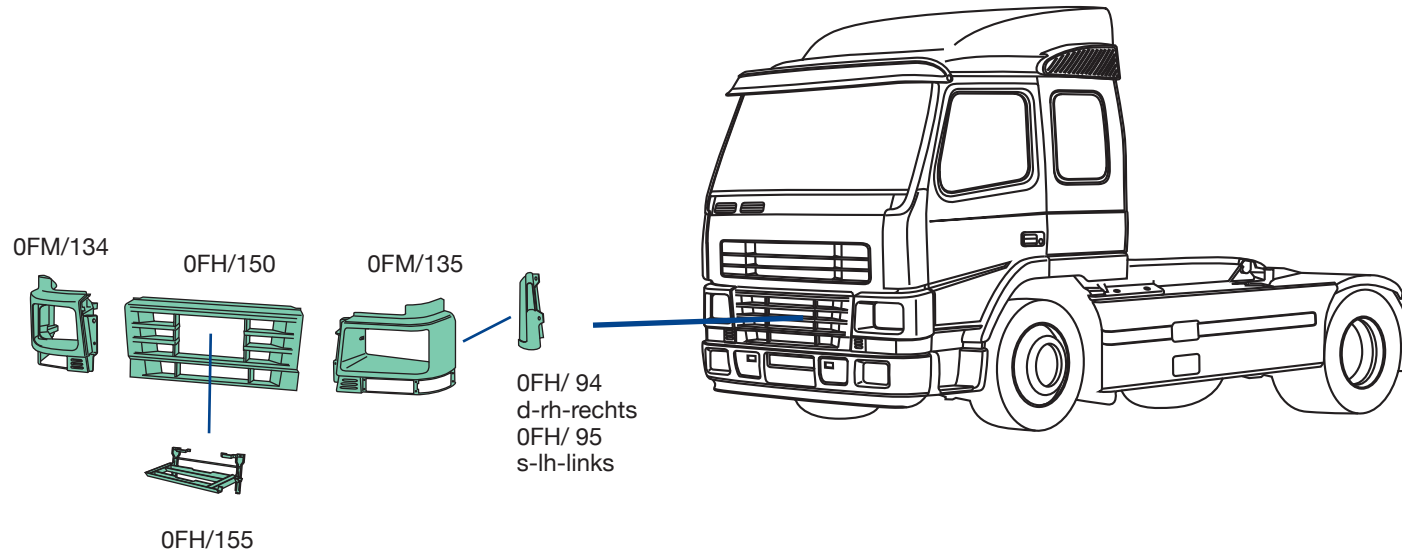

OFM/134
O.E.M. 20398388
OFM/135
O.E.M. 20398387



OFH/94
O.E.M. 8141290
OFH/95
O.E.M. 8141289

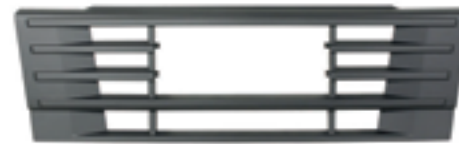

OFH/150
O.E.M. 1063509



OFH/155
O.E.M. 3175863

applicabile a | suitable to | verwendbar für:

FM7-FM10-FM12 PRIMA SERIE | FIRST SERIES | ERSTE SERIE

0FH/710 d|s-rh|lh-rechts|links

1993→2001

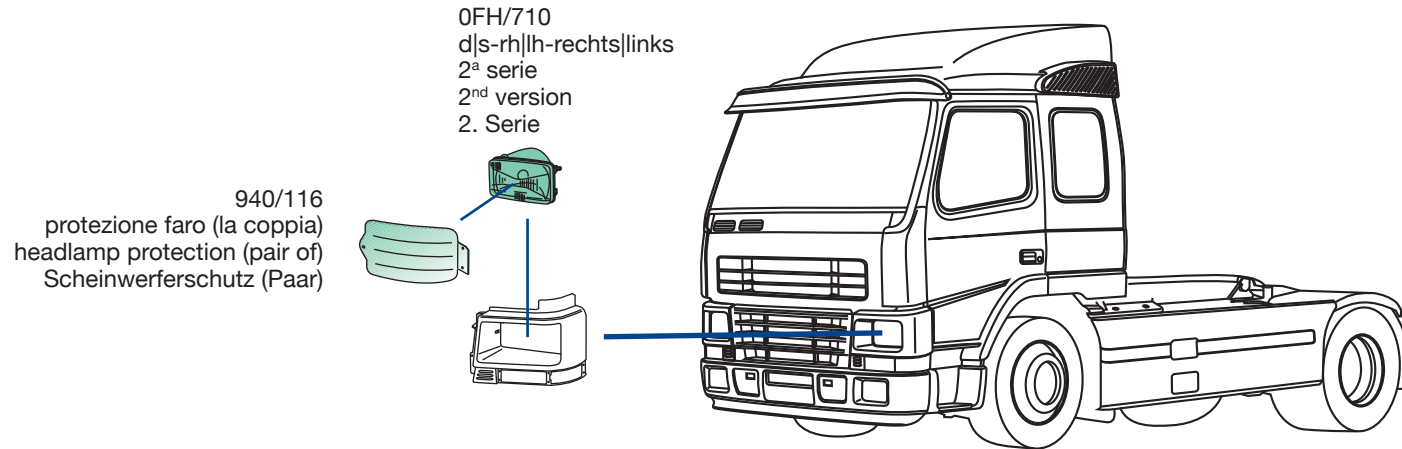

0FH/710
O.E.M. 3981593



940/116
O.E.M. -

OFH/604 d|s-rh|lh-rechts|links 1993→2001



OFH/610 d|s-rh|lh-rechts|links 1993→2001

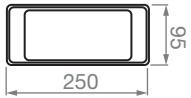

FM7-FM10-FM12 PRIMA SERIE | FIRST SERIES | ERSTE SERIE

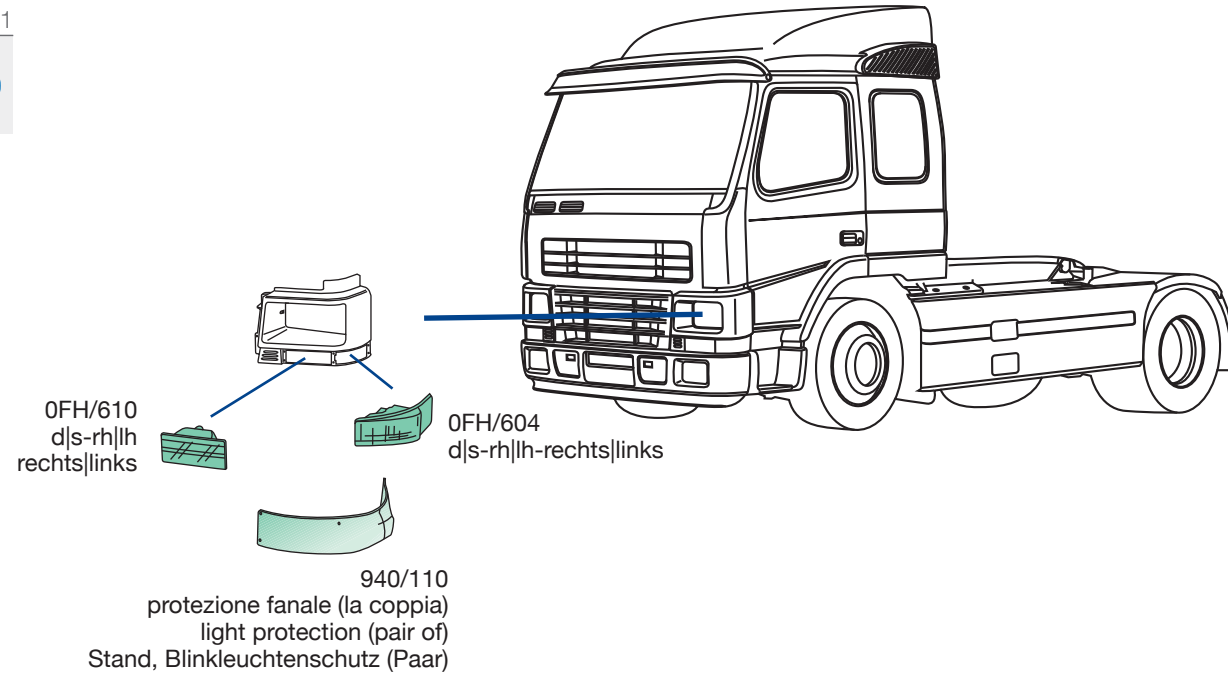

OFH/604
O.E.M. 3981668



OFH/610
O.E.M. 3981666



940/110
O.E.M. -

applicabile a | suitable to | verwendbar für:

FM7-FM10-FM12 PRIMA SERIE | FIRST SERIES | ERSTE SERIE

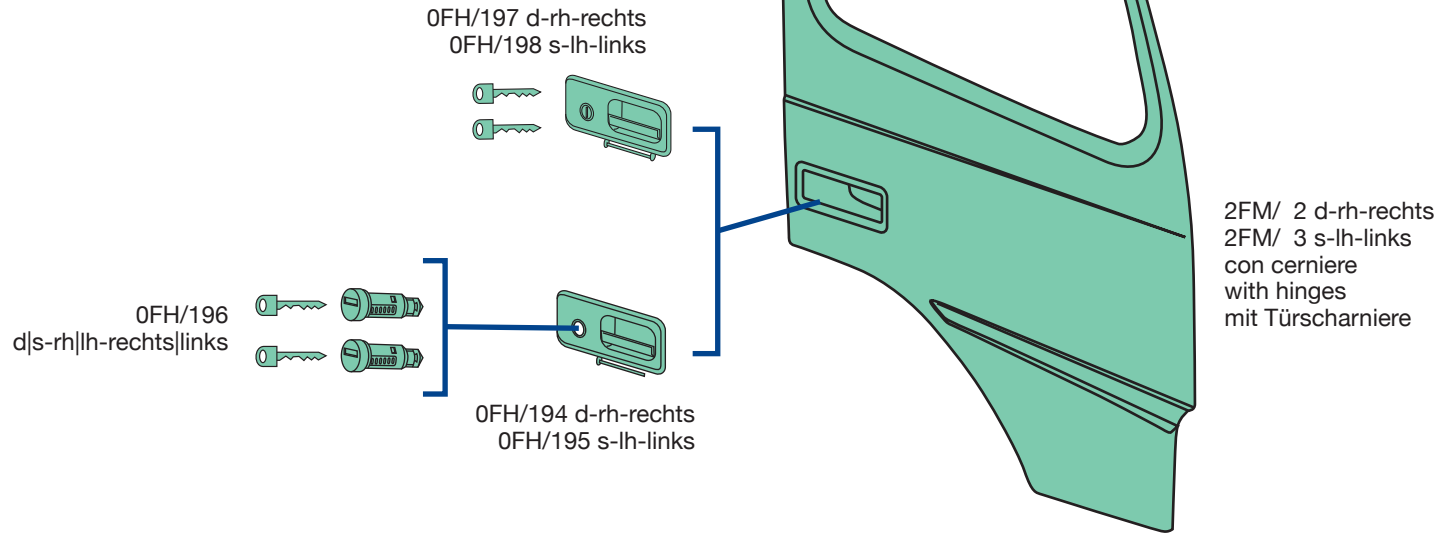

2FM/ 2
O.E.M. 20360850
2FM/ 3
O.E.M. 20360849



OFH/194
O.E.M. 20398467
OFH/195
O.E.M. 20398466



OFH/196
O.E.M. 3090484

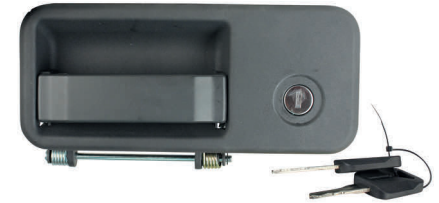

OFH/197
O.E.M. -
OFH/198
O.E.M. -

FM7-FM10-FM12 PRIMA SERIE | FIRST SERIES | ERSTE SERIE

OFH/190

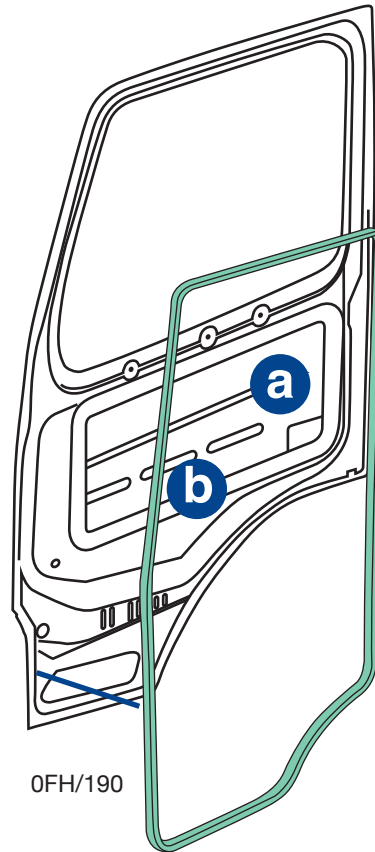
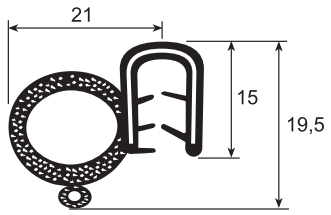

OFH/190

a

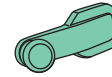

OFM/170
d|s-rh|lh-rechts|links

b

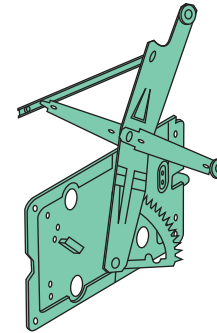

OFM/174 d-rh-rechts
OFM/175 s-lh-links
elettrico, senza motorino
electric, without motor
elektrisch, ohne Motor



OFM/170
O.E.M. 8140016



OFM/174
O.E.M. -
OFM/175
O.E.M. -



OFH/190
O.E.M. 3175029

applicabile a | suitable to | verwendbar für:

FM7-FM10-FM12 PRIMA SERIE | FIRST SERIES | ERSTE SERIE



0FH/508



II

E4 024109

198x433 mm



IV

E4 024110

181x175 mm

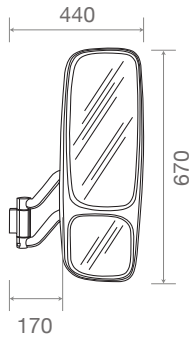

applicabilità:
applicable to:
Verwendbar für

VOLVO 0FH. FH 1993→2002
VOLVO 0FM. FM 1998→2002



COVIND
II
IV

FM7-FM10-FM12 PRIMA SERIE | FIRST SERIES | ERSTE SERIE

a 0FH/512

3091751



240x250 mm

b 0FH/506

20854564
(3092854)

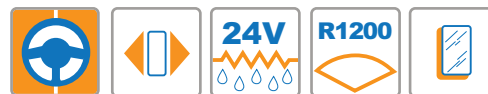

E4 024109

198x433 mm

II

c 0FH/507

21203311

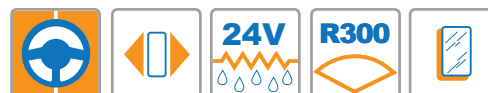

E4 024110

181x175 mm

IV

applicabile a | suitable to | verwendbar für:

FM7-FM10-FM12 PRIMA SERIE | FIRST SERIES | ERSTE SERIE



0FH/509



II

E4 024109

198x433 mm



IV

E4 024110

181x175 mm

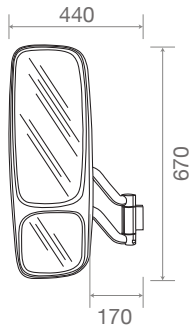

applicabilità:
applicable to:
Verwendbar für

VOLVO 0FH. FH 1993→2002
VOLVO 0FM. FM 1998→2002



COVIND
II
IV

a 0FH/513

3091750



240x250 mm

b 0FH/506

20854564
(3092854)

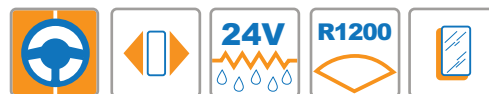

E4 024109

198x433 mm

II

c 0FH/507

21203311

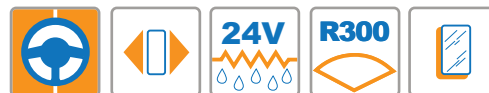

E4 024110

181x175 mm

IV

applicabile a | suitable to | verwendbar für:



FM7-FM10-FM12 PRIMA SERIE | FIRST SERIES | ERSTE SERIE

2FH/506

20854644
(1096643)

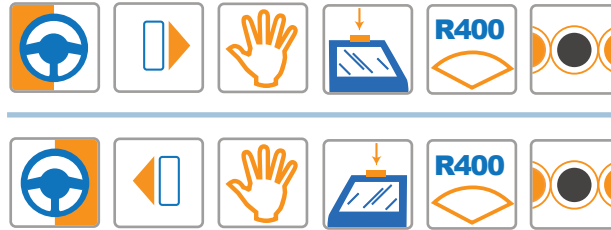

V E9 026322
275x165 mm

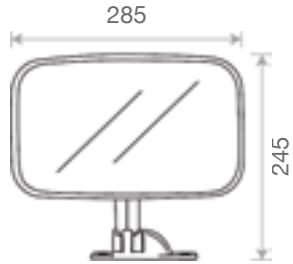

applicabilità:
applicable to:
Verwendbar für

- VOLVO 0FH. FH I
- VOLVO 2FH. FH II
- VOLVO 0FM. FM I
- VOLVO 2FM. FM II





applicabile a | suitable to | verwendbar für:

FM7-FM10-FM12 PRIMA SERIE | FIRST SERIES | ERSTE SERIE

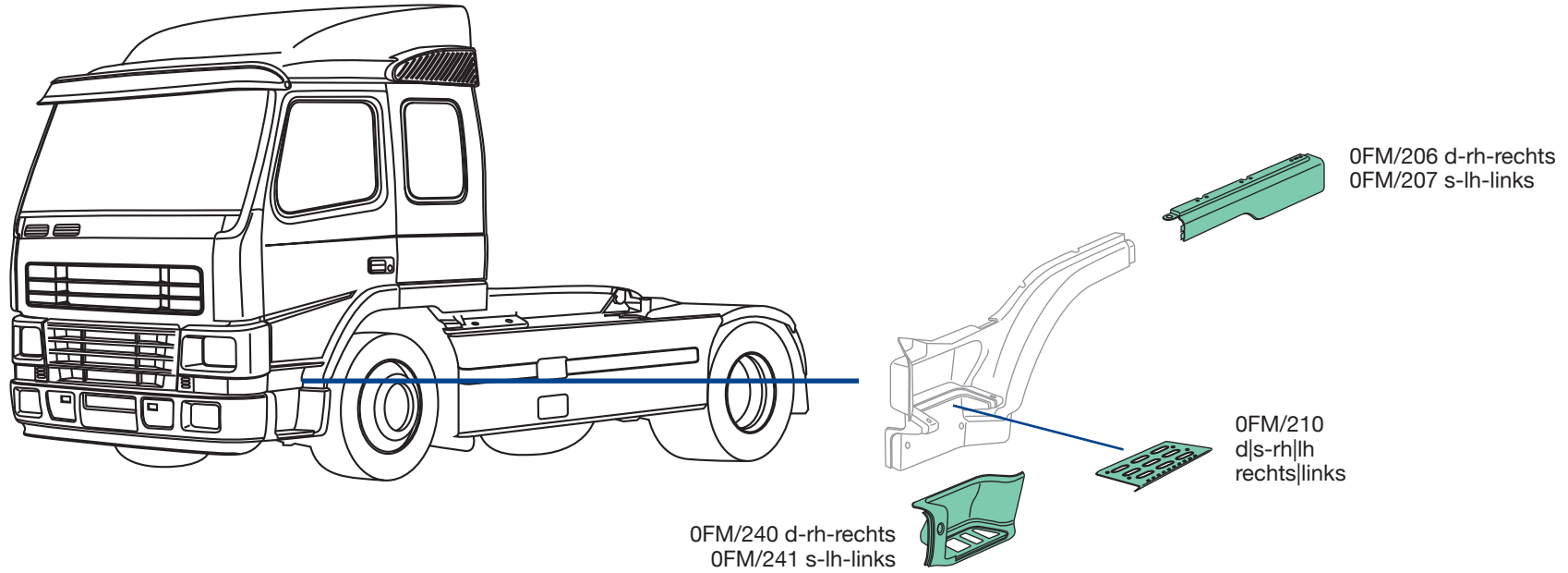

0FM/206
O.E.M. 20530083
0FM/207
O.E.M. 20530082



0FM/210
O.E.M. 1063726



0FM/240
O.E.M. 1062134
0FM/241
O.E.M. 8191593

FM7-FM10-FM12 PRIMA SERIE | FIRST SERIES | ERSTE SERIE

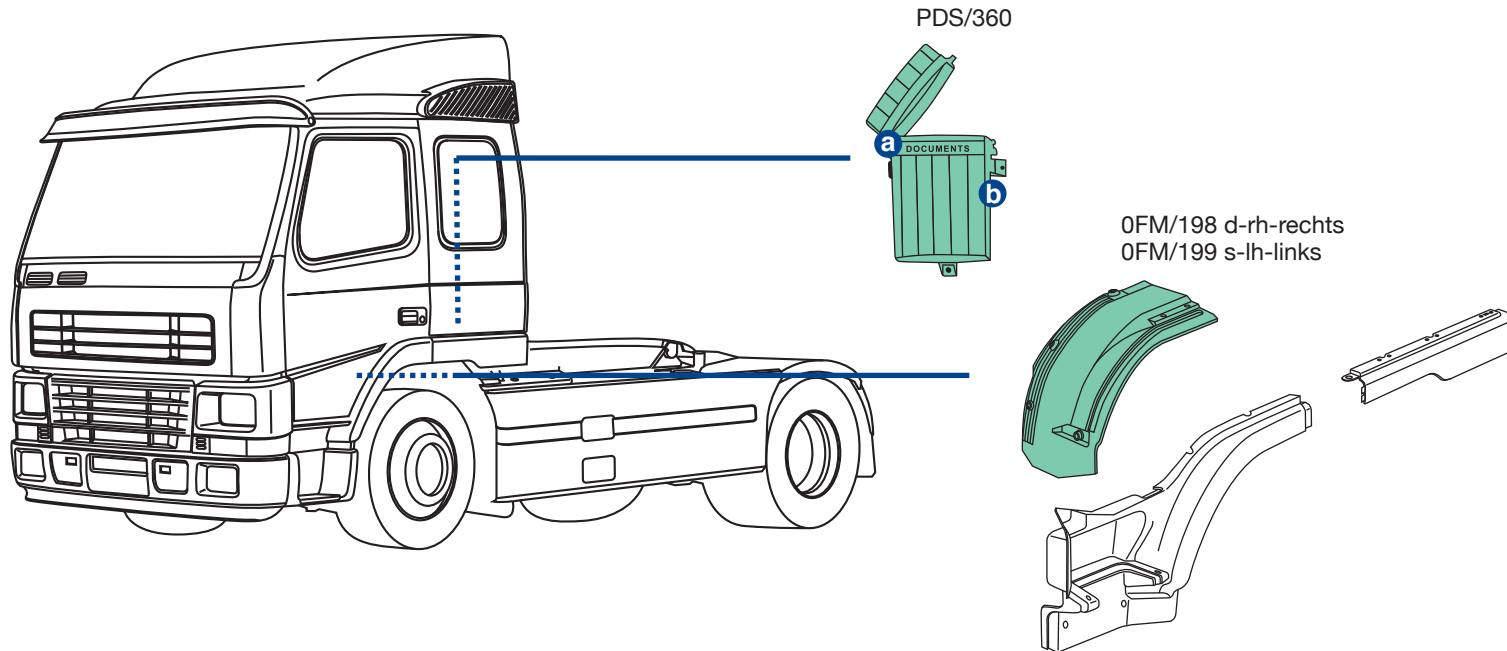

PDS/360
O.E.M. -

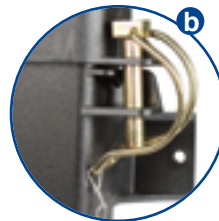

OFM/198
O.E.M. 8191781
OFM/199
O.E.M. 8191780

applicabile a | suitable to | verwendbar für:

FM7-FM10-FM12 PRIMA SERIE | FIRST SERIES | ERSTE SERIE

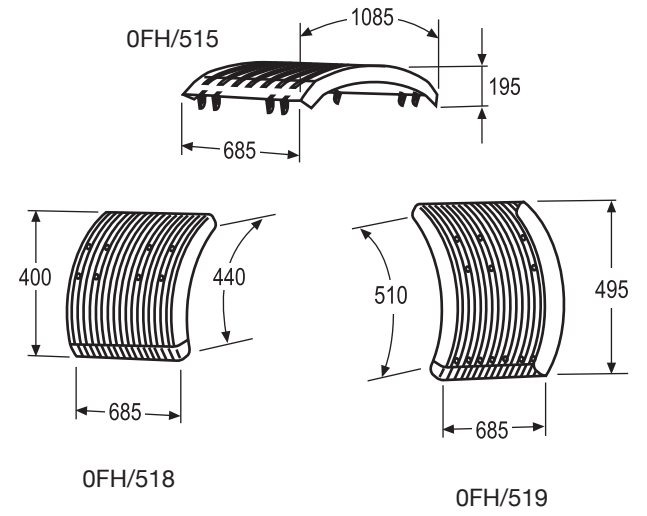
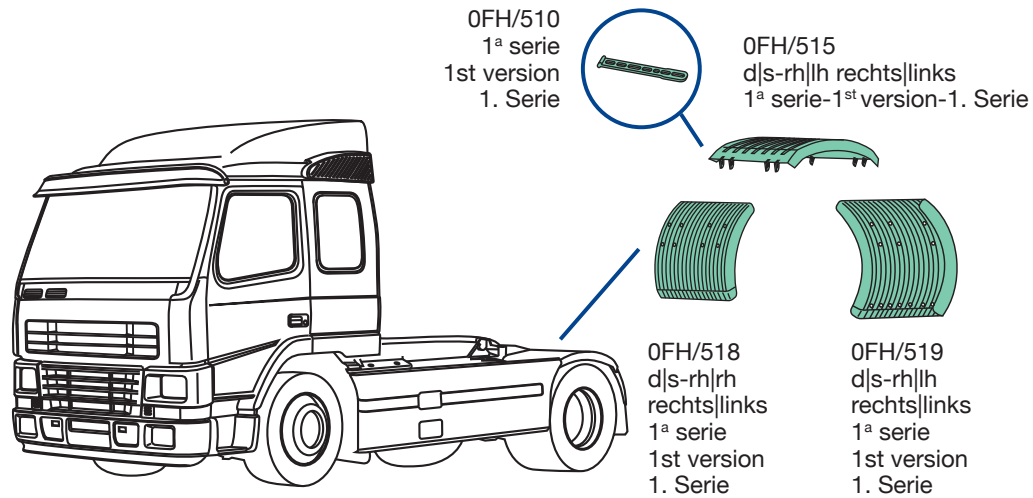

OFH/510
O.E.M. 8156556

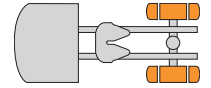

0FH/515
 O.E.M. 8190106
 d|s-rh|lh-rechts|links
 nero, semipiatta, con cinghietti
 black, semi-flat, with stretchers
 schwarz, halbfach, mit Spanngummi



0FH/519
 O.E.M. 8156554
 d|s-rh|lh-rechts|links
 nero, senza anti-spray
 black, without anti-spray
 schwarz, ohne Spritzschutz



0FH/518
 O.E.M. 8156551
 d|s-rh|lh-rechts|links
 nero-black-schwarz

FM7-FM10-FM12 PRIMA SERIE | FIRST SERIES | ERSTE SERIE

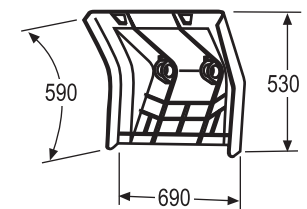
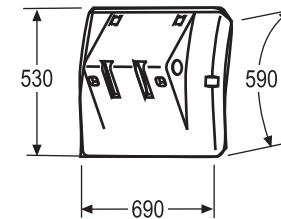
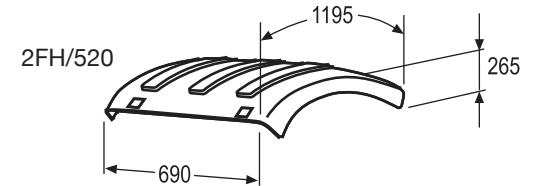
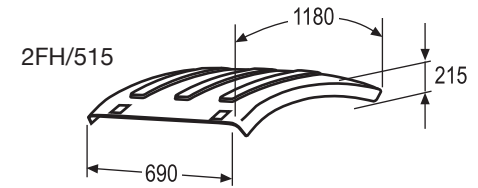
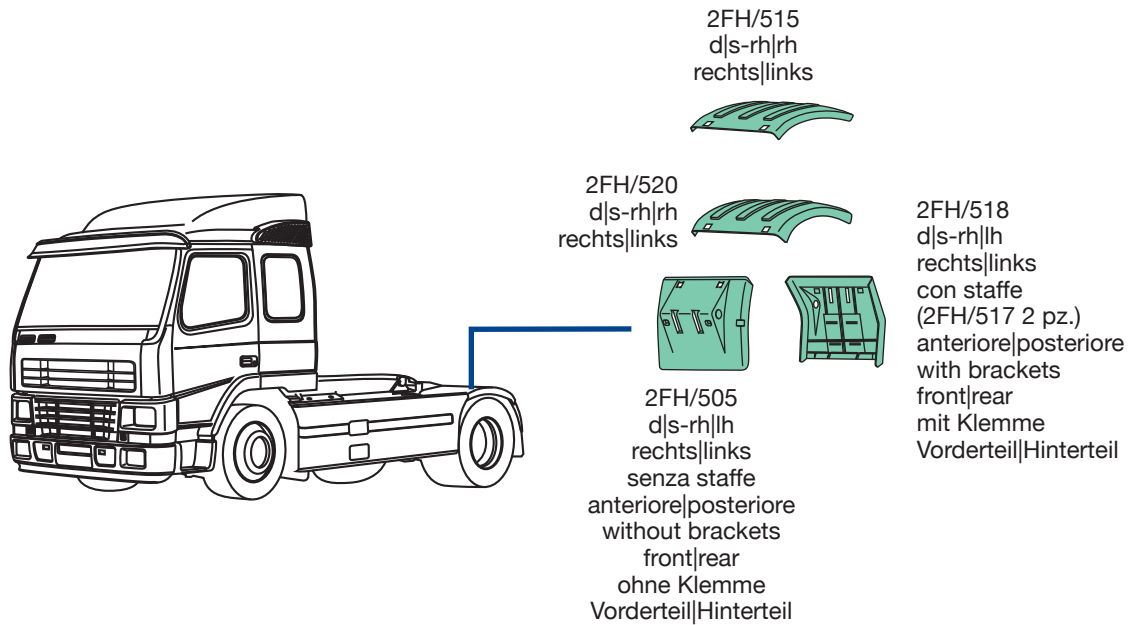

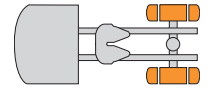

2FH/515
 O.E.M. 20936759
 d|s-rh|lh-rechts|links
 nero, semipiatta, senza cinghietti
 black, semi-flat, without stretchers
 schwarz, halbfach, ohne Spanngummi



2FH/518
 O.E.M. 20392599
 d|s-rh|lh-rechts|links
 nero, senza anti-spray, con staffe
 black, without anti-spray, with brackets
 schwarz, ohne Spritzschutz, mit Klemme



2FH/520
 O.E.M. 20936769
 d|s-rh|lh-rechts|links
 nero, circolare, senza cinghietti
 black, circular, without stretchers
 schwarz, kreisförmig, ohne Spanngummi



2FH/505
 O.E.M. 20392544
 d|s-rh|lh-rechts|links
 nero, senza staffe
 black, without brackets
 schwarz, ohne Klemme

2FH/505

2FH/518

applicabile a | suitable to | verwendbar für:

FM7-FM10-FM12 PRIMA SERIE | FIRST SERIES | ERSTE SERIE

(*) Applicabile con il cinghietto 2FH/510
Applied with stretcher 2FH/510
bestückt mit 2FH/510

(°) Applicabile con il cinghietto PRM/515
Applied with stretcher PRM/515
bestückt mit PRM/515

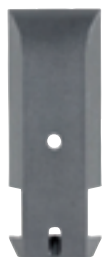
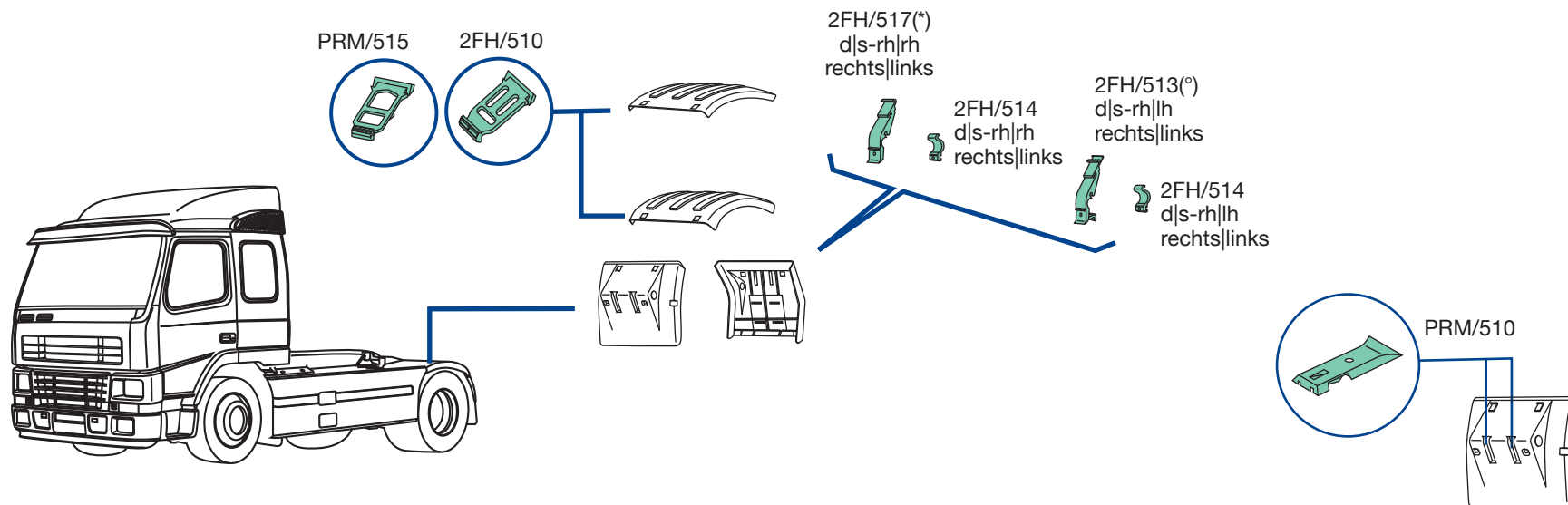

PRM/510
O.E.M. 20721840



PRM/515
O.E.M. 20498623



2FH/510
O.E.M. 1079981



2FH/513
O.E.M. 20583434

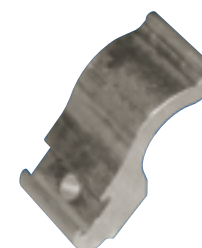

2FH/514
O.E.M. 20583440



2FH/517
O.E.M. 3987252

(*) adattabile a 2FH/505
 suitable to 2FH/505
 passend für 2FH/505

FM7-FM10-FM12 PRIMA SERIE | FIRST SERIES | ERSTE SERIE

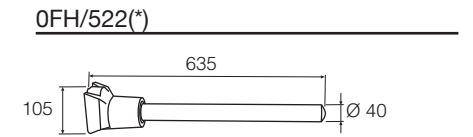
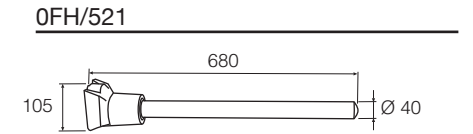
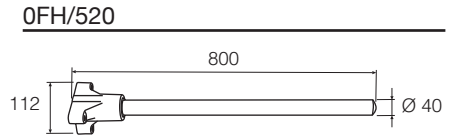
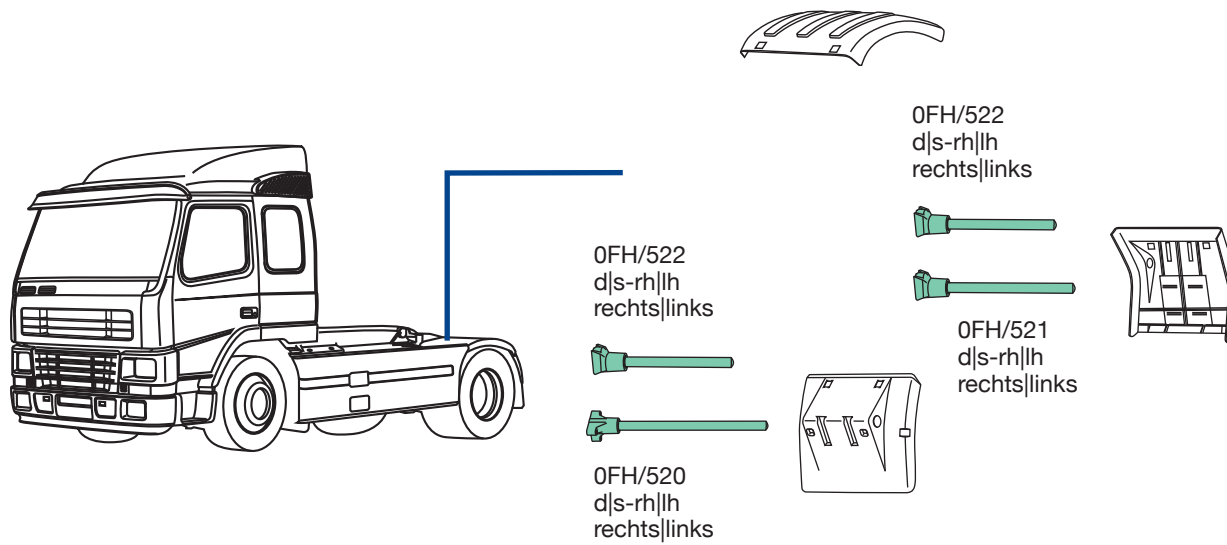

0FH/520
 O.E.M. 8154385



0FH/521
 O.E.M. 20466895



0FH/522
 O.E.M. 20466894

applicabile a | suitable to | verwendbar für:

FM7-FM10-FM12 PRIMA SERIE | FIRST SERIES | ERSTE SERIE

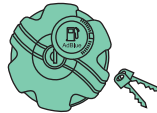
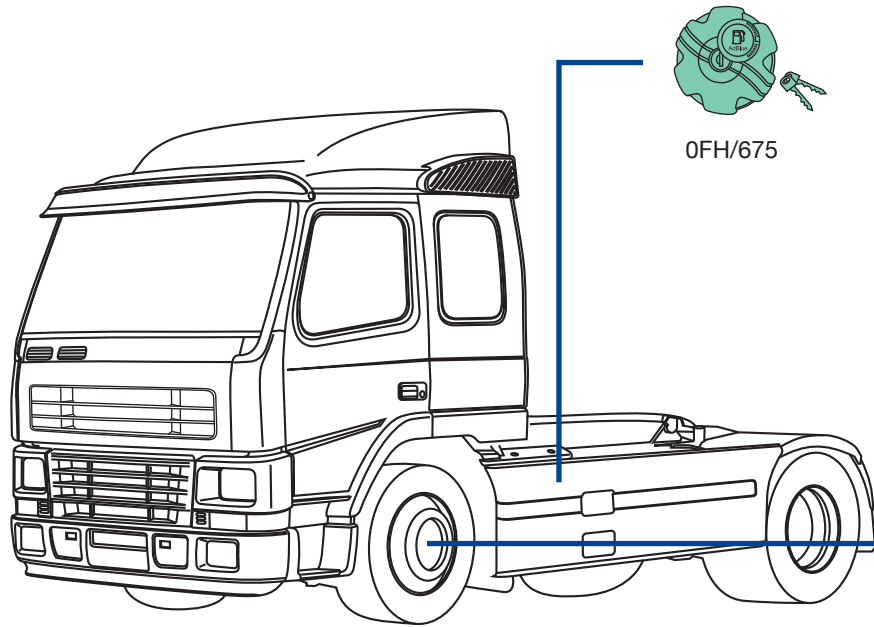

OFH/675

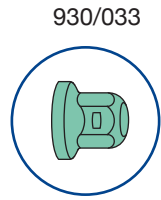

930/033



930/001
d-rh-rechts
930/002
s-lh-links



930/200
d|s-rh|lh
rechts|links

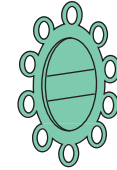

930/100
d-rh-rechts
930/101
s-lh-links

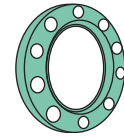

PRM/700
d|s-rh|lh-rechts|links
PRM/710
d|s-rh|lh-rechts|links

OFH/675

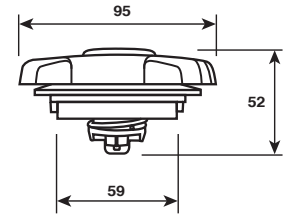

OFH/675
O.E.M. 21281403



930/033
O.E.M. -



930/001
O.E.M. -
930/002
O.E.M. -



930/100
O.E.M. -
930/101
O.E.M. -



930/200
O.E.M. -



PRM/700
O.E.M. 22709903



PRM/710
O.E.M. -

FM7-FM10-FM12 PRIMA SERIE | FIRST SERIES | ERSTE SERIE

930/033-Tappo copri Bullone-Bolt cover-Radmutterkappen

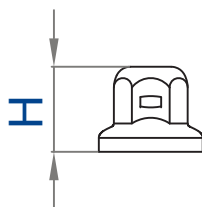

H	45 mm
Per bulloni \varnothing - bolt \varnothing	33 mm
Schlüsselweite \varnothing	
Colore	cromato-chrome-verchromt
Colours-Farbe	
Materiale-Material	acciaio inox-stainless steel
	Edelstahl
Kg	0,025

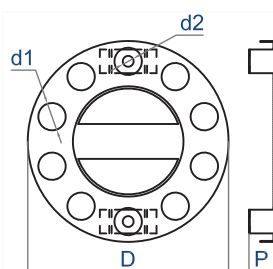

930/001 d-rh-rechts | 930/002 s-lh-links

D \varnothing 425 mm	P 50 mm
d1 nr. 10	d1 \varnothing 58 mm
d2 nr. 2	d2 \varnothing 23 mm
Ventilata	si-yes-Ja
Ventilated-Belüftet	
Colore	cromato e nero-chrome and black
Colours-Farbe	verchromt und schwarz
Materiale-Material	acciaio inox e plastica
	stainless steel and plastic
	Edelstahl und Kunststoff
Kg	1,230

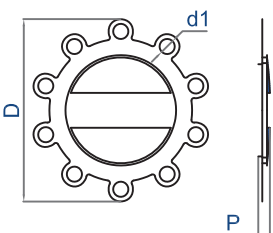

930/100 d-rh-rechts | 930/101 s-lh-links

D \varnothing 387 mm	P 30 mm
d1 nr. 10	d1 \varnothing 32 mm
Ventilata	si-yes-Ja
Ventilated-Belüftet	
Colore	cromato e nero-chrome and black
Colours-Farbe	verchromt und schwarz
Materiale-Material	acciaio inox e plastica
	stainless steel and plastic
	Edelstahl und Kunststoff
Kg	0,655

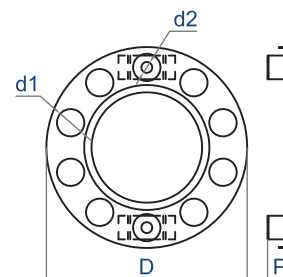

930/200 d|s-rh|lh-rechts+links

D \varnothing 425 mm	P 40 mm
d1 nr. 10	d1 \varnothing 58 mm
d2 nr. 2	d2 \varnothing 23 mm
Ventilata	no-nein
Ventilated-Belüftet	
Colore	cromato-chrome-verchromt
Colours-Farbe	
Materiale-Material	acciaio inox-stainless steel
	Edelstahl
Kg	1,155

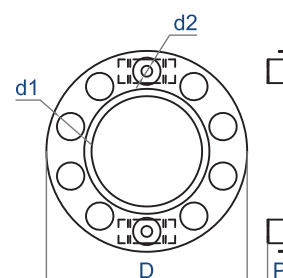

PRM/700 d|s-rh|lh-rechts+links

D \varnothing 425 mm	P 40 mm
d1 nr. 10	d1 \varnothing 58 mm
d2 nr. 2	d2 \varnothing 24 mm
Ventilata	no-nein
Ventilated-Belüftet	
Colore	silver-silver-Silber
Colours-Farbe	
Materiale-Material	acciaio inox-stainless steel
	Edelstahl
Kg	1,700

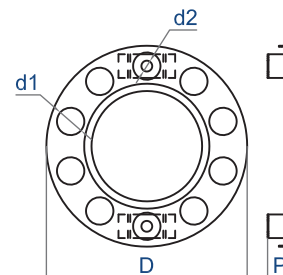

PRM/710 d|s-rh|lh-rechts+links

D \varnothing 425 mm	P 40 mm
d1 nr. 10	d1 \varnothing 58 mm
d2 nr. 2	d2 \varnothing 24 mm
Ventilata	no-nein
Ventilated-Belüftet	
Colore	cromato-chrome-verchromt
Colours-Farbe	
Materiale-Material	acciaio inox-stainless steel
	Edelstahl
Kg	1,700

gallery





applicabile a | suitable to | verwendbar für

137

4HR
FH Euro 6
RESTYLING

applicabile a | suitable to | verwendbar für:

FH Euro 6 Restyling

(°) ferro - iron - Stahl

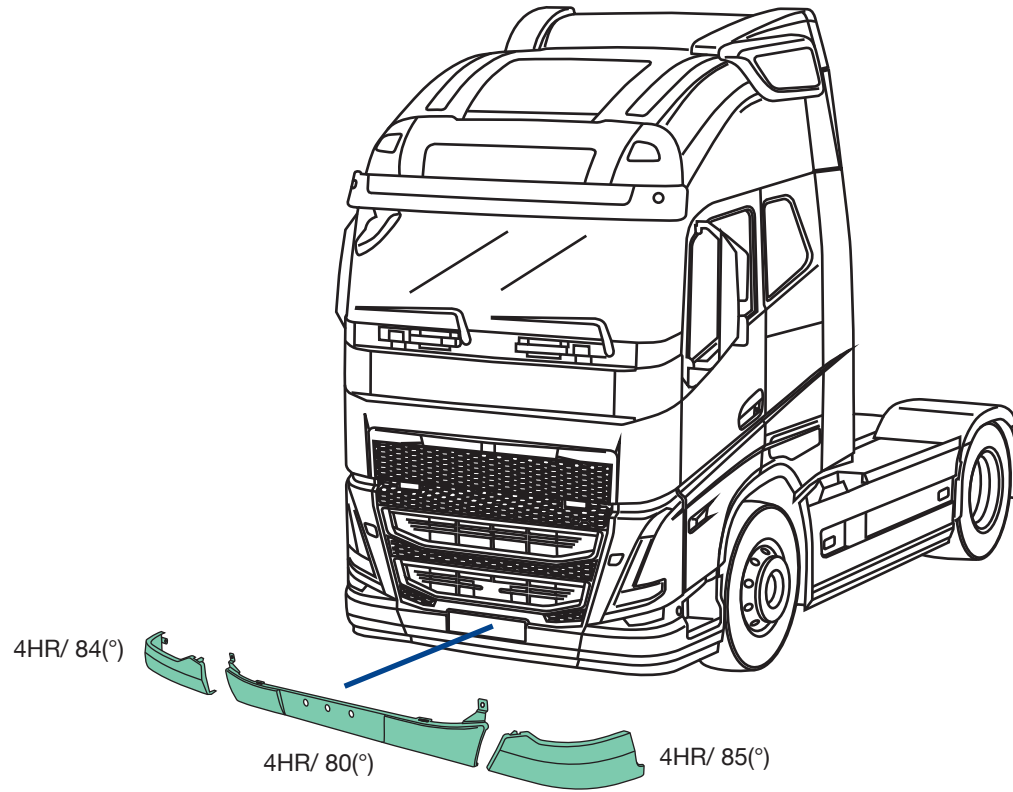

4HR/ 80
O.E.M. 22247766



4HR/ 84
O.E.M. 82694422
4HR/ 85
O.E.M. 82694421

FH Euro 6 Restyling

(*) plastica, liscio, nero
plastic, smooth, black
Kunststoff, glatt, schwarz

(°) plastica, goffrato, grigio
plastic, textured, grey
Kunststoff, Geprägte, grau

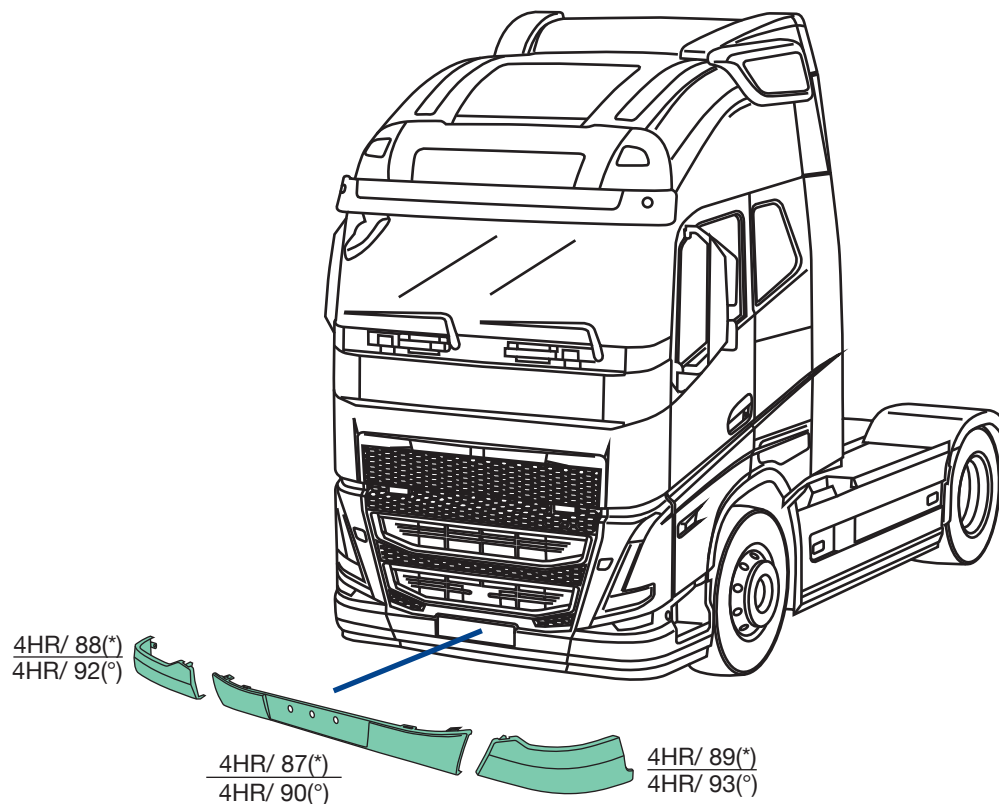

4HR/ 87
O.E.M. 84195623



4HR/ 90
O.E.M. 22249883



4HR/ 88
O.E.M. 22766195
4HR/ 89
O.E.M. 22766194



4HR/ 92
O.E.M. 84205718
4HR/ 93
O.E.M. 84205716

applicabile a | suitable to | verwendbar für:

FH Euro 6 Restyling

(*) plastica, liscio, nero
plastic, smooth, black
Kunststoff, glatt, schwarz

(°) plastica, gofrato, grigio
plastic, textured, grey
Kunststoff, Geprägte, grau

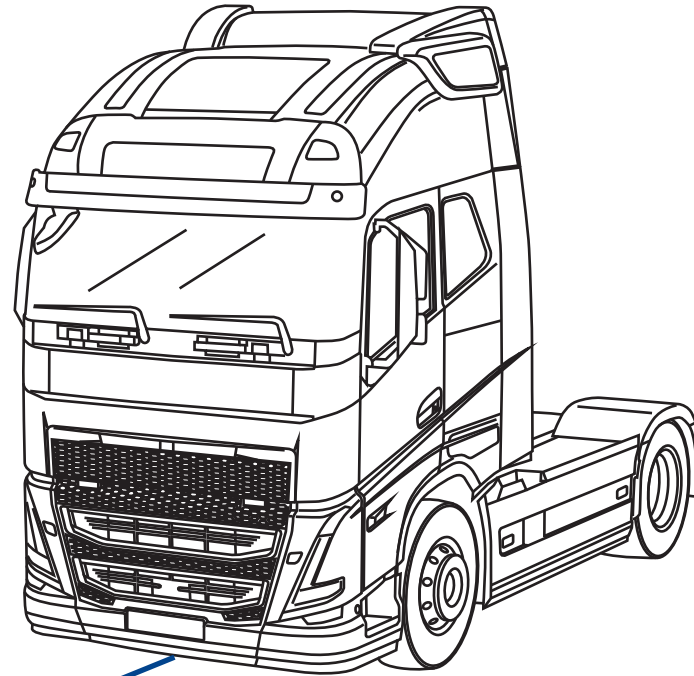

4HR/ 96(*)
4HR/104(°)



4HR/ 95(*)
4HR/102(°)

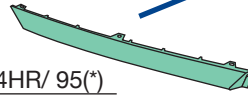

4HR/ 97(*)
4HR/105(°)



4HR/ 96
O.E.M. 22671460
4HR/ 97
O.E.M. 22671508



4HR/ 95
O.E.M. 22245579



4HR/102
O.E.M. 84038586



4HR/104
O.E.M. 82674762
4HR/105
O.E.M. 82674760

FH Euro 6 Restyling

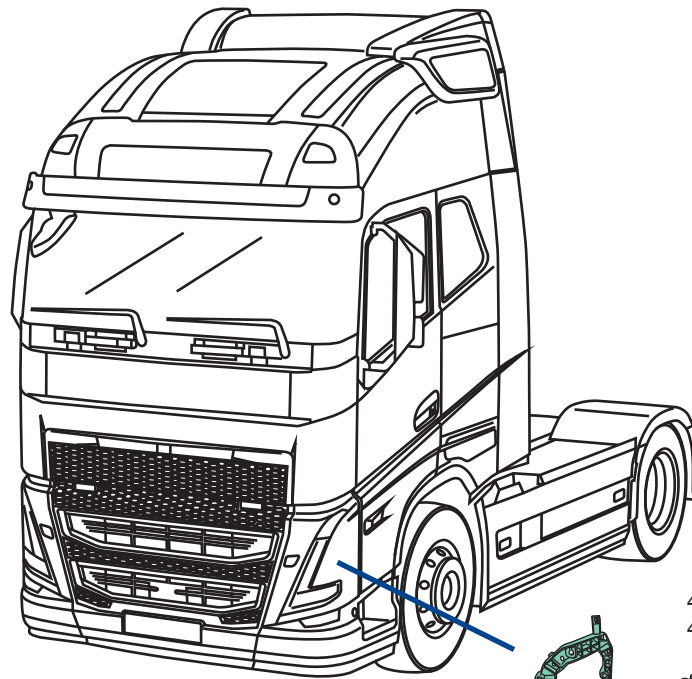

4HR/ 98 d-rh-rechts
4HR/ 99 s-lh-links



4HR/134 d-rh-rechts
4HR/135 s-lh-links

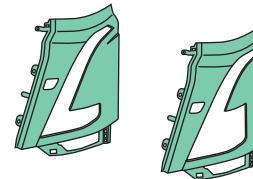

4HR/434 d-rh-rechts
4HR/435 s-lh-links



4HR/ 98
O.E.M. 84234669
4HR/ 99
O.E.M. 842336uo



4HR/134
O.E.M. 84448800
4HR/135
O.E.M. 84448796



4HR/434
O.E.M. 84448715
4HR/435
O.E.M. 84449120

gallery

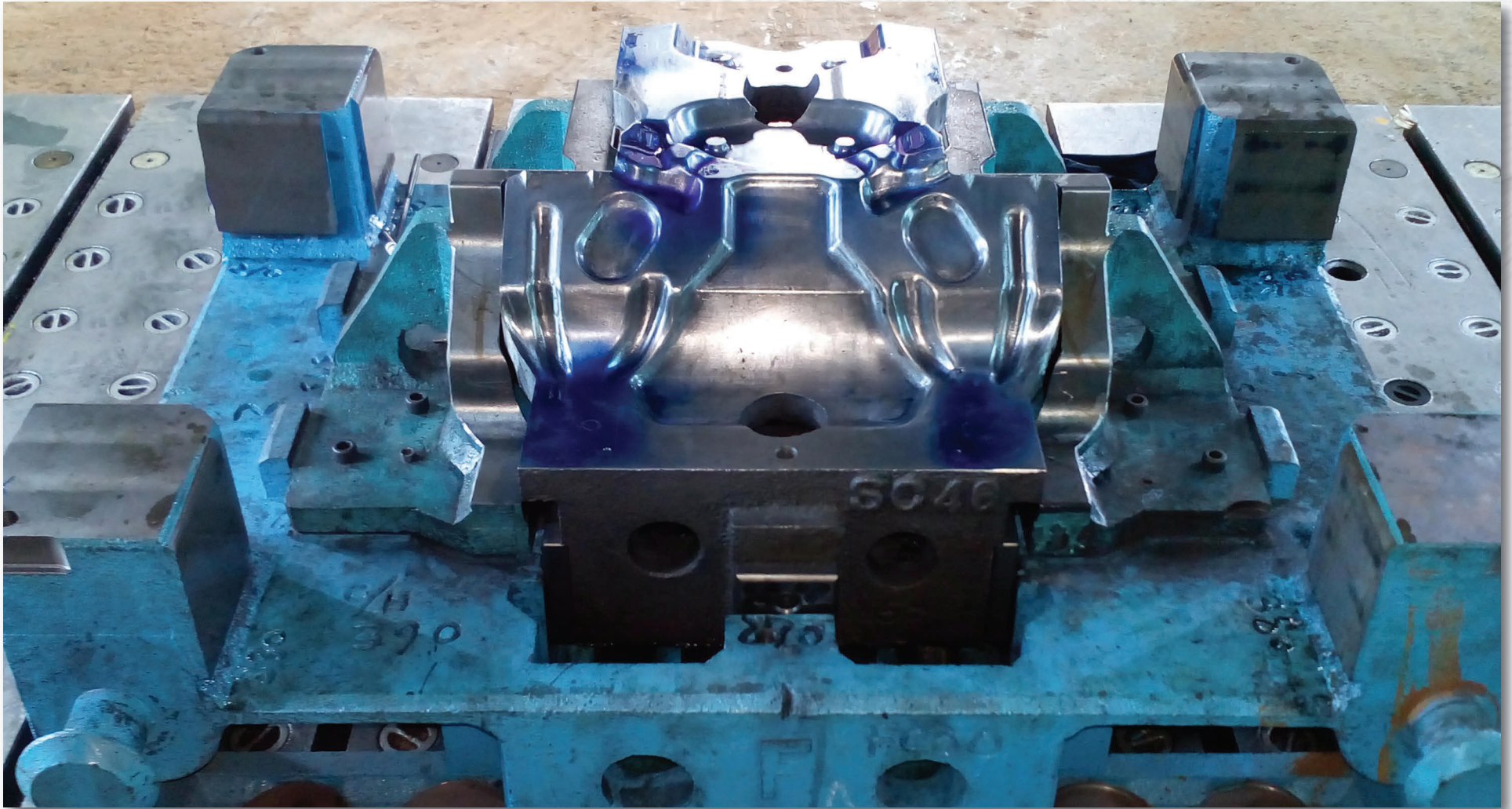



applicabile a | suitable to | verwendbar für

143

4FH

FH Euro 6 (2013→)

applicabile a | suitable to | verwendbar für:

FH Euro 6

(°) ferro - iron - Stahl

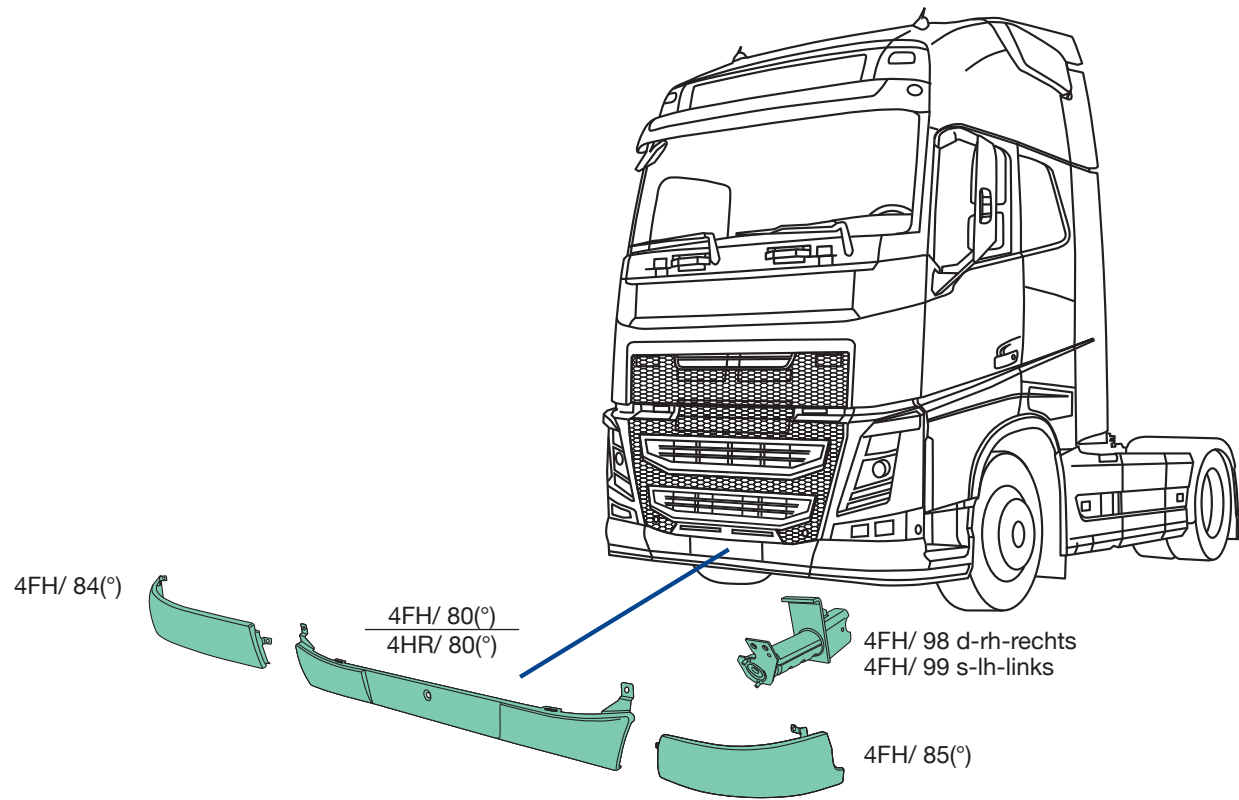

4FH/ 80
O.E.M. 21838943



4HR/ 80
O.E.M. 22247766



4FH/ 84
O.E.M. 21838945
4FH/ 85
O.E.M. 21838944



4FH/ 98
O.E.M. 82943981
4FH/ 99
O.E.M. 82928883

(*) plastica, liscio, nero
plastic, smooth, black
Kunststoff, glatt, schwarz

(°) plastica, gofrato, grigio
plastic, textured, grey
Kunststoff, Geprägte, grau

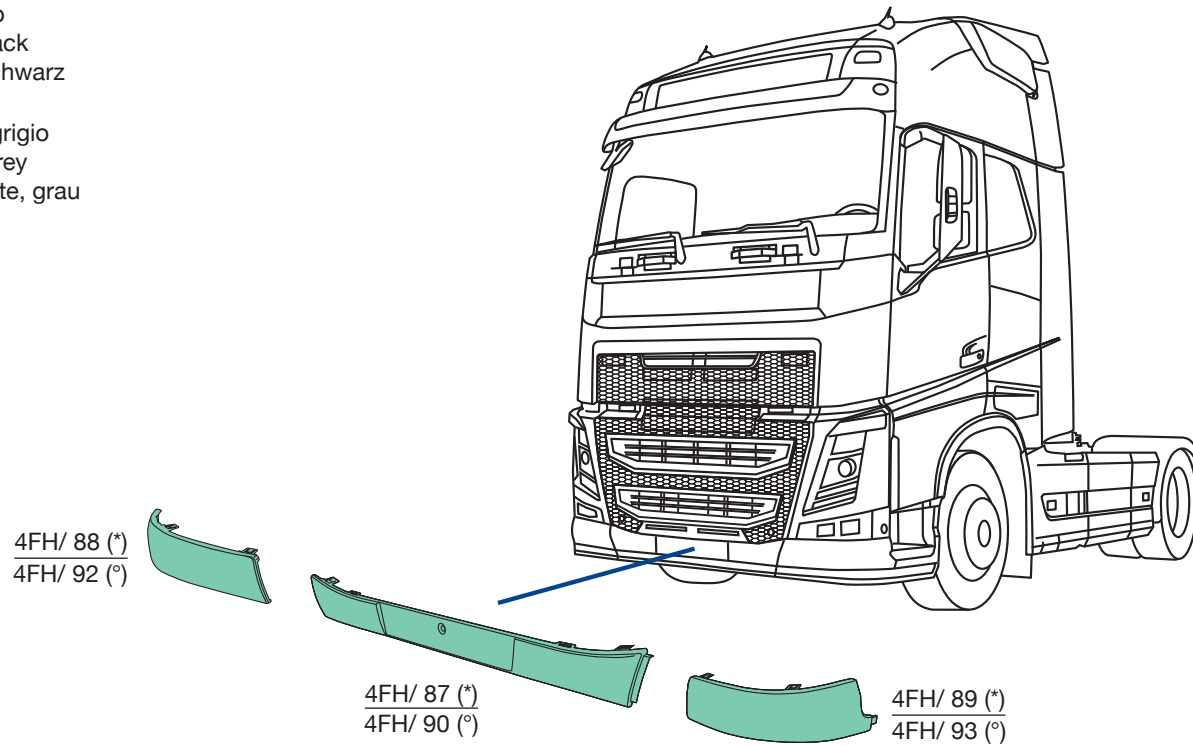

4FH/ 87
O.E.M. 2143787



4FH/ 88
O.E.M. 21413786
4FH/ 89
O.E.M. 21413789

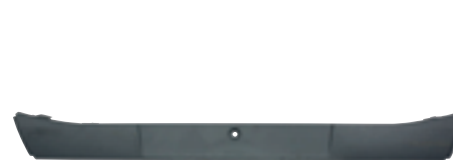

4FH/ 90
O.E.M. 21316576



4FH/ 92
O.E.M. 21316577
4FH/ 93
O.E.M. 21316575

applicabile a | suitable to | verwendbar für:

FH Euro 6

(*) plastica, liscio, nero
plastic, smooth, black
Kunststoff, glatt, schwarz

(°) plastica, gofrato, grigio
plastic, textured, grey
Kunststoff, Geprägte, grau

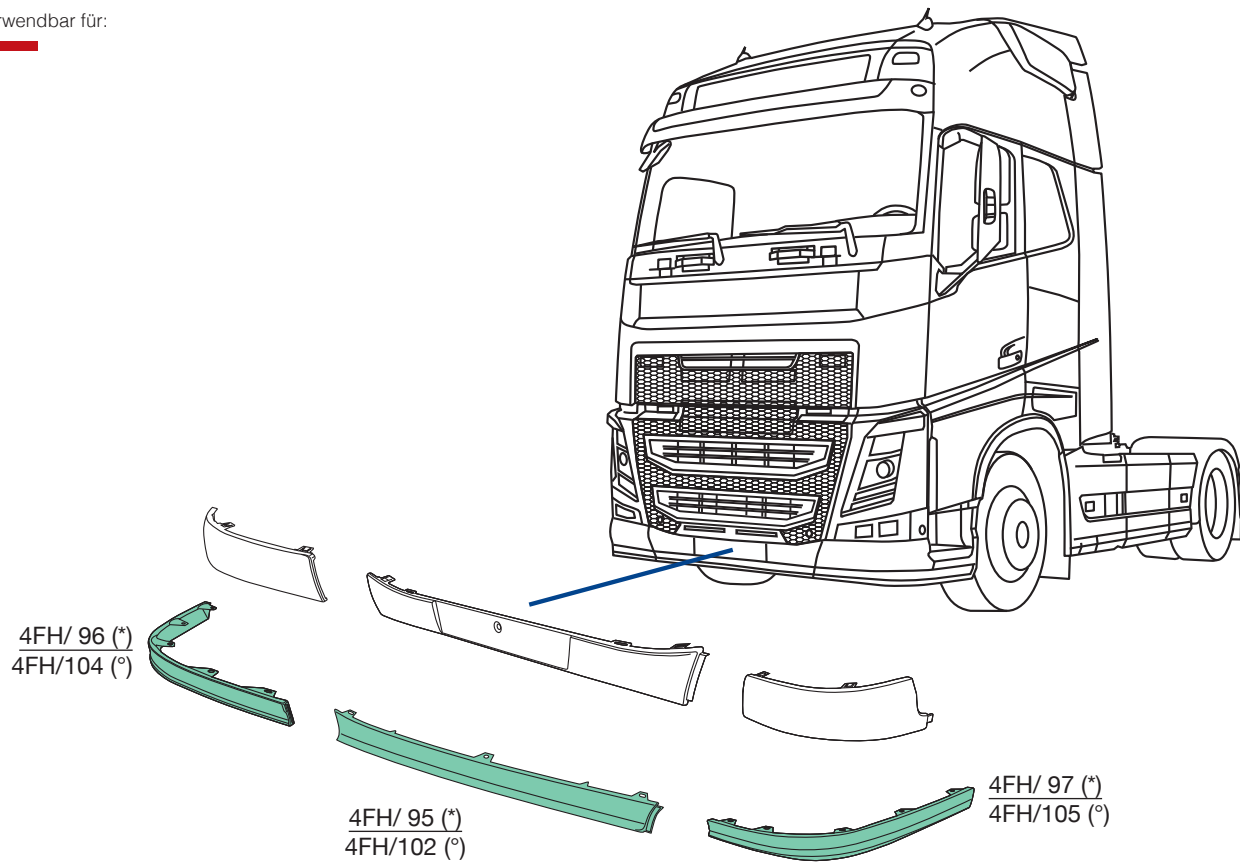

4FH/ 95
O.E.M. 21495267

4FH/ 96
O.E.M. 21495268
4FH/ 97
O.E.M. 21495266

4FH/102
O.E.M. 82101912

4FH/104
O.E.M. 82101914
4FH/105
O.E.M. 82101910

FH Euro 6

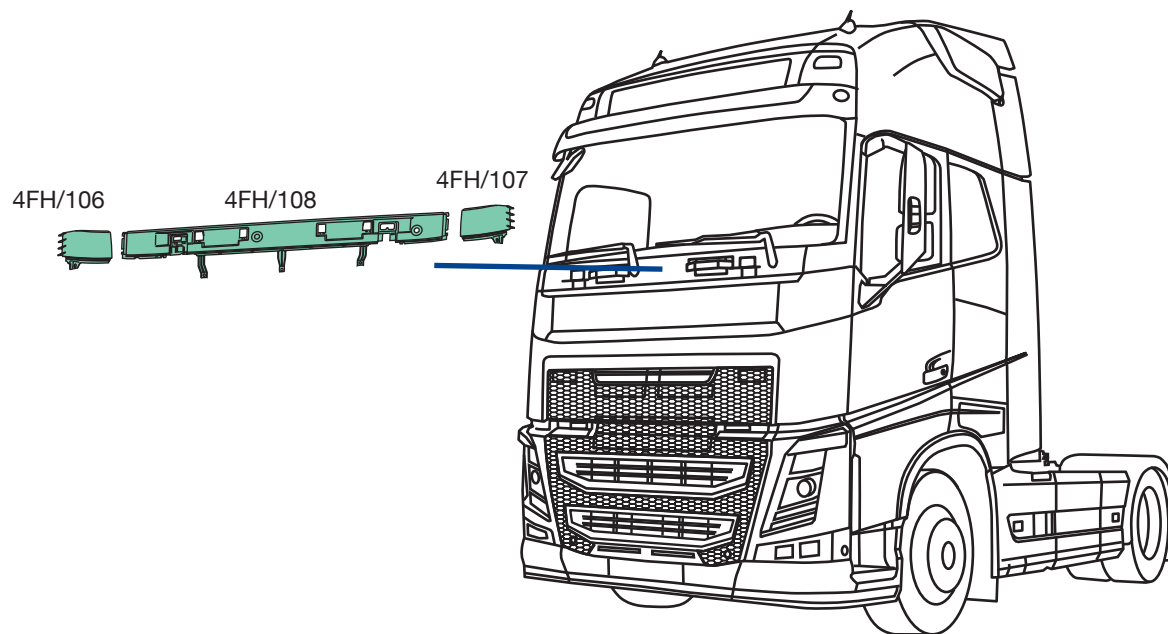

4FH/106
O.E.M. 82835601
4FH/107
O.E.M. 82835554



4FH/108
O.E.M. 84055530

applicabile a | suitable to | verwendbar für:

FH Euro 6

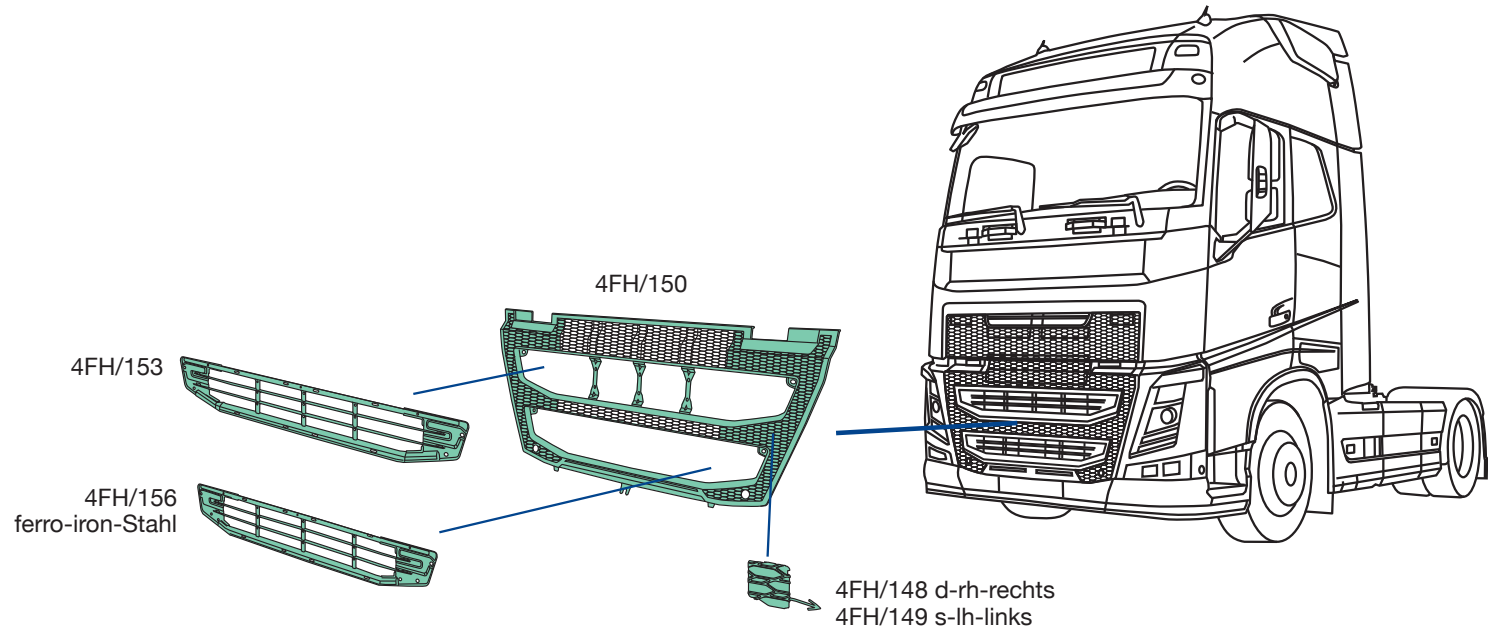

4FH/148
O.E.M. 82187116
4FH/149
O.E.M. 82186579



4FH/150
O.E.M. 82491903



4FH/153
O.E.M. 82258426



4FH/156
O.E.M. 82255346

FH Euro 6

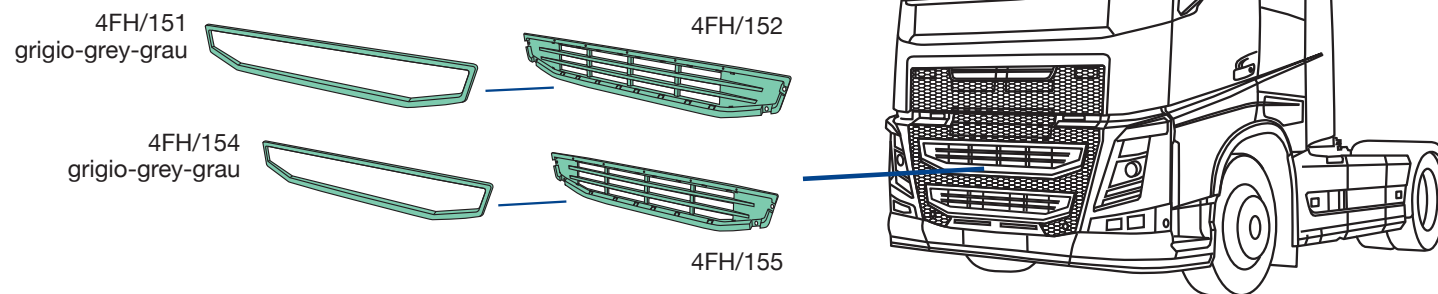

4FH/151
O.E.M. 82180491



4FH/152
O.E.M. 82220161



4FH/154
O.E.M. 82177794



4FH/155
O.E.M. 82220206

applicabile a | suitable to | verwendbar für:

FH Euro 6

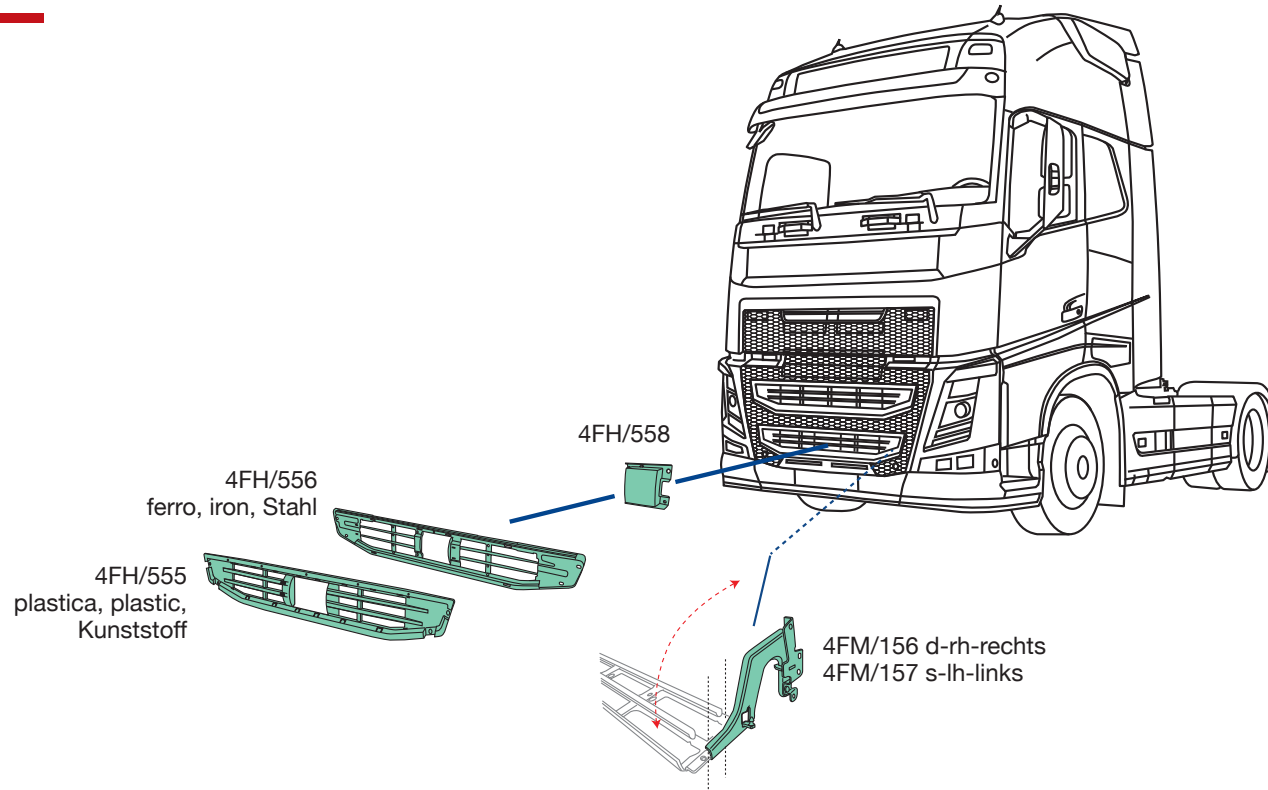

4FH/555
O.E.M. 82298657



4FH/556
O.E.M. 82298483



4FH/558
O.E.M. 84575369



4FM/156
O.E.M. 84104144
4FM/157
O.E.M. 84104142

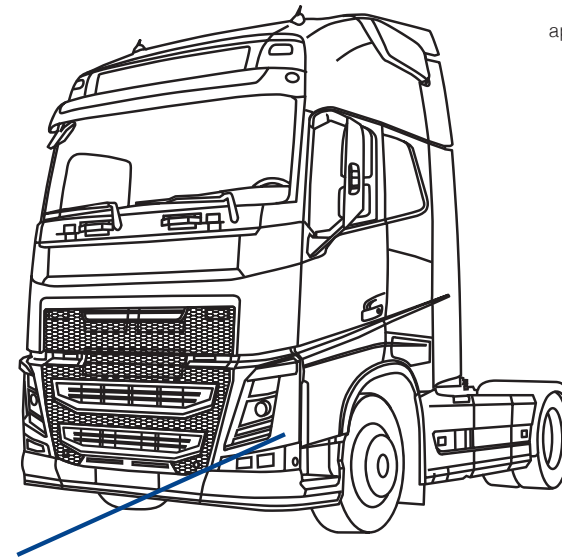

4FH/134 d-rh-rechts
4FH/135 s-lh-links

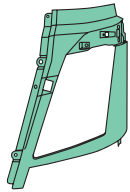

4FH/ 40 d-rh-rechts
4FH/ 41 s-lh-links



4FH/139 d-rh-rechts
4FH/137 s-lh-links



4FH/128 d-rh-rechts
4FH/129 s-lh-links

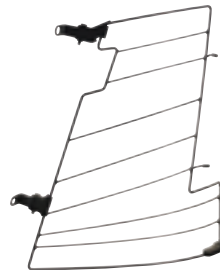

4FH/ 40
O.E.M. 84013223
4FH/ 41
O.E.M. 84013224



4FH/128
O.E.M. 84139933
4FH/129
O.E.M. 84139886



4FH/134
O.E.M. 21874457
4FH/135
O.E.M. 21874450



4FH/139
O.E.M. 82884084
4FH/137
O.E.M. 82884080

applicabile a | suitable to | verwendbar für:

FH Euro 6

4FH/600 d-rh-rechts | 4FH/601 s-lh-links 2013 →



4FH/602 d-rh-rechts | 4FH/603 s-lh-links 2013 →

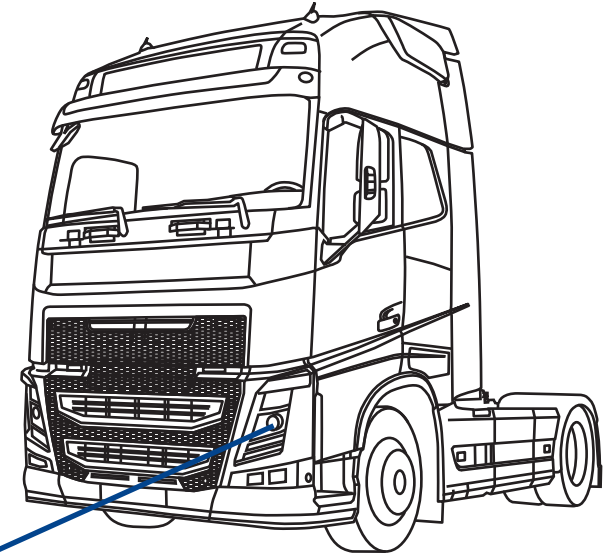
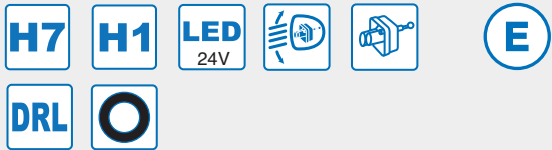

4FH/600 d-rh-rechts
4FH/601 s-lh-links
4FH/602 d-rh-rechts
4FH/603 s-lh-links



9 pins

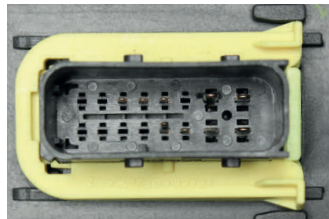

4FH/600
O.E.M. 22239220
4FH/601
O.E.M. 22239221



9 pins

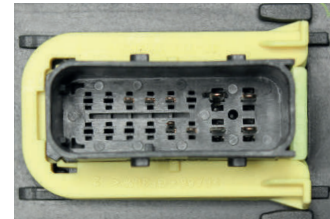

4FH/602
O.E.M. 21608666
4FH/603
O.E.M. 21608667

4FH/604 d-rh-rechts | 4FH/605 s-lh-links 2013 →



4FH/606 d-rh-rechts | 4FH/607 s-lh-links 2013 →



4FH/608 d-rh-rechts | 4FH/609 s-lh-links 2013 →

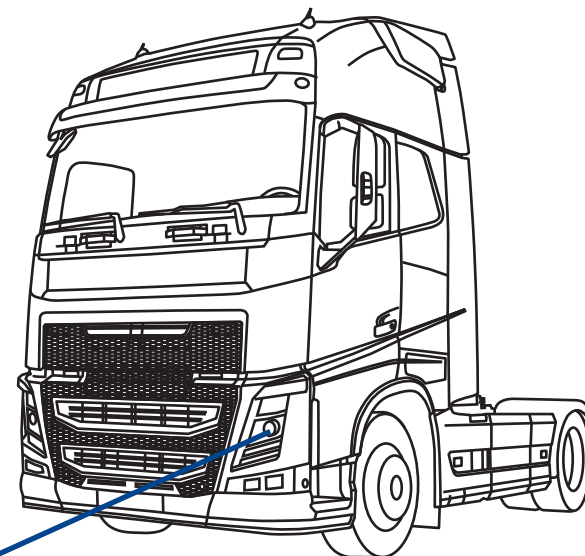
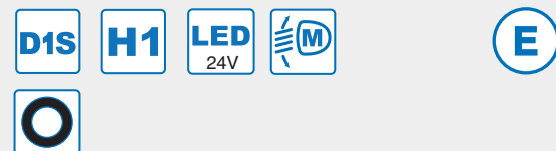

4FH/604 d-rh-rechts
4FH/605 s-lh-links
4FH/606 d-rh-rechts
4FH/607 s-lh-links
4FH/608 d-rh-rechts
4FH/609 s-lh-links



7 pins



7 pins



8 pins



4FH/604
O.E.M. 22239225
4FH/605
O.E.M. 22239226

4FH/606
O.E.M. 22239217
4FH/607
O.E.M. 22239219

4FH/608
O.E.M. 22239248
4FH/609
O.E.M. 22239250

applicabile a | suitable to | verwendbar für:

FH Euro 6

4FH/136 d-rh-rechts | 4FH/138 s-lh-links 2013 →

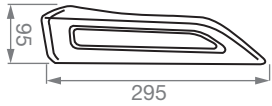

4FH/426 d-rh-rechts | 4FH/427 s-lh-links 2013 →

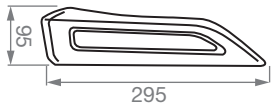

4FH/131 d-rh-rechts
4FH/132 s-lh-links

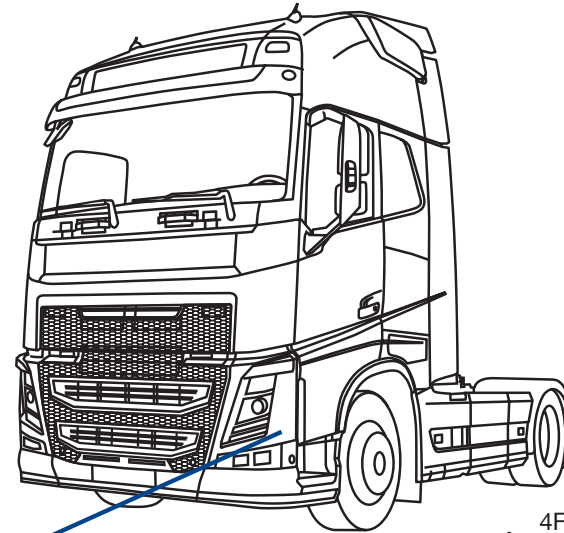
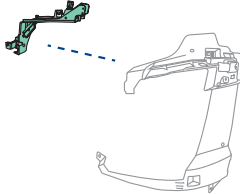

4FH/124 d-rh-rechts
4FH/125 s-lh-links

4FH/126 d-rh-rechts
4FH/127 s-lh-links

4FH/136 d-rh-rechts
4FH/138 s-lh-links
4FH/426 d-rh-rechts
4FH/427 s-lh-links



4FH/124
O.E.M. 82453926
4FH/125
O.E.M. 82446592

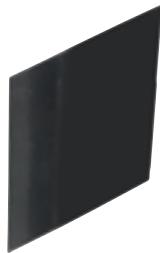

4FH/126
O.E.M. 21413774
4FH/127
O.E.M. 21413734



4FH/131
O.E.M. 84058023
4FH/132
O.E.M. 84046776



4FH/136
O.E.M. 23386781
4FH/138
O.E.M. 23386782



4FH/426
O.E.M. 21346522
4FH/427
O.E.M. 21346521

4FH/700 d-rh-rechts | 4FH/701 s-lh-links 2013 →

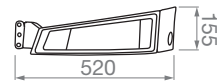

4FH/702 d-rh-rechts | 4FH/703 s-lh-links 2013 →



CON LUCE DI PROFONDITÀ
WITH HIGH BEAM
MIT FERNLICHT

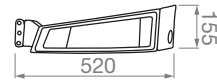

4FH/704 d-rh-rechts | 4FH/705 s-lh-links 2013 →



CON LUCE DI PROFONDITÀ
WITH HIGH BEAM
MIT FERNLICHT

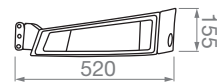

4FH/706 d-rh-rechts | 4FH/707 s-lh-links 2013 →



CON CURVA DINAMICA
WITH BEND LIGHT
MIT KURVENLICHT

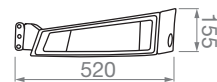

4FH/708 d-rh-rechts | 4FH/709 s-lh-links 2013 →

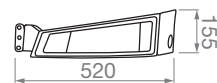

4FH/700 d-rh-rechts
4FH/701 s-lh-links
4FH/702 d-rh-rechts
4FH/703 s-lh-links
4FH/704 d-rh-rechts
4FH/705 s-lh-links
4FH/706 d-rh-rechts
4FH/707 s-lh-links
4FH/708 d-rh-rechts
4FH/709 s-lh-links

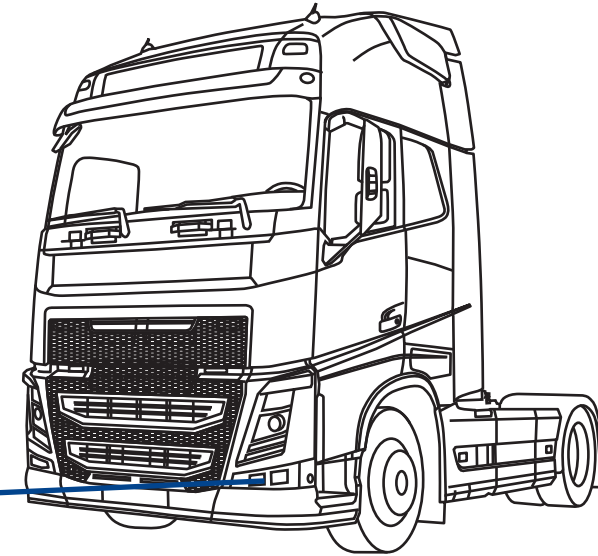

4FH/700
O.E.M. 22332596
4FH/701
O.E.M. 22332597

4FH/702
O.E.M. 22332594
4FH/703
O.E.M. 22332595

4FH/704
O.E.M. 22332598
4FH/705
O.E.M. 22332600

4FH/706
O.E.M. 22332603
4FH/707
O.E.M. 22332604

4FH/708
O.E.M. 22332592
4FH/709
O.E.M. 22332593

applicabile a | suitable to | verwendbar für:

FH Euro 6

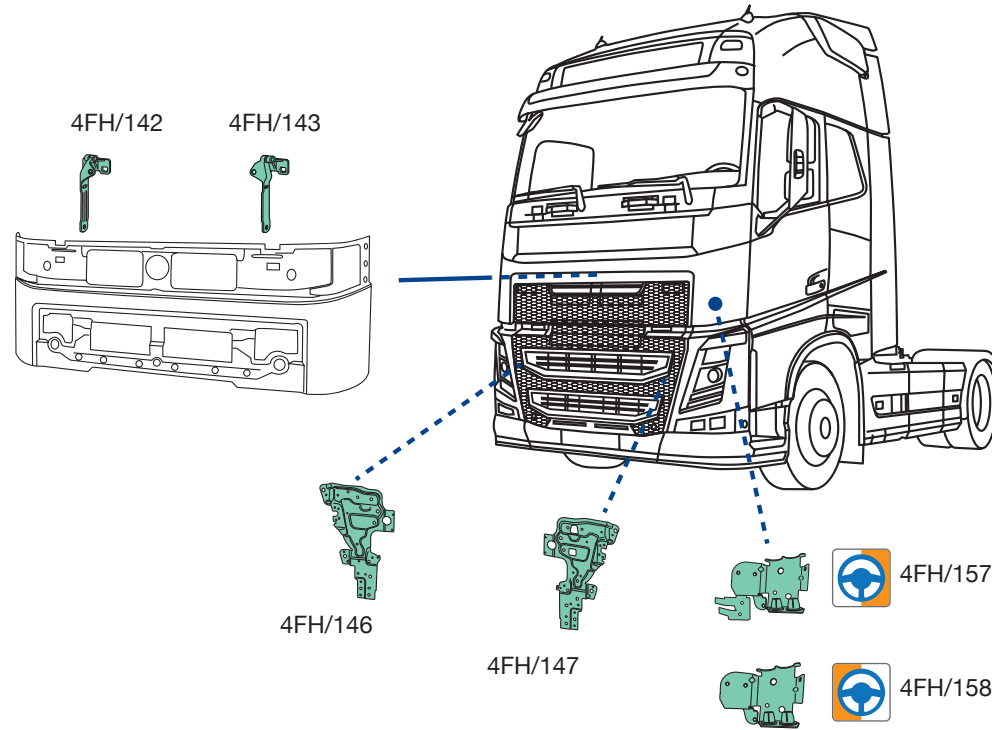

4FH/142
O.E.M. 82320177
4FH/143
O.E.M. 82320176



4FH/146
O.E.M. 84228541



4FH/147
O.E.M. 84228539



4FH/157
O.E.M. 82857758



4FH/158
O.E.M. 82857748

FH Euro 6

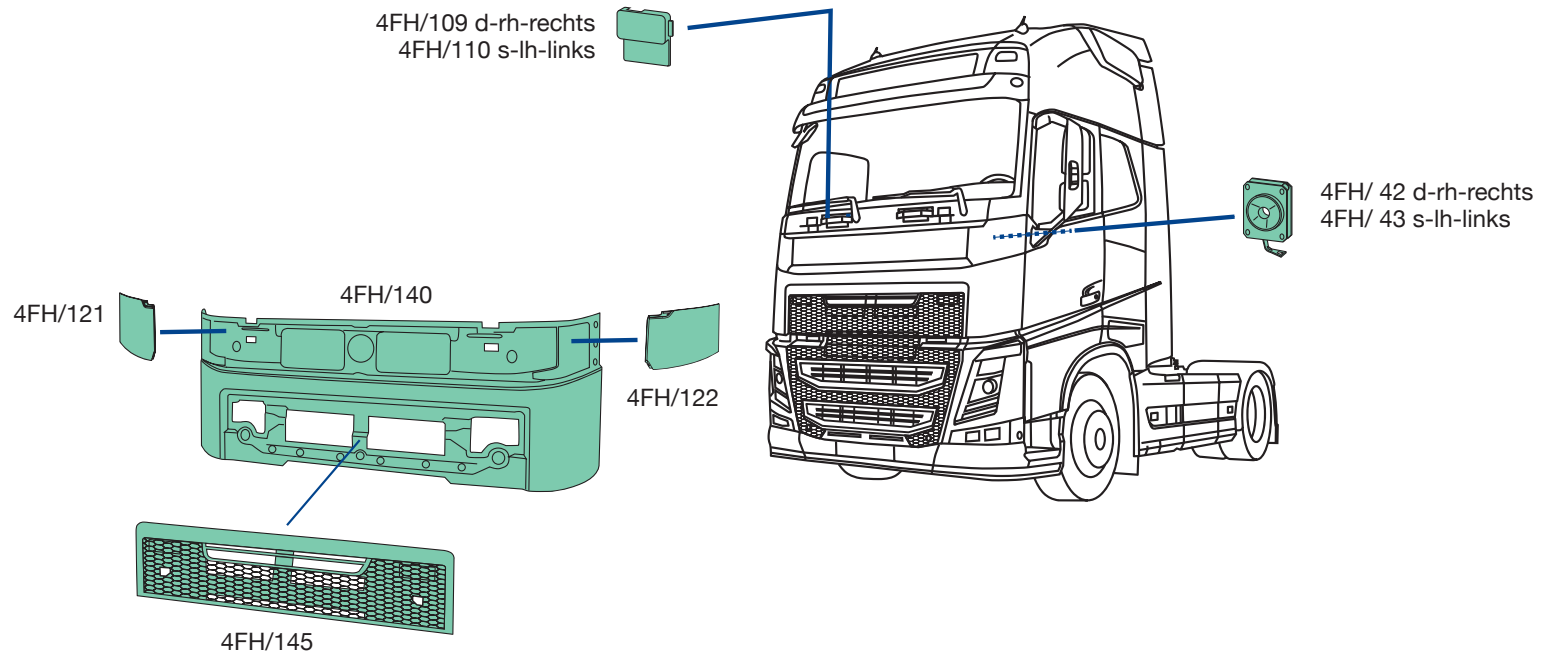

4FH/ 42
O.E.M. 82213089
4FH/ 43
O.E.M. 82232959



4FH/109
O.E.M. 82846116
4FH/110
O.E.M. 82846118



4FH/121
O.E.M. 23462387
4FH/122
O.E.M. 23462398



4FH/140
O.E.M. 82360122



4FH/145
O.E.M. 84033228

applicabile a | suitable to | verwendbar für:

FH Euro 6



4FH/410 84014254
82131055

materiale | material | material PMMA - Acrylglas

peso | weight | Gewicht 3,690 Kg

applicabilità | suitable to | für VOLVO 4FH. FH euro 6

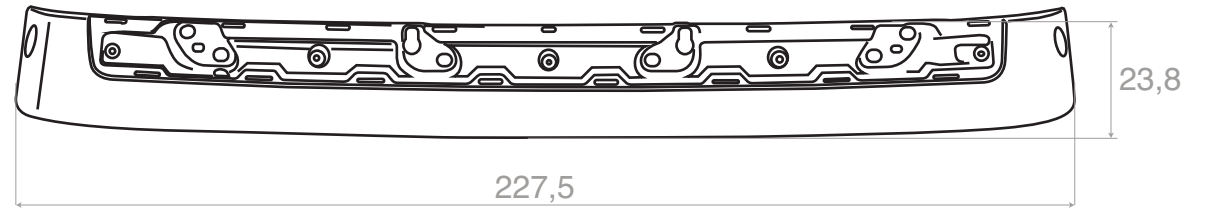

(cm)

extra



4FH/400 82166469



COVIND

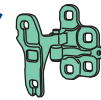
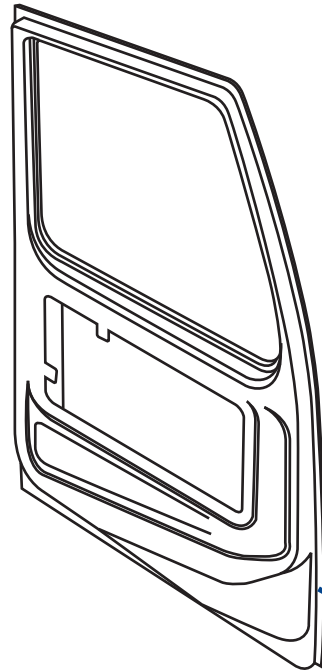

4FH/ 8 d-rh-rechts
4FH/ 9 s-lh-links



4FH/ 8
O.E.M. 23311948
4FH/ 9
O.E.M. 23311945

applicabile a | suitable to | verwendbar für:

FH Euro 6

4FH/506

84167321
(82110547)
(84004929)

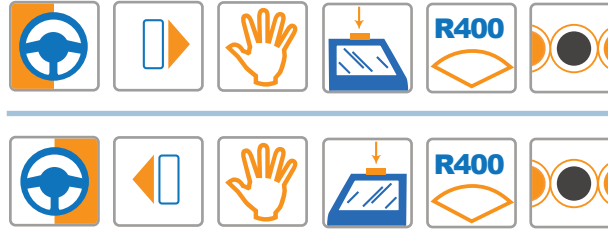

V E9 0411660
295x180 mm

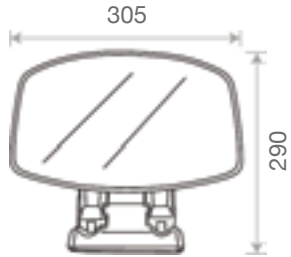

applicabilità:
applicable to:
Verwendbar für

VOLVO 4FH. FH euro 6



(*) liscio-smooth-glatt
 (°) goffrato-textured-Geprägte

applicabile a | suitable to | verwendbar für:

FH Euro 6

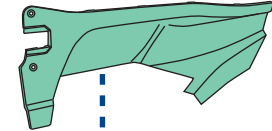
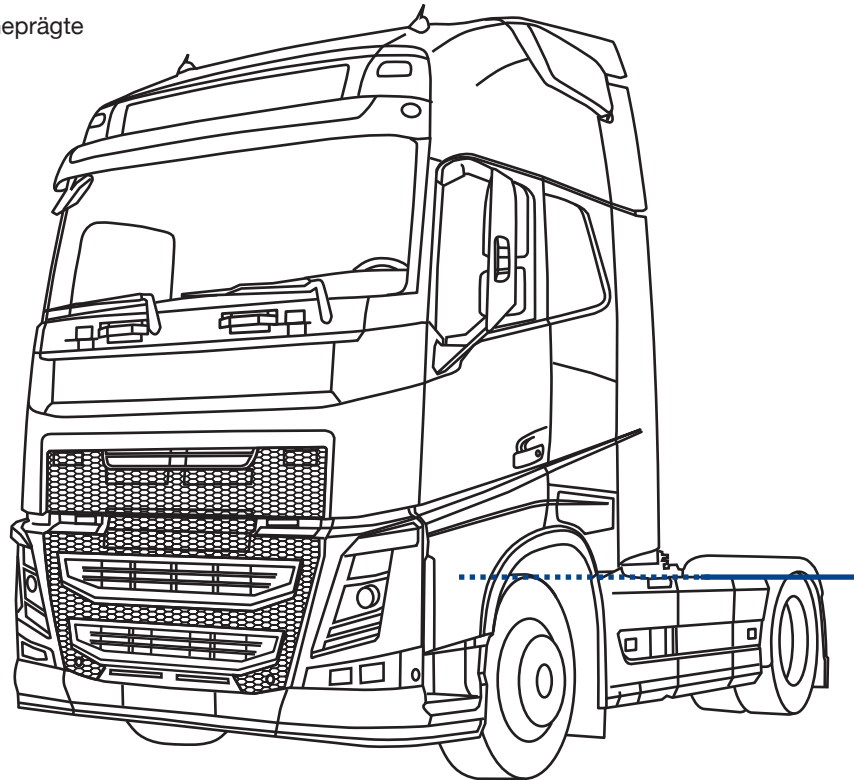

4FH/204 d-rh-rechts
 4FH/205 s-lh-links

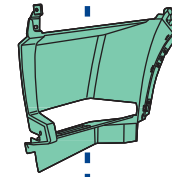

4FH/244 d-rh-rechts
 4FH/245 s-lh-links

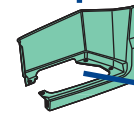

4FH/240(°) d-rh-rechts
 4FH/241(°) s-lh-links
 4FH/242(*) d-rh-rechts
 4FH/243(*) s-lh-links

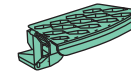

4FH/208 d-rh-rechts
 4FH/209 s-lh-links



4FH/204
 O.E.M. 82819477
4FH/205
 O.E.M. 82819482



4FH/208
 O.E.M. 82859306
4FH/209
 O.E.M. 82171603



4FH/240
 O.E.M. 82142373
4FH/241
 O.E.M. 82141971



4FH/242
 O.E.M. 21392187
4FH/243
 O.E.M. 21392183



4FH/244
 O.E.M. 82141521
4FH/245
 O.E.M. 82136982

applicabile a | suitable to | verwendbar für:

FH Euro 6

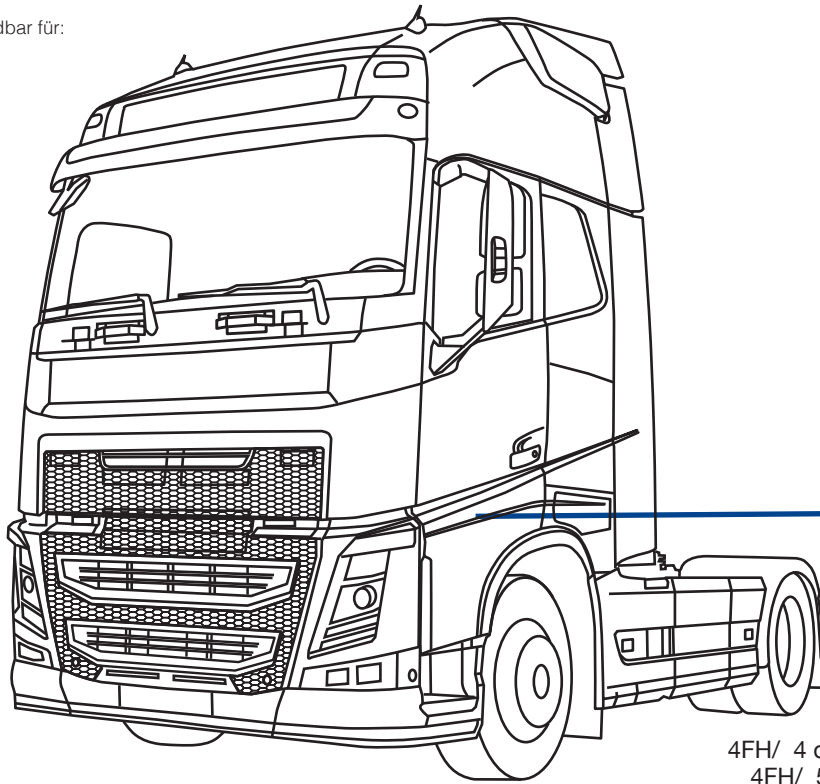

4FH/ 4 d-rh-rechts
4FH/ 5 s-lh-links
alluminio, nero
aluminium, black

4FH/250 d-rh-rechts
4FH/251 s-lh-links

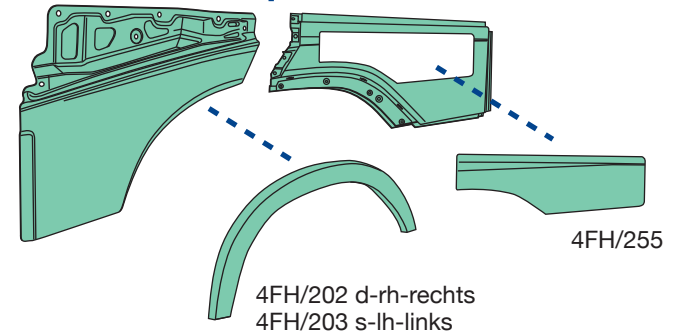

4FH/ 4
O.E.M. 21642399
4FH/ 5
O.E.M. 21642377



4FH/202
O.E.M. 84096589
4FH/203
O.E.M. 84096588



4FH/250
O.E.M. 84233571



4FH/251
O.E.M. 21940892



4FH/255
O.E.M. 21413732

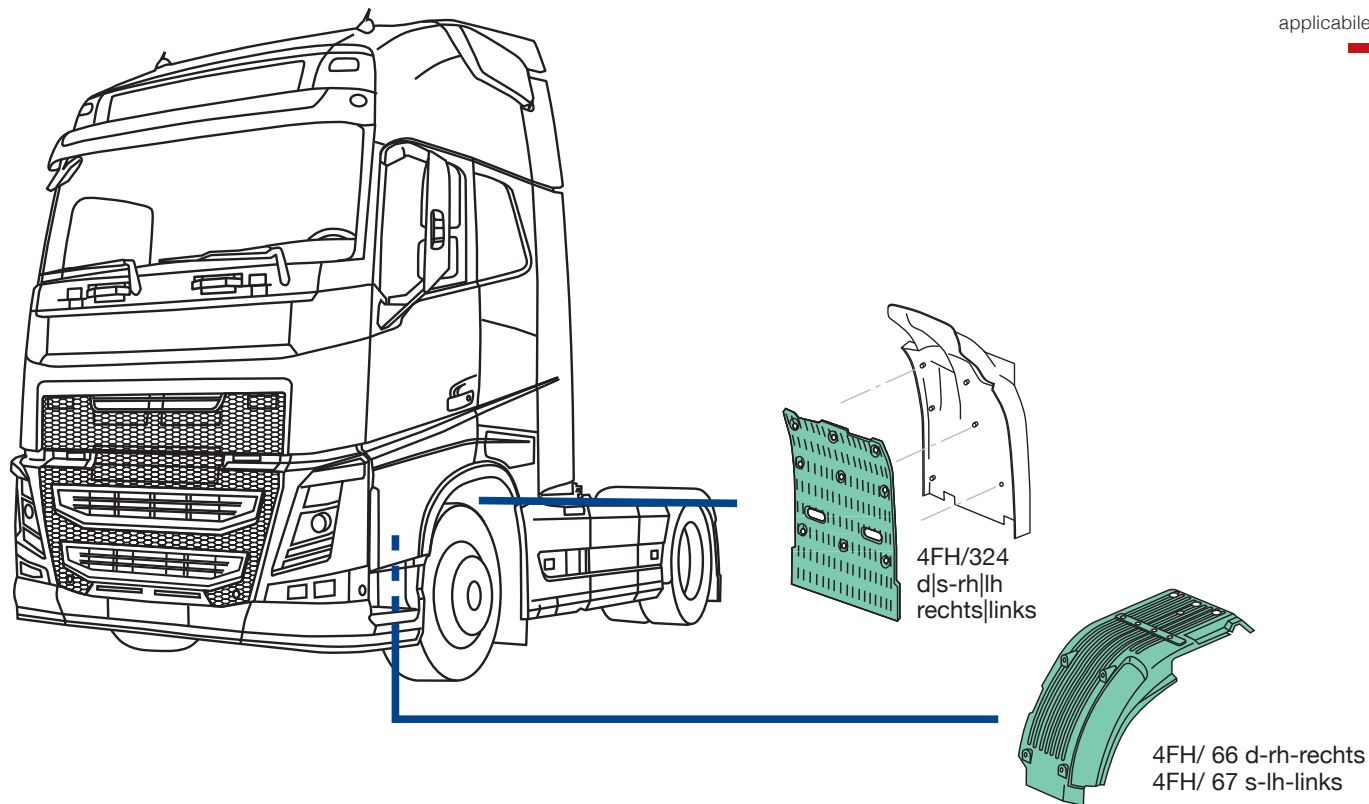

4FH/324
O.E.M. 84106936



4FH/ 66
O.E.M. 82141524
4FH/ 67
O.E.M. 82110404

FH Euro 6

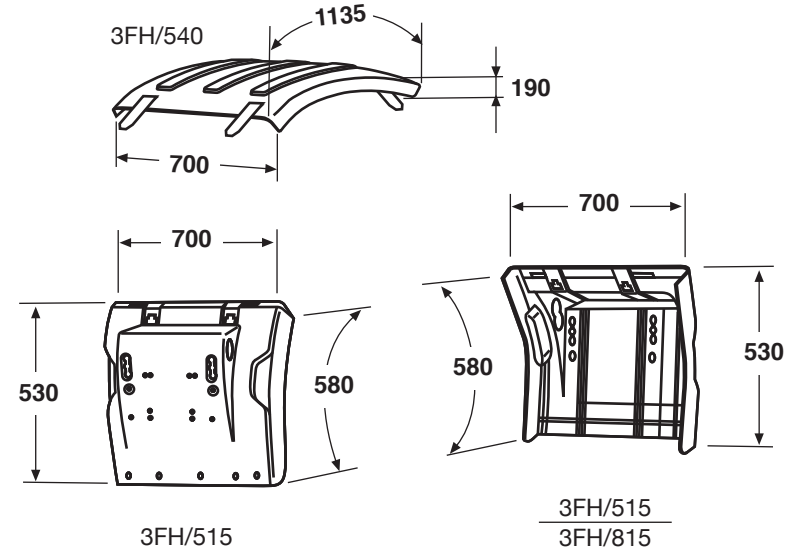
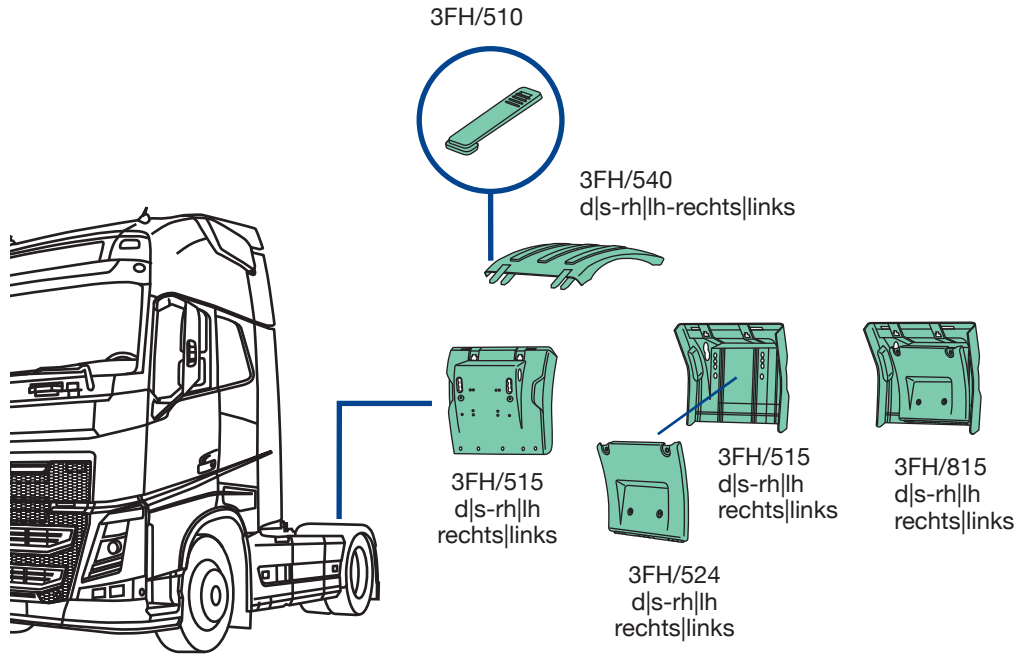

3FH/510
O.E.M. 21094457



3FH/524
O.E.M. 21094447

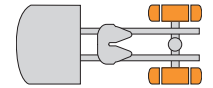

3FH/540
O.E.M. 21094390
d|s-rh|lh-rechts|links
nero, semipiatta,
con cinghietti
black, semi-flat,
with stretchers
schwarz, halbflach,
mit Spanngummi

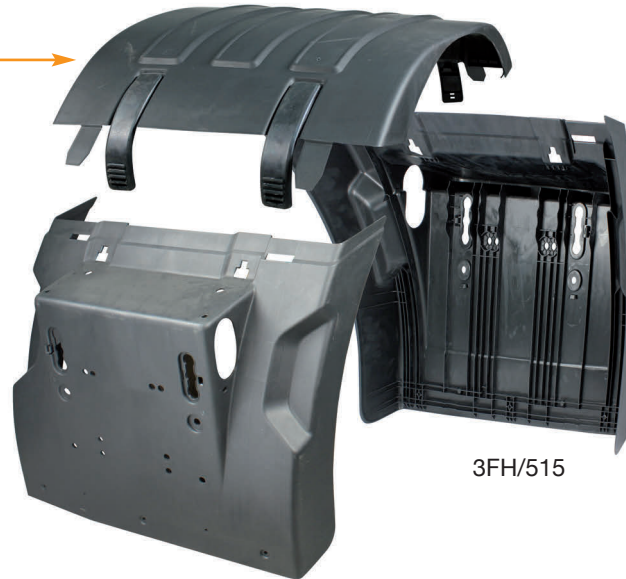

3FH/515
O.E.M. 21094391
d|s-rh|lh-rechts|links
nero-black-schwarz

3FH/515

3FH/815
O.E.M. -
d|s-rh|lh-rechts|links
nero-black-schwarz



3FH/815 O.E.M. -

**KIT
Satz**



A

B

C

D

E

F

G

H

i

3FH/515
O.E.M. 21094391
1 pz.-pcs.-Stk.

3FH/524
O.E.M. 21094447
1 pz.-pcs.-Stk.

3FH/526
O.E.M. 21094456 +
21094454
2 pz.-pcs.-Stk.

-
O.E.M. 21094449
1 pz.-pcs.-Stk.

-
O.E.M. 21094453
2 pz.-pcs.-Stk.

-
O.E.M. 21094451
6 pz.-pcs.-Stk.

-
O.E.M. 992426
2 pz.-pcs.-Stk.

-
O.E.M. 992423
6 pz.-pcs.-Stk.

-
O.E.M. 60112154
2 pz.-pcs.-Stk.

FH Euro 6

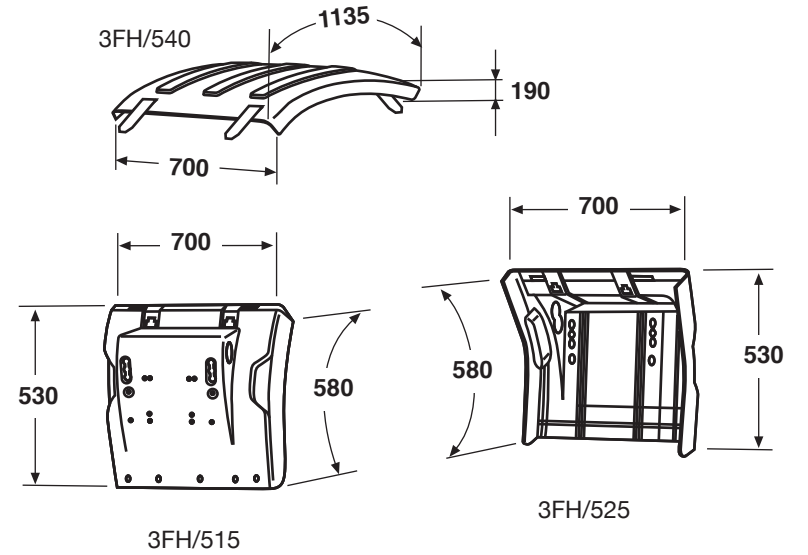
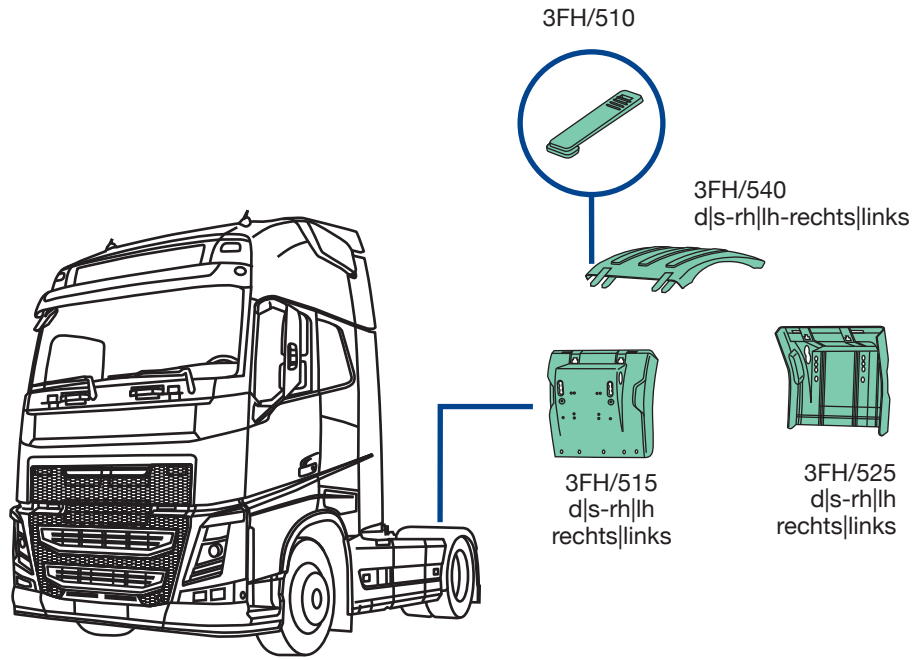

3FH/510
O.E.M. 21094457

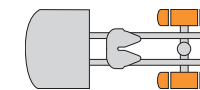

3FH/540
 O.E.M. 21094390
 d|s-rh|lh-rechts|links
 nero, semipiatta, con cinghietti
 black, semi-flat, with stretchers
 schwarz, halbflach, mit Spanngummi



3FH/515
 O.E.M. 21094391
 d|s-rh|lh-rechts|links
 nero-black-schwarz

3FH/525
 O.E.M. 21094394
 d|s-rh|lh-rechts|links
 nero, senza anti-spray
 black, without anti-spray
 schwarz, ohne Spritzschutz



FH Euro 6

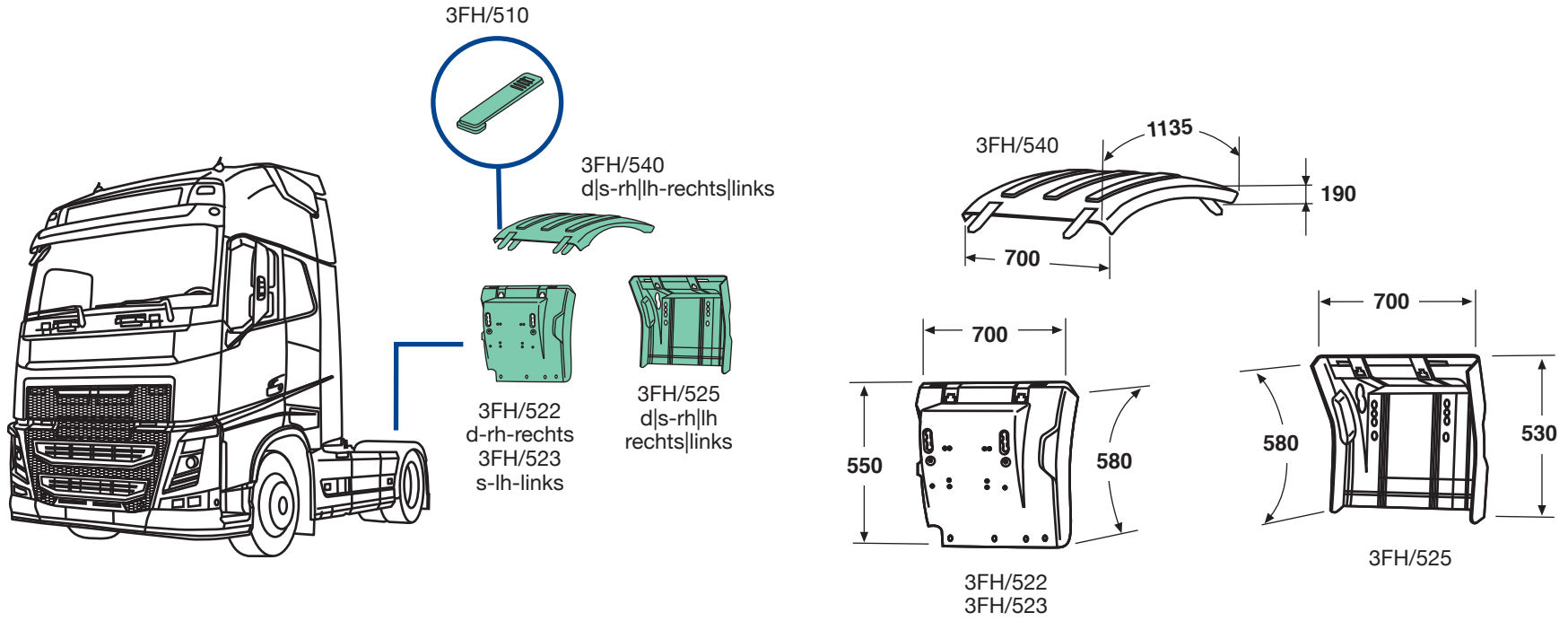

3FH/510
O.E.M. 21094457

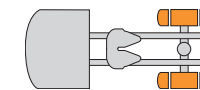

3FH/540
 O.E.M. 21094390
 d|s-rh||h-rechts|links
 nero, semipiatta, con cinghietti
 black, semi-flat, with stretchers
 schwarz, halbflach, mit Spanngummi

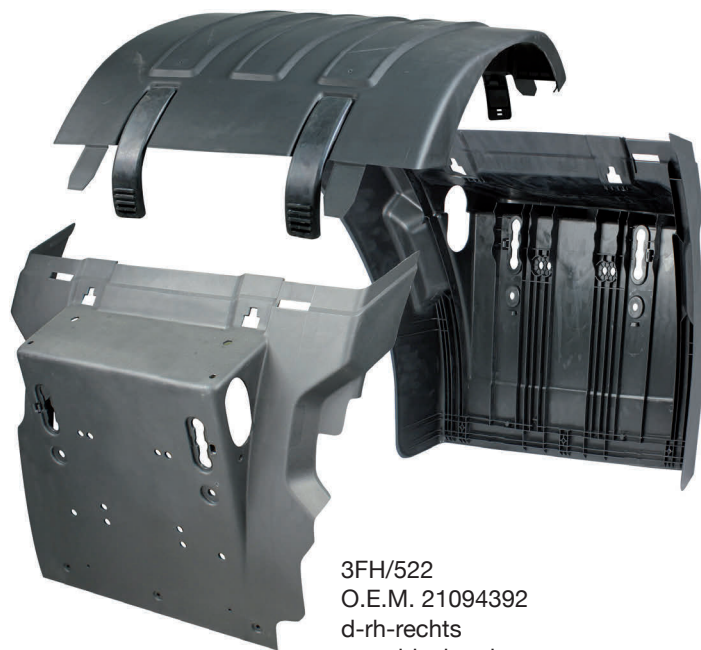

3FH/522
 O.E.M. 21094392
 d-rh-rechts
 nero-black-schwarz

3FH/525
 O.E.M. 21094394
 d|s-rh||h-rechts|links
 nero, senza anti-spray
 black, without anti-spray
 schwarz, ohne Spritzschutz



3FH/540

3FH/525

3FH/523
 O.E.M. 21094393
 s-lh-links
 nero-black-schwarz

applicabile a | suitable to | verwendbar für:

FH Euro 6

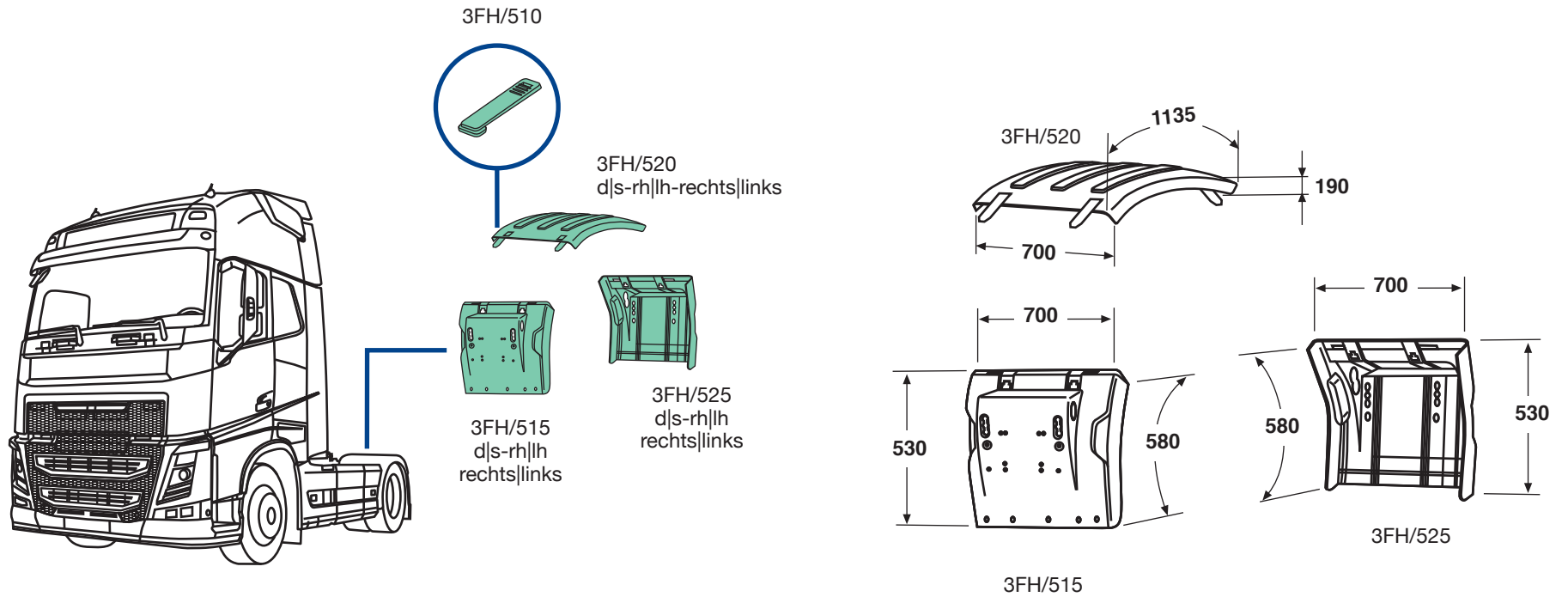

3FH/510
O.E.M. 21094457

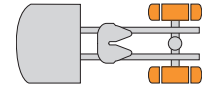

3FH/520
 O.E.M. 21094388
 d|s-rh|lh-rechts|links
 nero, semipiatta, con cinghietti
 black, semi-flat, with stretchers
 schwarz, halbflach, mit Spanngummi



3FH/515
 O.E.M. 21094391
 d|s-rh|lh-rechts|links
 nero-black-schwarz

3FH/525
 O.E.M. 21094394
 d|s-rh|lh-rechts|links
 nero, senza anti-spray
 black, without anti-spray
 schwarz, ohne Spritzschutz



FH Euro 6

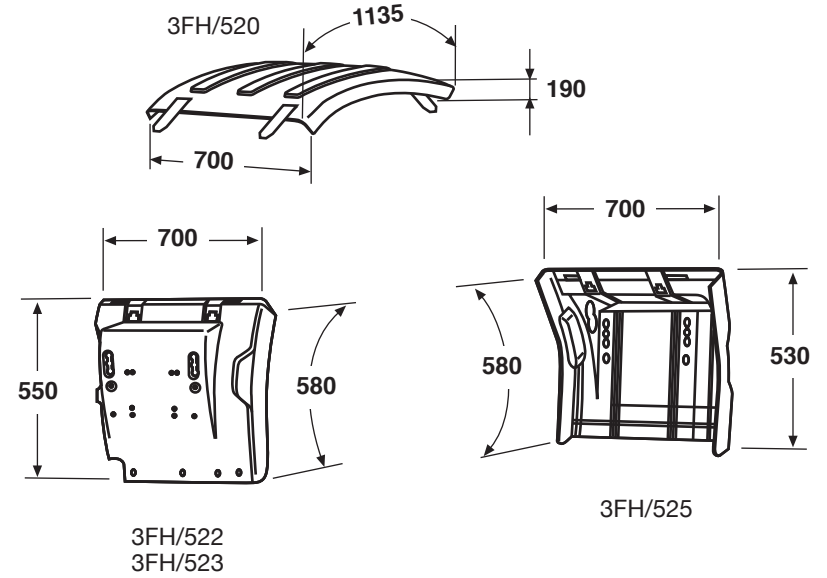
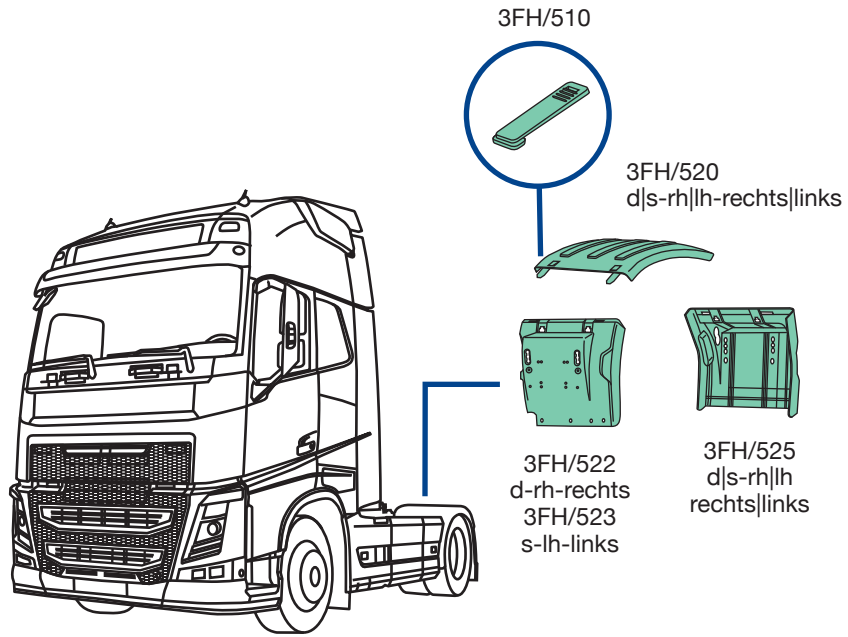

3FH/510
O.E.M. 21094457

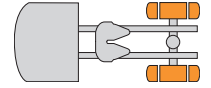

3FH/520
 O.E.M. 21094388
 d|s-rh|lh-rechts|links
 nero, semipiatta, con cinghietti
 black, semi-flat, with stretchers
 schwarz, halbflach, mit Spanngummi



3FH/525
 O.E.M. 21094394
 d|s-rh|lh-rechts|links
 nero, senza anti-spray
 black, without anti-spray
 schwarz, ohne Spritzschutz



3FH/520



3FH/525

3FH/522
 O.E.M. 21094392
 d-rh-rechts
 nero-black-schwarz

3FH/523
 O.E.M. 21094393
 s-lh-links
 nero-black-schwarz

FH Euro 6

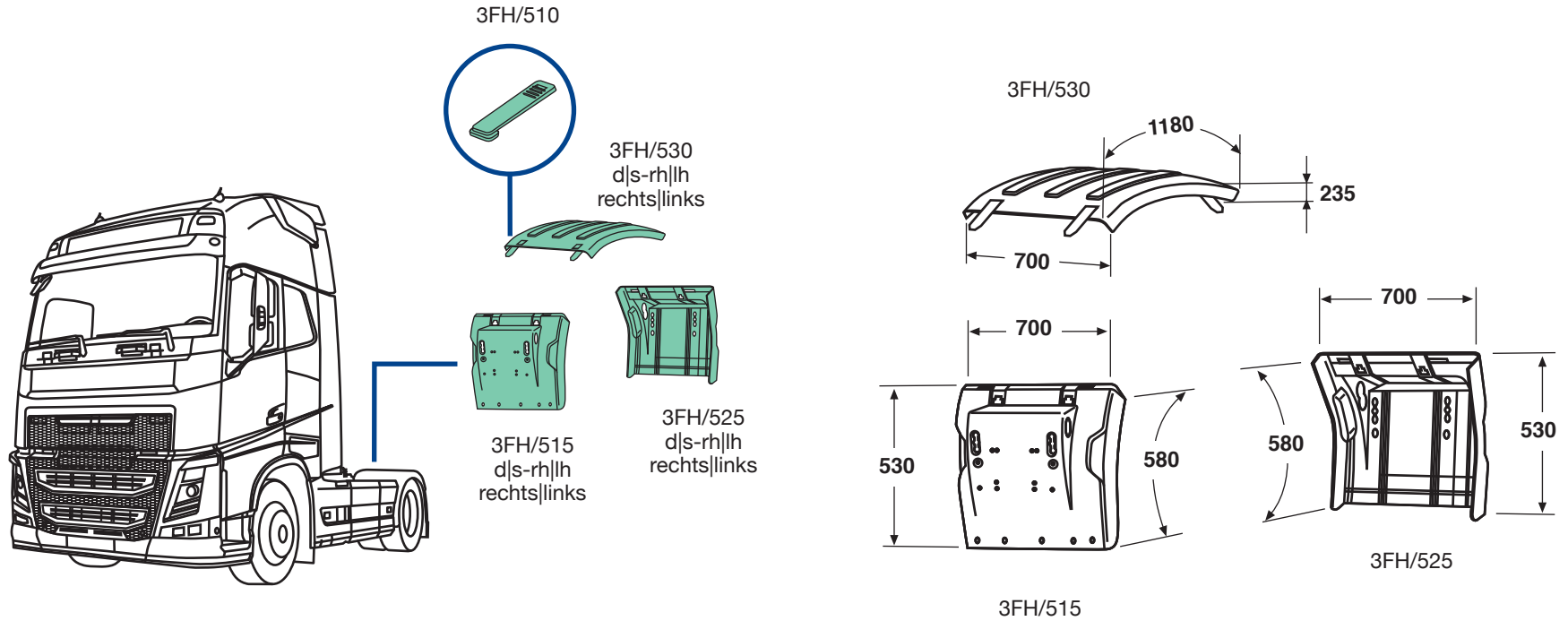

3FH/510
O.E.M. 21094457

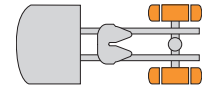

3FH/530
 O.E.M. 21094383
 d|s-rh|lh-rechts|links
 nero, circolare, senza cinghietti
 black, circular, without stretchers
 schwarz, kreisförmig, ohne Spanngummi



3FH/515
 O.E.M. 21094391
 d|s-rh|lh-rechts|links
 nero-black-schwarz

3FH/525
 O.E.M. 21094394
 d|s-rh|lh-rechts|links
 nero, senza anti-spray
 black, without anti-spray
 schwarz, ohne Spritzschutz



FH Euro 6

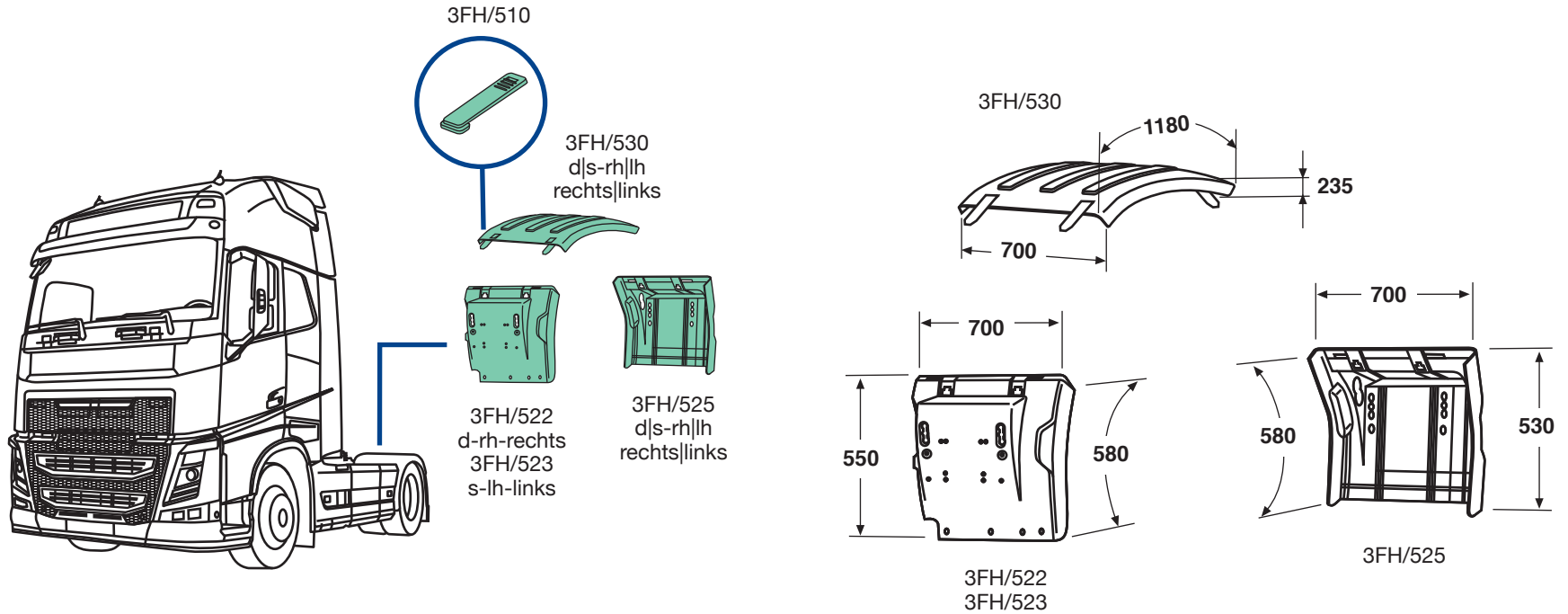

3FH/510
O.E.M. 21094457

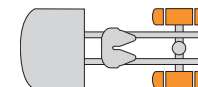

3FH/530
 O.E.M. 21094383
 d|s-rh|lh-rechts|links
 nero, circolare, senza cinghietti
 black, circular, without stretchers
 schwarz, kreisförmig, ohne Spanngummi

3FH/525
 O.E.M. 21094394
 d|s-rh|lh-rechts|links
 nero, senza anti-spray
 black, without anti-spray
 schwarz, ohne Spritzschutz



3FH/522
 O.E.M. 21094392
 d-rh-rechts
 nero-black-schwarz



3FH/523
 O.E.M. 21094393
 s-lh-links
 nero-black-schwarz

3FH/525

FH Euro 6

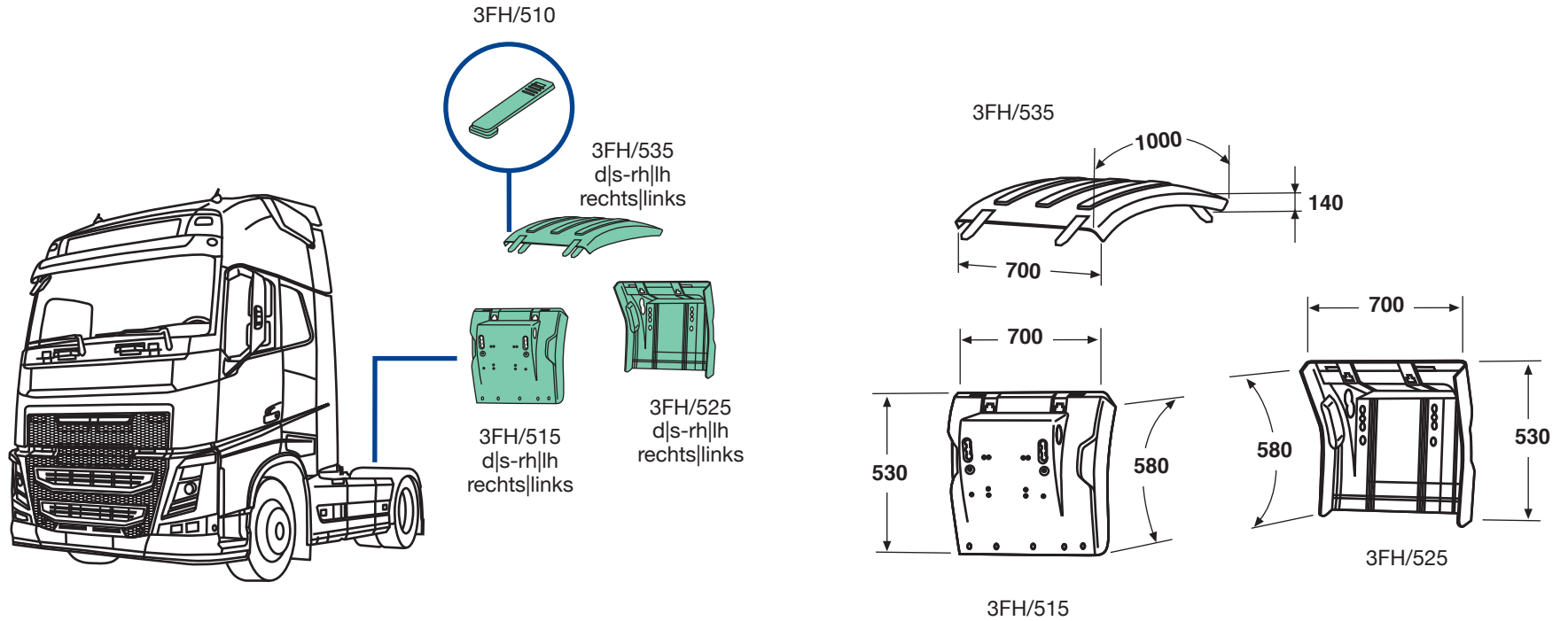

3FH/510
O.E.M. 21094457

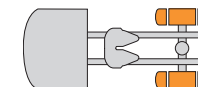

3FH/535
 O.E.M. 21094389
 d|s-rh|lh-rechts|links
 nero, piatta, con cinghietti
 black, flat, with stretchers
 schwarz, flach, mit Spanngummi



3FH/515
 O.E.M. 21094391
 d|s-rh|lh-rechts|links
 nero-black-schwarz

3FH/525
 O.E.M. 21094394
 d|s-rh|lh-rechts|links
 nero, senza anti-spray
 black, without anti-spray
 schwarz, ohne Spritzschutz



FH Euro 6

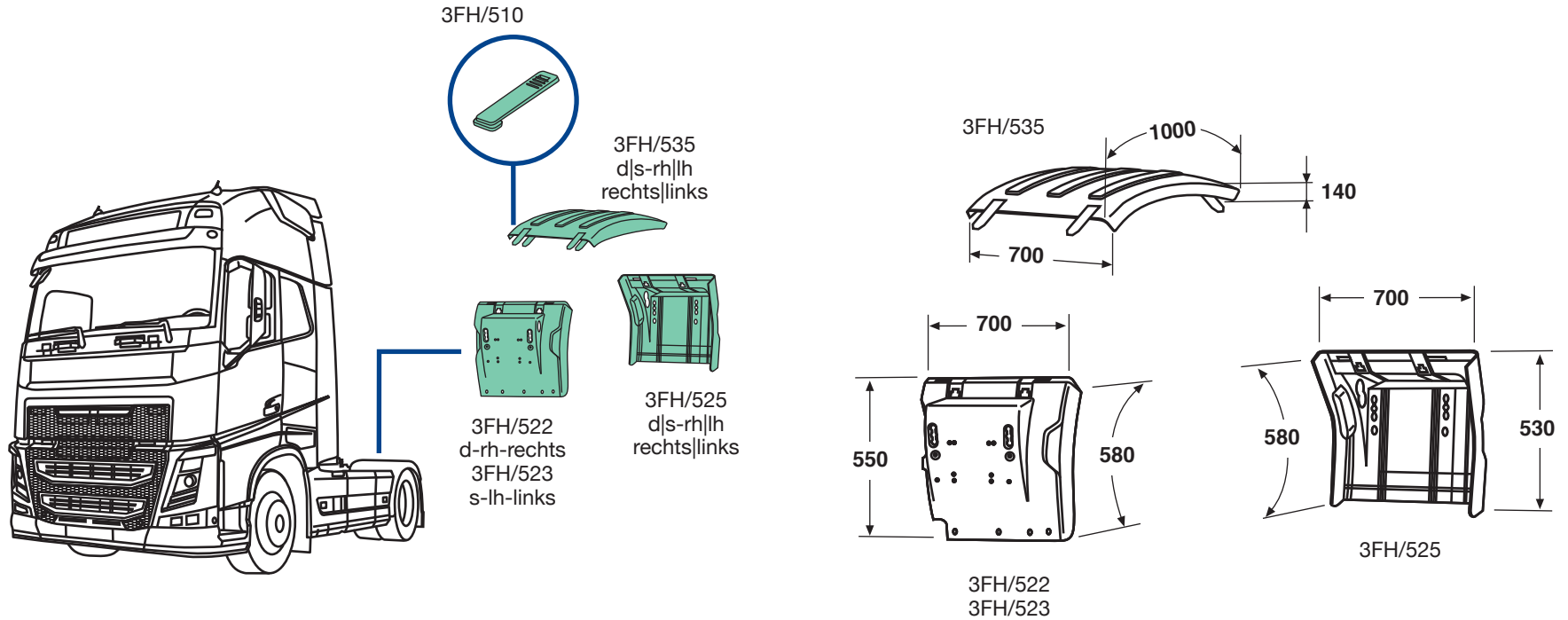

3FH/510
O.E.M. 21094457

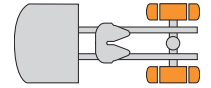

3FH/535
 O.E.M. 21094389
 d|s-rh|lh-rechts|links
 nero, piatta, con cinghietti
 black, flat, with stretchers
 schwarz, flach, mit Spanngummi



3FH/525
 O.E.M. 21094394
 d|s-rh|lh-rechts|links
 nero, senza anti-spray
 black, without anti-spray
 schwarz, ohne Spritzschutz



3FH/522
 O.E.M. 21094392
 d-rh-rechts
 nero-black-schwarz

3FH/535



3FH/525

3FH/523
 O.E.M. 21094393
 s-lh-links
 nero-black-schwarz

FH Euro 6

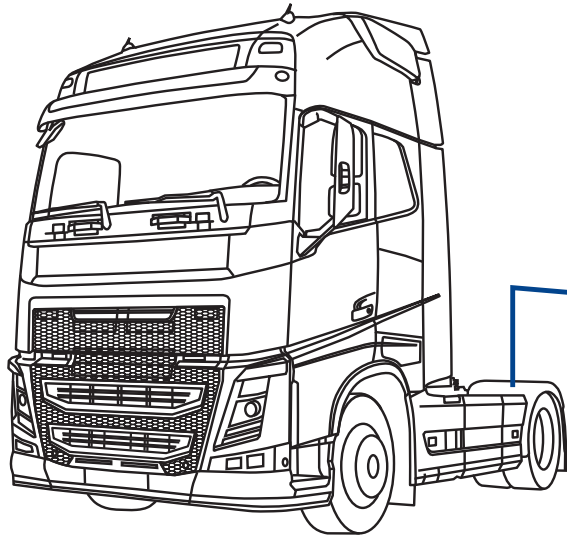

2FH/528
d|s-rh|lh
rechts|links

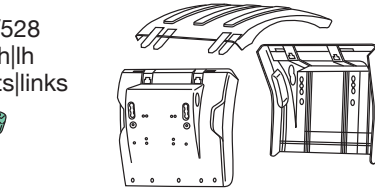

2FH/526
d|s-rh|lh
rechts|links

2FH/528
d|s-rh|lh
rechts|links



2FH/526
d|s-rh|lh
rechts|links



2FH/526
O.E.M. 21213202



2FH/528
O.E.M. 21090272

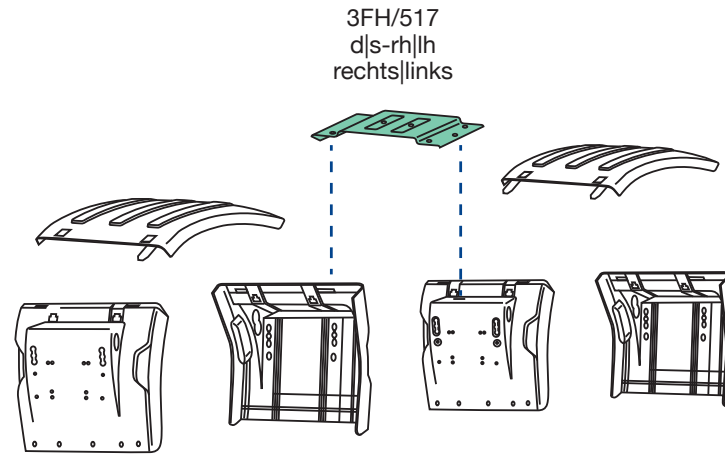

3FH/517
O.E.M. 21094406

applicabile a | suitable to | verwendbar für:

FH Euro 6

RRT/632 d-rh-rechts | RRT/631 s-lh-links

LED	↔	☾	STOP	⚡	⚡	⚡	E
○	●						



AMP 7 PIN

LATERALE
LATERAL
SEITLICH

RRT/630 d-rh-rechts

LED	↔	☾	STOP	⚡	⚡	⚡	E
○	●	CON CICALINO RETROMARCIA WITH BACK-UP ALARM AKUSTISCHE WARNVORRICHTUNG					



AMP 7 PIN

LATERALE
LATERAL
SEITLICH

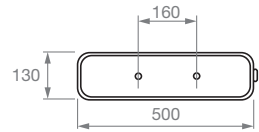

RRT/645 d-s|rh-lh|rechts-links

○	●	E
---	---	---

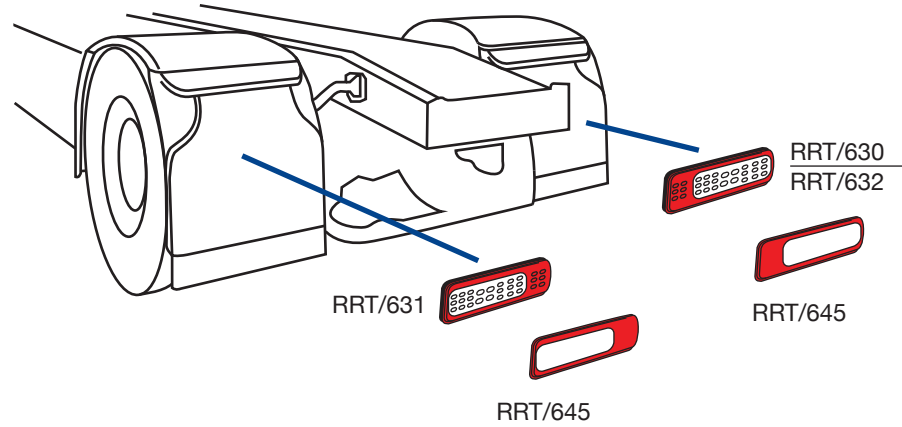

RRT/630
O.E.M. 23354973



RRT/631
O.E.M. 23354974
RRT/632
O.E.M. 23354972



RRT/645
O.E.M. 82849905

FH Euro 6

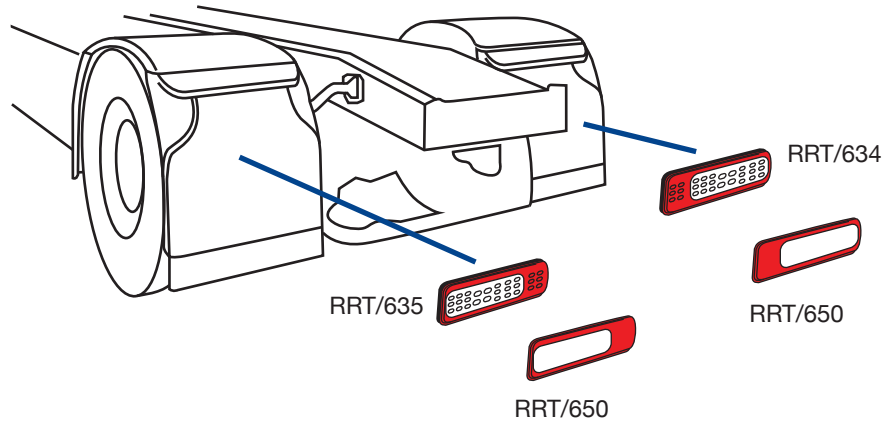

RRT/634 (*) d-rh-rechts | RRT/635 (*) s-lh-links

LED	↔	☾☽	STOP	⚡	Ⓜ	🔲	Ⓜ
⊙	●	(*) CON CICALINO RETROMARCIA WITH BACK-UP ALARM AKUSTISCHE WARNVORRICHTUNG		(*) CON LUCE TARGA WITH NUMBER PLATE LAMP KENNZEICHENLEUCHTE			

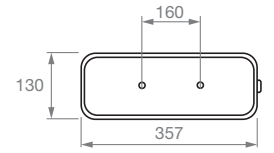

RRT/650 d-s|rh-lh|rechts-links

⊙	●	Ⓜ
---	---	---



RRT/634
O.E.M. 23522308
RRT/635
O.E.M. 23522307



RRT/650
O.E.M. 84122332

applicabile a | suitable to | verwendbar für:

FH Euro 6

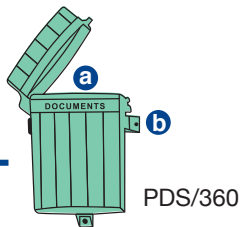
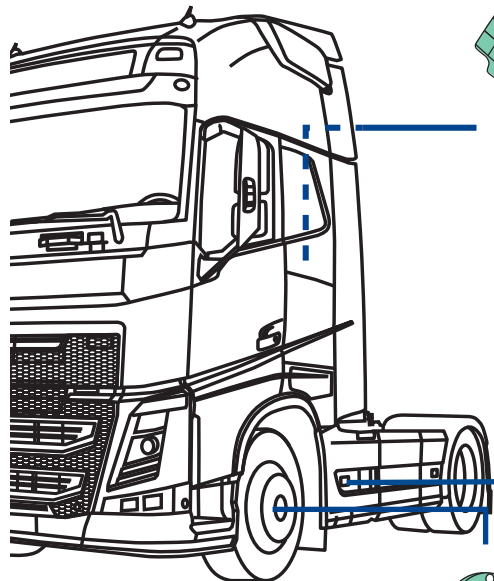

PDS/360

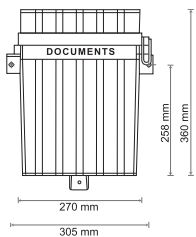

PDS/360

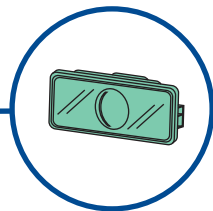

2FH/610
d|s-rh|lh-rechts|links



PRM/700
d|s-rh|lh-rechts|links
PRM/710
d|s-rh|lh-rechts|links

2FH/610 d|s-rh|lh-rechts|links

2002→

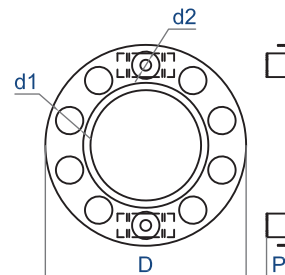
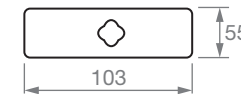

PRM/700 d|s-rh|lh-rechts+links

D ø 425 mm	P 40 mm
d1 nr. 10	d1 ø 58 mm
d2 nr. 2	d2 ø 24 mm
Ventilata	no-nein
Ventilated-Belüftet	
Colore	silver-silver-Silber
Colours-Farbe	
Materiale-Material	acciaio inox-stainless steel Edelstahl
Kg	1,700

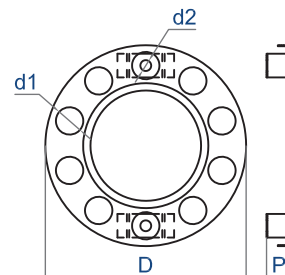

PRM/710 d|s-rh|lh-rechts+links

D ø 425 mm	P 40 mm
d1 nr. 10	d1 ø 58 mm
d2 nr. 2	d2 ø 24 mm
Ventilata	no-nein
Ventilated-Belüftet	
Colore	cromato-chrome-verchromt
Colours-Farbe	
Materiale-Material	acciaio inox-stainless steel Edelstahl
Kg	1,700



2FH/610
O.E.M. 20789440



PDS/360
O.E.M. -



PRM/700
O.E.M. 22709903



PRM/710
O.E.M. -

0FH/675

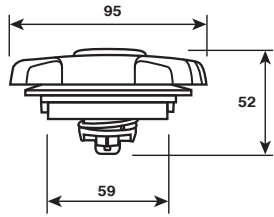

0FH/675

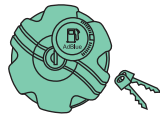

XF0/670

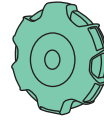

943/670

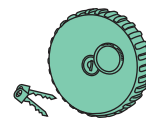

XF0/670

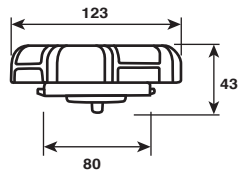

943/670

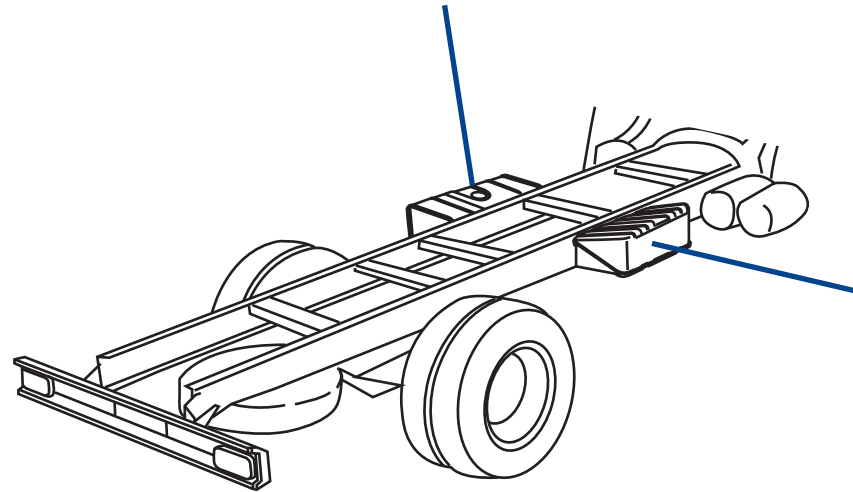
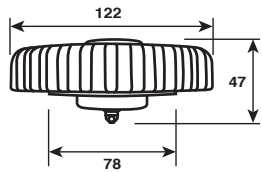

PRM/620

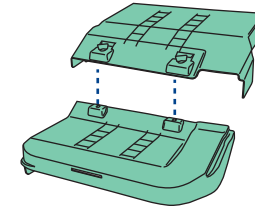

PRM/619



0FH/675
O.E.M. 21281403



XF0/670
O.E.M. -



943/670
O.E.M. 20392752

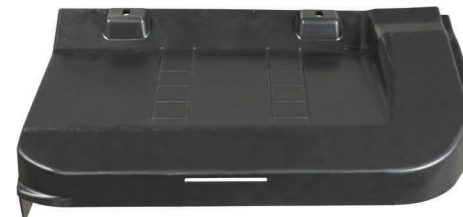

PRM/619
O.E.M. 23417998



PRM/620
O.E.M. 23417997

applicabile a | suitable to | verwendbar für:

FH Euro 6

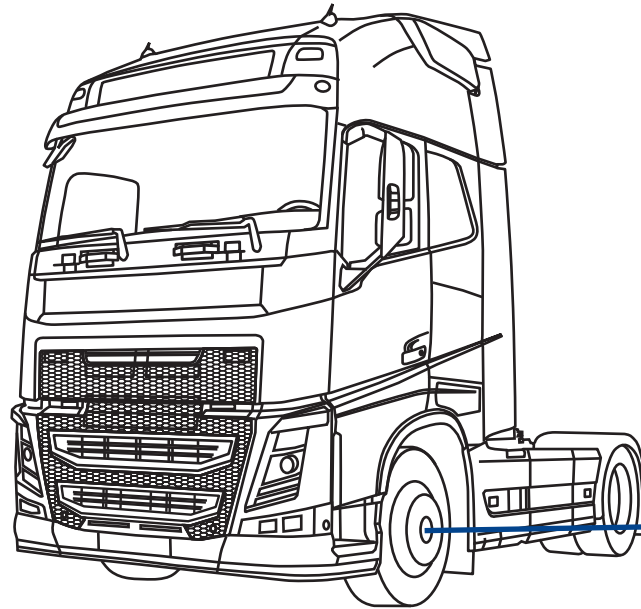

930/033

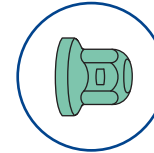

930/001
d-rh-rechts
930/002
s-lh-links

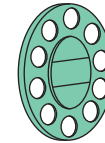

930/200
d|s-rh|lh
rechts|links



930/100
d-rh-rechts
930/101
s-lh-links

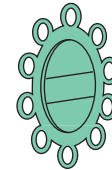

930/033
O.E.M. -



930/001
O.E.M. -
930/002
O.E.M. -



930/100
O.E.M. -
930/101
O.E.M. -



930/200
O.E.M. -

930/033-Tappo copri Bullone-Bolt cover-Radmutterkappen

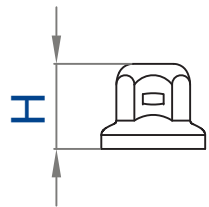

H	45 mm
Per bulloni \varnothing - bolt \varnothing	33 mm
Schlüsselweite \varnothing	
Colore	cromato-chrome-verchromt
Colours-Farbe	
Materiale-Material	acciaio inox-stainless steel
	Edelstahl
Kg	0,025

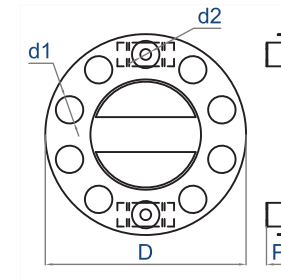

930/001 d-rh-rechts | 930/002 s-lh-links

D \varnothing 425 mm	P 50 mm
d1 nr. 10	d1 \varnothing 58 mm
d2 nr. 2	d2 \varnothing 23 mm
Ventilata	si-yes-Ja
Ventilated-Belüftet	
Colore	cromato e nero-chrome and black
Colours-Farbe	verchromt und schwarz
Materiale-Material	acciaio inox e plastica
	stainless steel and plastic
	Edelstahl und Kunststoff
Kg	1,230

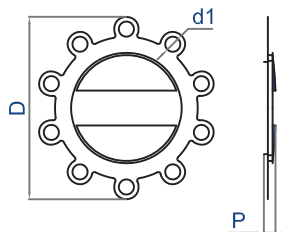

930/100 d-rh-rechts | 930/101 s-lh-links

D \varnothing 387 mm	P 30 mm
d1 nr. 10	d1 \varnothing 32 mm
Ventilata	si-yes-Ja
Ventilated-Belüftet	
Colore	cromato e nero-chrome and black
Colours-Farbe	verchromt und schwarz
Materiale-Material	acciaio inox e plastica
	stainless steel and plastic
	Edelstahl und Kunststoff
Kg	0,655

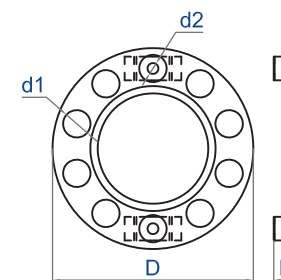

930/200 d|s-rh|lh-rechts+links

D \varnothing 425 mm	P 40 mm
d1 nr. 10	d1 \varnothing 58 mm
d2 nr. 2	d2 \varnothing 23 mm
Ventilata	no-nein
Ventilated-Belüftet	
Colore	cromato-chrome-verchromt
Colours-Farbe	
Materiale-Material	acciaio inox-stainless steel
	Edelstahl
Kg	1,155

gallery





applicabile a | suitable to | verwendbar für

191

3FH

FH13 (2008→2012)

TERZA SERIE | THIRD SERIES | DRITTE SERIE

gallery



(*) Cava-Cantiere
Yard & Quarry
Baustellenfahrzeug

applicabile a | suitable to | verwendbar für:

FH13 TERZA SERIE | THIRD SERIES | DRITTE SERIE

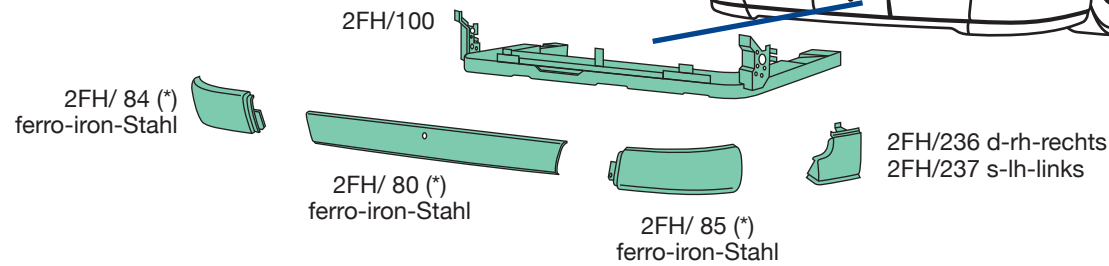

2FH/ 80
O.E.M. 21828914



2FH/ 84
O.E.M. 21829052
2FH/ 85
O.E.M. 21829051



2FH/100
O.E.M. 21484901



2FH/236
O.E.M. 20453677
2FH/237
O.E.M. 20453676

applicabile a | suitable to | verwendbar für:

FH13 TERZA SERIE | THIRD SERIES | DRITTE SERIE

(*) grezzo-unprocessed-roh

(°) verniciato grigio scuro
dark grey painted
dunkel grau strukturlackiert



2FH/ 92 (*)
plastica-plastic-Kunststoff
2FH/ 96 (°)
plastica-plastic-Kunststoff

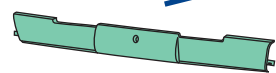

2FH/ 90 (*)
plastica-plastic-Kunststoff
2FH/ 89 (°)
plastica-plastic-Kunststoff

2FH/ 93 (*)
plastica-plastic-Kunststoff
2FH/ 97 (°)
plastica-plastic-Kunststoff



2FH/ 89
O.E.M. 20529740



2FH/ 90
O.E.M. 21359080



2FH/ 92
O.E.M. 21359090
2FH/ 93
O.E.M. 21359082



2FH/ 96
O.E.M. 20529742
2FH/ 97
O.E.M. 20529741

FH13 TERZA SERIE | THIRD SERIES | DRITTE SERIE

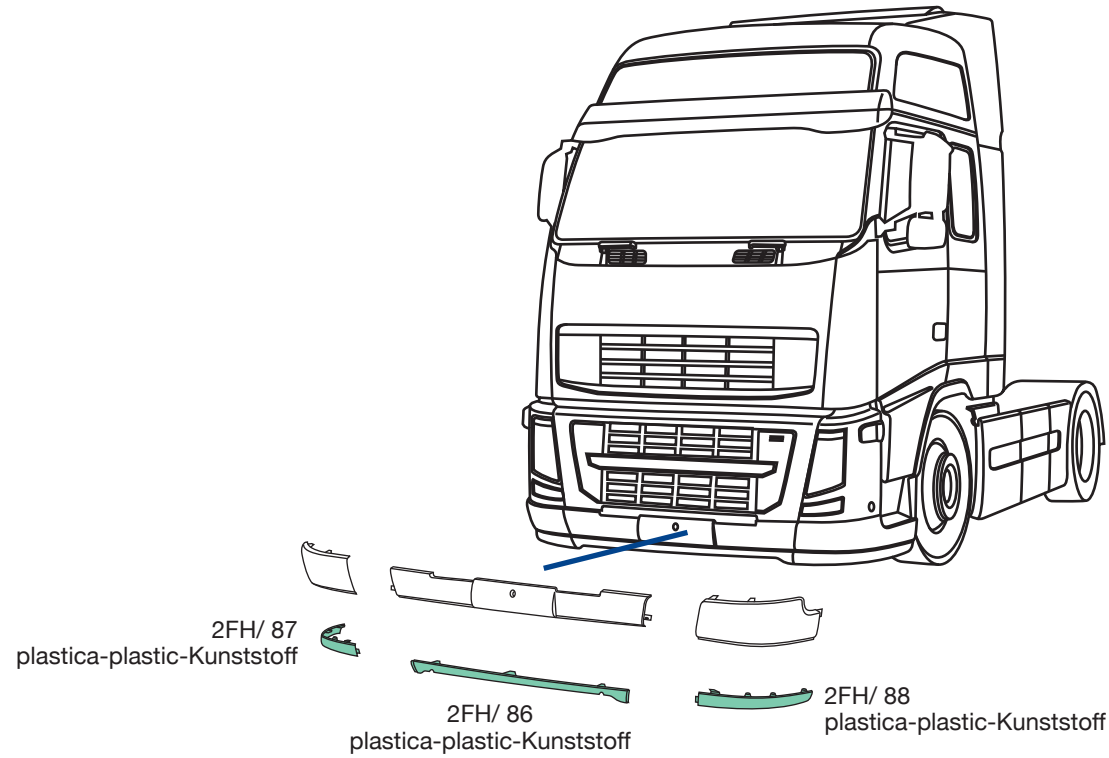

2FH/ 86
O.E.M. 21430599

2FH/ 87
O.E.M. 21430672
2FH/ 88
O.E.M. 21430600

applicabile a | suitable to | verwendbar für:

FH13 TERZA SERIE | THIRD SERIES | DRITTE SERIE

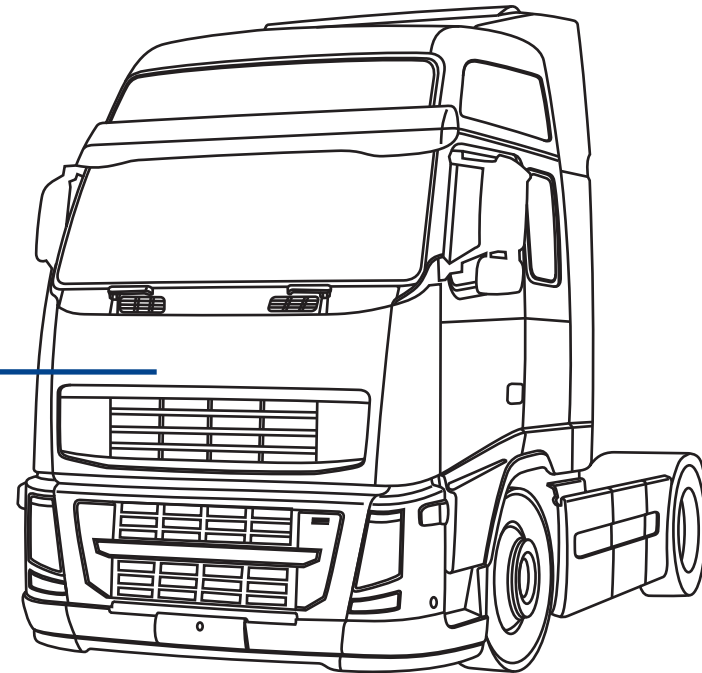
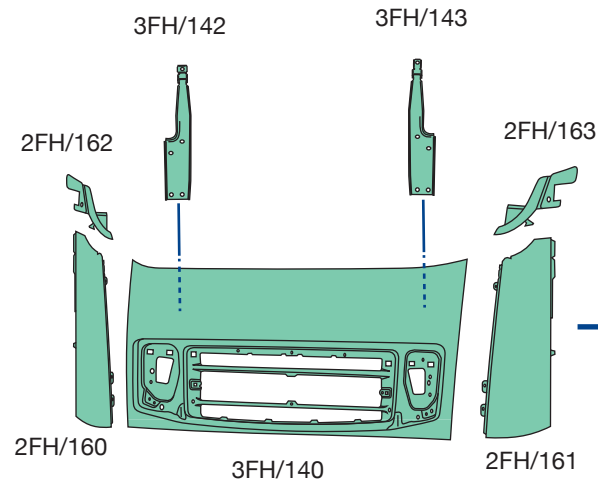

3FH/140
O.E.M. 21190825



3FH/142
O.E.M. 82215401
3FH/143
O.E.M. 82215391



2FH/160
O.E.M. 20379176
2FH/161
O.E.M. 20379175



2FH/162
O.E.M. 20529672
2FH/163
O.E.M. 20529668

FH13 terza serie | third series | dritte serie

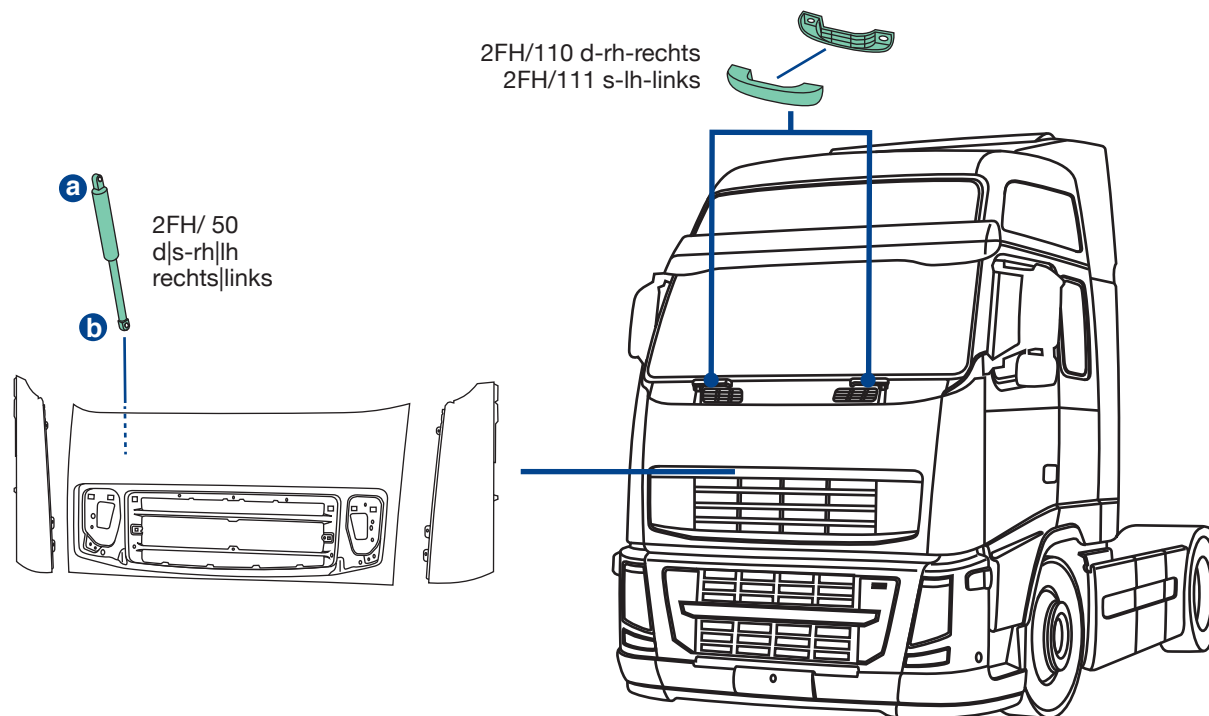

2FH/110
O.E.M. 3175367+3175366
2FH/111
O.E.M. 20383543+3175366

applicabile a | suitable to | verwendbar für:

FH13 TERZA SERIE | THIRD SERIES | DRITTE SERIE

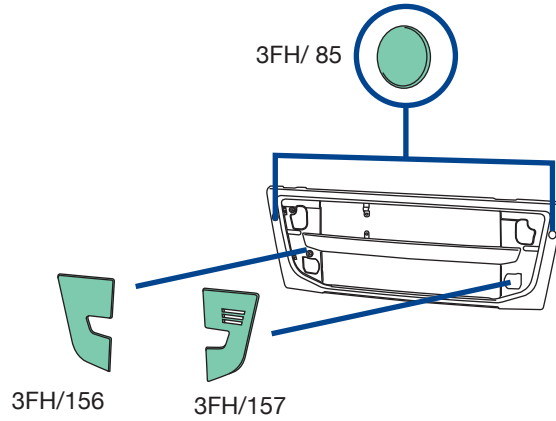

3FH/150
con fori lavafari
with headlamp wiper holes
mit Löcher für Scheinwerferwischer

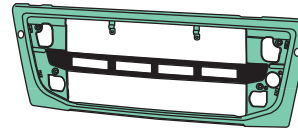
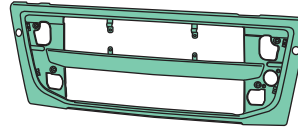

3FH/151
con fori lavafari
with headlamp wiper holes
mit schwarz lackierten Mittelteil



3FH/ 85
O.E.M. 21425186



3FH/150
O.E.M. 21445302



3FH/151
O.E.M. 21445754



3FH/156
O.E.M. 82063911



3FH/157
O.E.M. 82062209

FH13 TERZA SERIE | THIRD SERIES | DRITTE SERIE

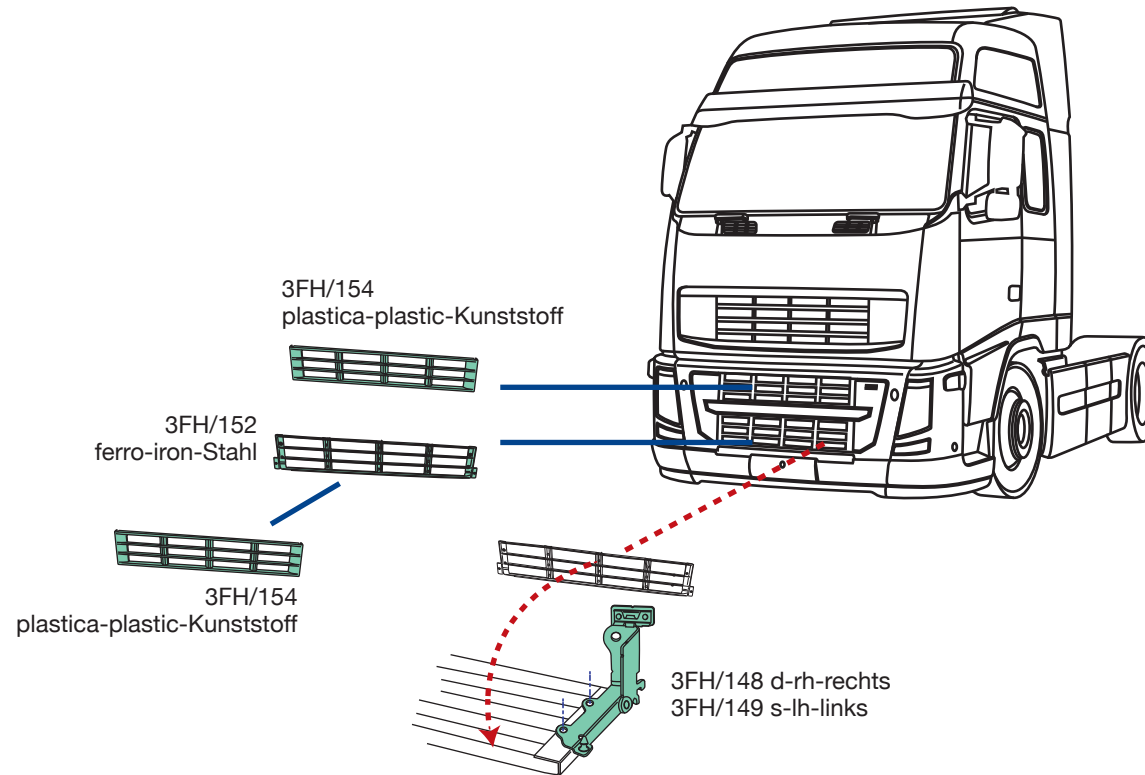

3FH/148
O.E.M. 82060445
3FH/149
O.E.M. 82060441



3FH/152
O.E.M. 82072463



3FH/154
O.E.M. 82063513

applicabile a | suitable to | verwendbar für:

FH13 TERZA SERIE | THIRD SERIES | DRITTE SERIE

3FH/602 d-rh-rechts | 3FH/603 s-lh-links 2008→2012

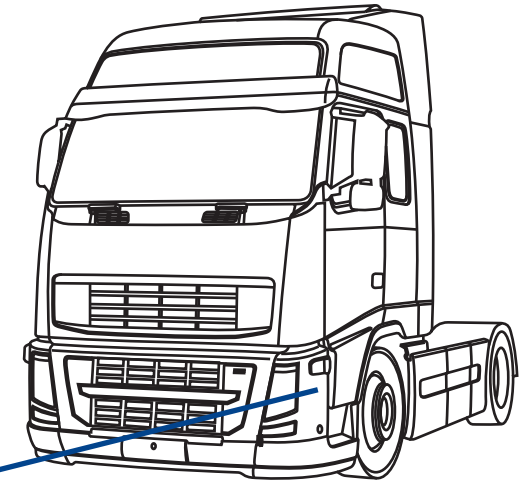

3FH/ 94
d-rh-rechts
3FH/ 95
s-lh-links



3FH/ 98 d-rh-rechts
3FH/ 99 s-lh-links
con staffa
with bracket
mit Halter



3FH/602
d-rh-rechts
3FH/603
s-lh-links

3FH/134 d-rh-rechts
3FH/135 s-lh-links



3FH/ 94
O.E.M. 21451002
3FH/ 95
O.E.M. 21451000



3FH/ 98
O.E.M. 82209849
3FH/ 99
O.E.M. 82367098

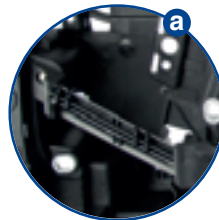

3FH/134
O.E.M. 21478755
3FH/135
O.E.M. 21478759



3FH/602
O.E.M. 82304585
3FH/603
O.E.M. 82304599

3FH/700 d-rh-rechts | 3FH/701 s-lh-links 2008→2012



3FH/702 d-rh-rechts | 3FH/703 s-lh-links 2008→2012



CON LUCE SUPPLEMENTARE
WITH ADDITIONAL LIGHT
MIT ZUSÄTZLICHEM LICHT



3FH/704 d-rh-rechts | 3FH/705 s-lh-links 2008→2012



CON LUCE DI PROFONDITÀ
WITH HIGH BEAM
MIT FERNLICHT



FH13 TERZA SERIE | THIRD SERIES | DRITTE SERIE

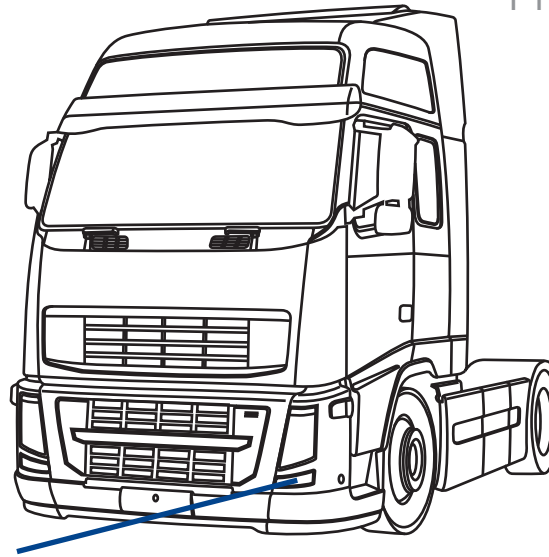

- 3FH/700 d-rh-rechts
- 3FH/701 s-lh-links
- 3FH/702 d-rh-rechts
- 3FH/703 s-lh-links
- 3FH/704 d-rh-rechts
- 3FH/705 s-lh-links



3FH/700
O.E.M. 21297909
3FH/701
O.E.M. 21297911



3FH/702
O.E.M. 21297904
3FH/703
O.E.M. 21297905



3FH/704
O.E.M. 21297917
3FH/705
O.E.M. 21297918

applicabile a | suitable to | verwendbar für:

FH13 TERZA SERIE | THIRD SERIES | DRITTE SERIE

3FH/610 d-rh-rechts | 3FH/611 s-lh-links

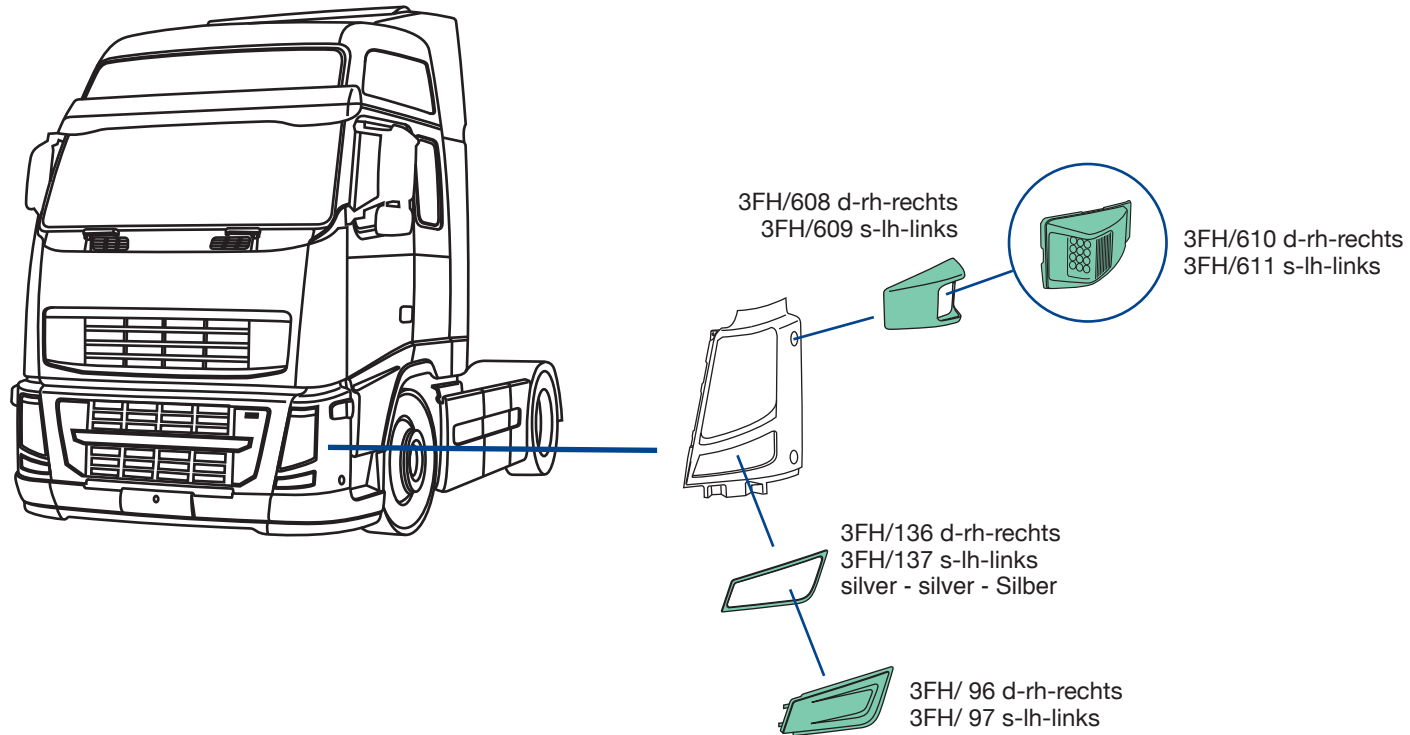

3FH/ 96
O.E.M. 82066335
3FH/ 97
O.E.M. 82066238



3FH/136
O.E.M. 21078545
3FH/137
O.E.M. 21078543



3FH/608
O.E.M. 21478751
3FH/609
O.E.M. 21448885



3FH/610
O.E.M. 82114500
3FH/611
O.E.M. 84139937

FH13 TERZA SERIE | THIRD SERIES | DRITTE SERIE

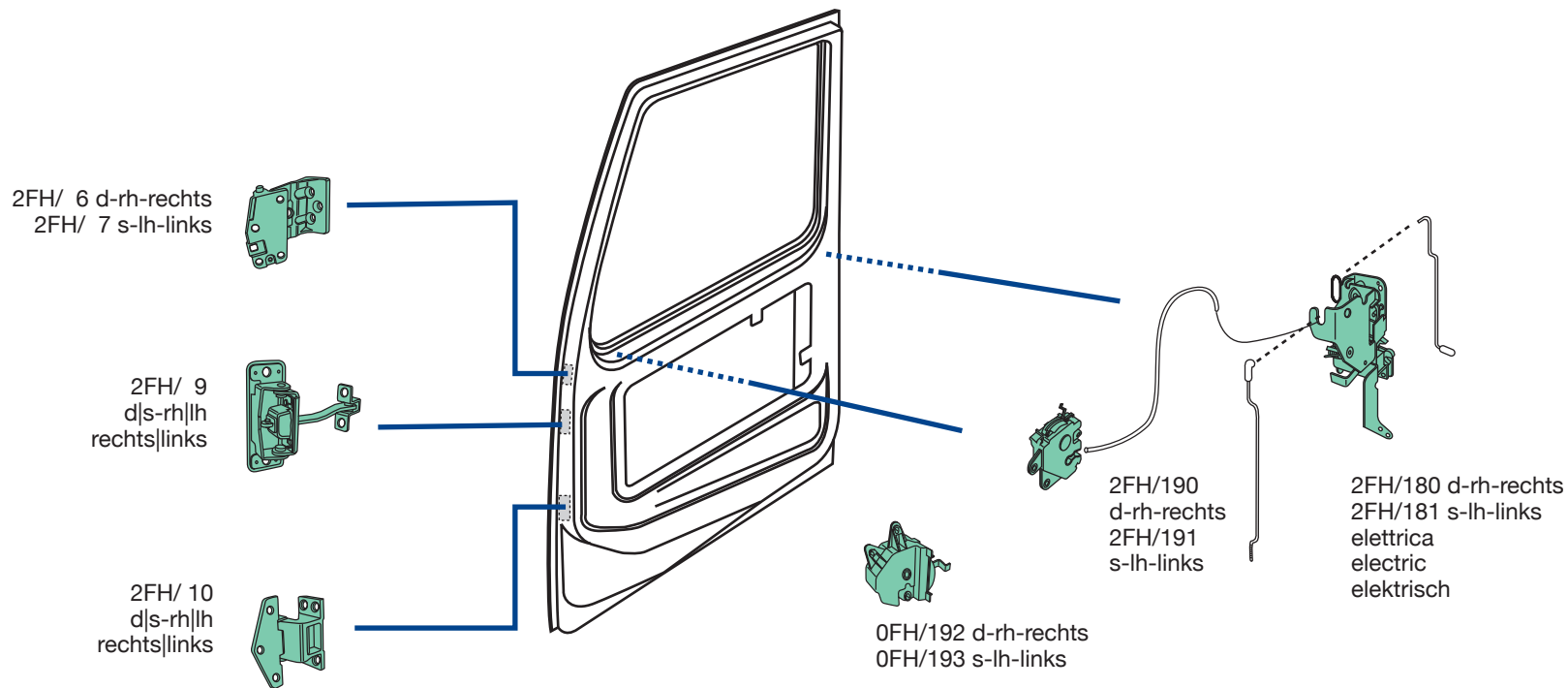

0FH/192
O.E.M. 1063328
0FH/193
O.E.M. 1063327



2FH/ 6
O.E.M. 20398136
2FH/ 7
O.E.M. 20398135



2FH/ 9
O.E.M. 1062636



2FH/ 10
O.E.M. 20372039



2FH/180
O.E.M. 21505894
2FH/181
O.E.M. 21505893



2FH/190
O.E.M. 20570722
2FH/191
O.E.M. 20570721

applicabile a | suitable to | verwendbar für:

FH13 TERZA SERIE | THIRD SERIES | DRITTE SERIE

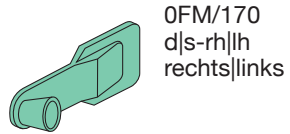
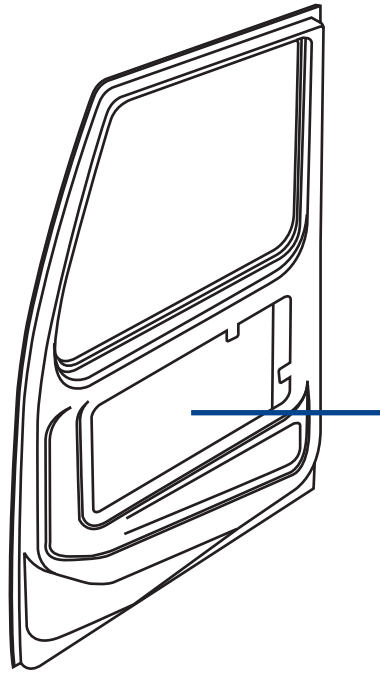

OFM/170
d|s-rh|lh
rechts|links

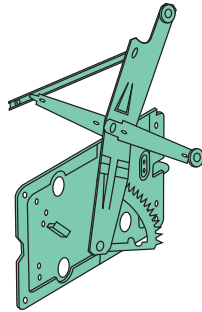

OFM/174 d-rh-rechts
OFM/175 s-lh-links
elettrico, senza motorino
electric, without motor
elektrisch, ohne Motor

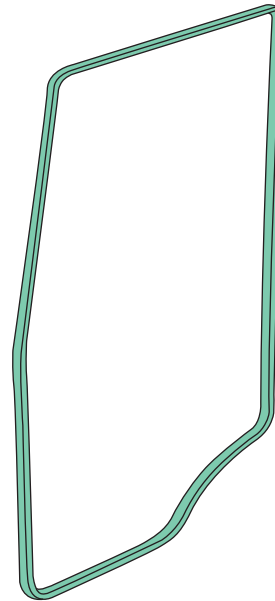

OFH/190

OFH/190

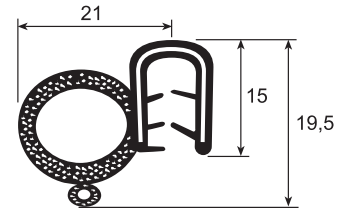

OFM/170
O.E.M. 8140016



OFM/174
O.E.M. -
OFM/175
O.E.M. -



OFH/190
O.E.M. 3175029

FH13 TERZA SERIE | THIRD SERIES | DRITTE SERIE

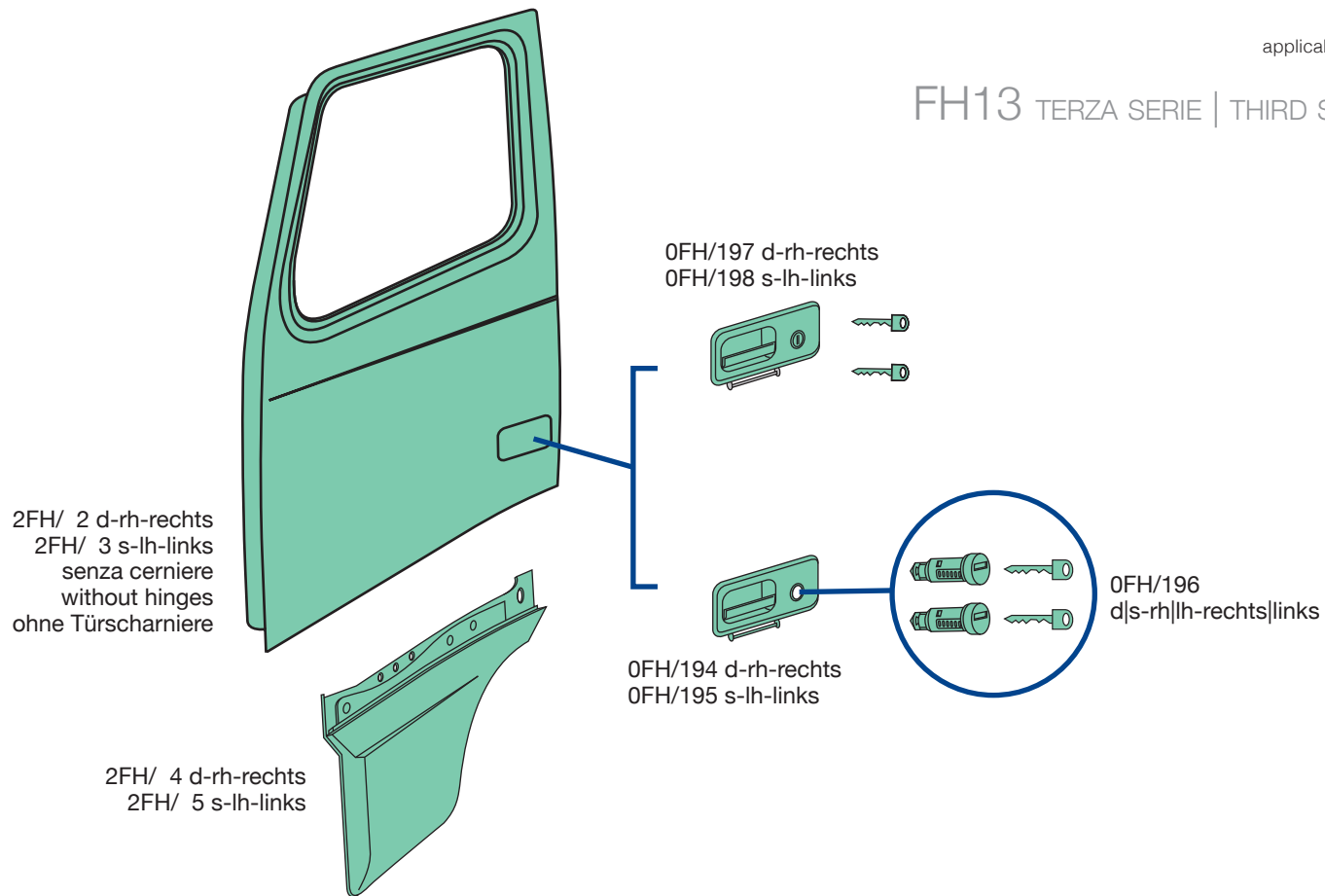

0FH/194
O.E.M. 20398467
0FH/195
O.E.M. 20398466



0FH/196
O.E.M. 3090484



0FH/197
O.E.M. -
0FH/198
O.E.M. -



2FH/ 2
O.E.M. 20360543
2FH/ 3
O.E.M. 20360542



2FH/ 4
O.E.M. 21300059
2FH/ 5
O.E.M. 21299955

applicabile a | suitable to | verwendbar für:



FH13 TERZA SERIE | THIRD SERIES | DRITTE SERIE

3FH/504

22286155



II

E4 024111

200x435 mm



IV

E4 0244639

200x185 mm

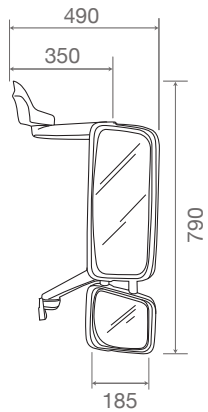

applicabilità:
applicable to:
Verwendbar für

VOLVO 3FH. FH III
VOLVO 3FM. FM III
VOLVO 4FM. FM euro 6



COVIND
II
IV

3FH/506



240x235 mm

a

-

-

b

2FH/503

21320404
(20589788)



E4 024111
200x435 mm

II

c

3FH/509

21320365
(21070768)
(20589798)



E4 0244639
200x185 mm

IV

d

3FH/511

21169974
(20746402)



187x435 mm

II

e

3FH/508

20841436



240x210 mm

IV

applicabile a | suitable to | verwendbar für:



FH13 TERZA SERIE | THIRD SERIES | DRITTE SERIE

3FH/505

22286149



II

E4 024111

200x435 mm



IV

E4 0244639

176x188 mm

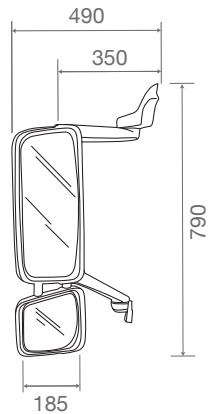

applicabilità:
applicable to:
Verwendbar für

VOLVO 3FH. FH III
VOLVO 3FM. FM III
VOLVO 4FM. FM euro 6



COVIND
II
3FH/507
IV



240x235 mm

a

-

b

2FH/503

21320404
(20589788)



E4 024111
200x435 mm

II

c

3FH/509

21320365
(21070768)
(20589798)



E4 0244639
185x200 mm

IV

d

3FH/511

21169974
(20746402)



187x435 mm

II

e

3FH/508

20841436



240x210 mm

IV

applicabile a | suitable to | verwendbar für:

FH13 TERZA SERIE | THIRD SERIES | DRITTE SERIE

3FH/514

20716956

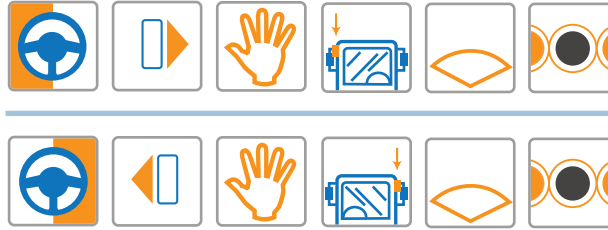

VI

E9 026323

255x142 mm

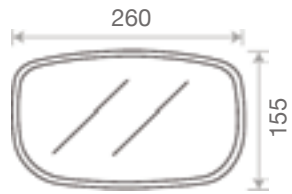

applicabilità:
applicable to:
Verwendbar für

VOLVO 3FH. FH III
VOLVO 2FM. FM II



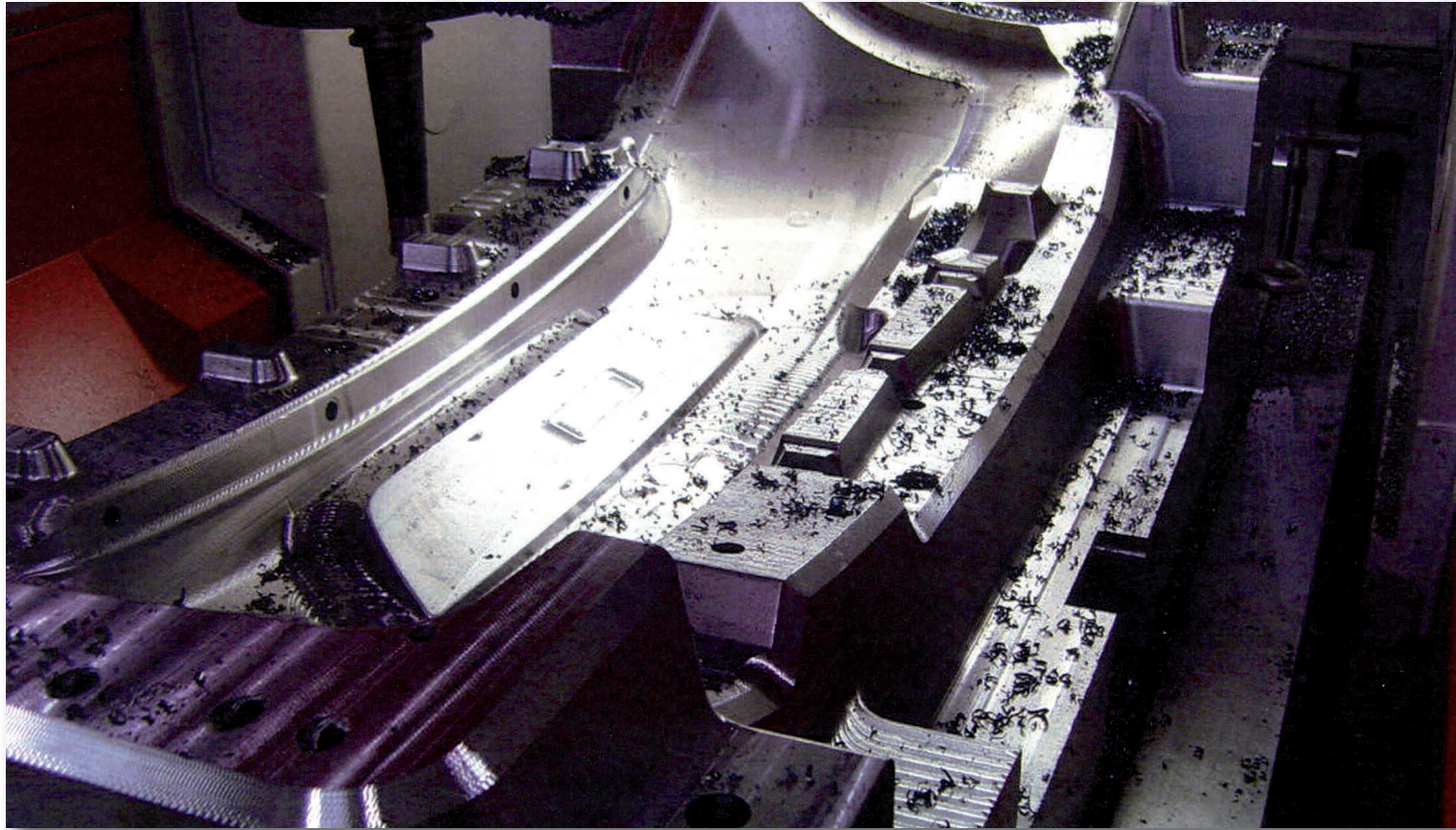

applicabile a | suitable to | verwendbar für:

FH13 TERZA SERIE | THIRD SERIES | DRITTE SERIE

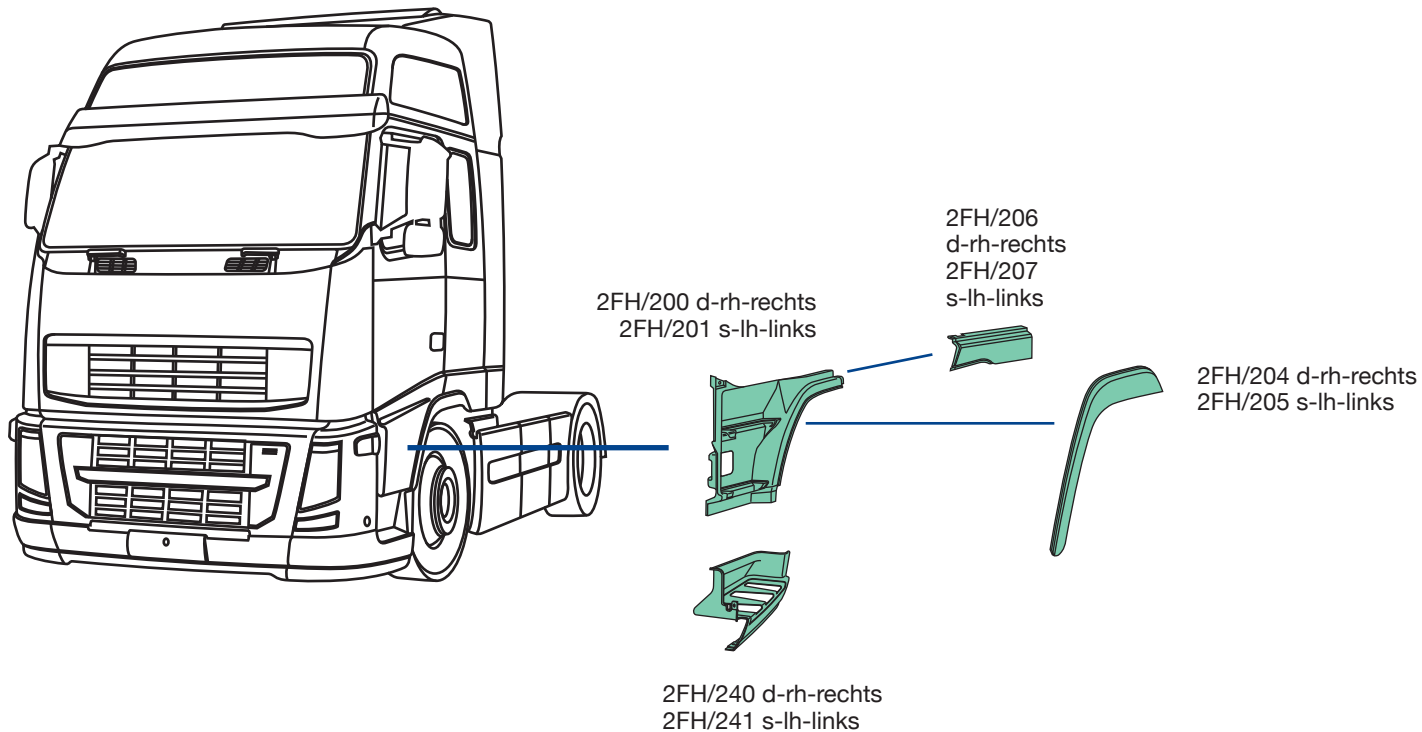

2FH/200
O.E.M. 3175928
2FH/201
O.E.M. 3175927



2FH/204
O.E.M. 20529684
2FH/205
O.E.M. 20529682



2FH/206
O.E.M. 21302470
2FH/207
O.E.M. 21302461



2FH/240
O.E.M. 20529640
2FH/241
O.E.M. 20529638

FH13 TERZA SERIE | THIRD SERIES | DRITTE SERIE

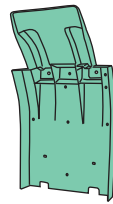

3FH/323
d|s-rh||lh
rechts|links

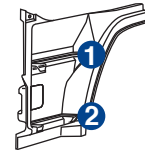

1

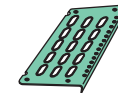

0FH/210
d|s-rh||lh-rechts|links



2



2FH/208 d-rh-rechts
2FH/209 s-lh-links



0FH/210
O.E.M. 20379439



2FH/208
O.E.M. 20360789
2FH/209
O.E.M. 20360788



3FH/323
O.E.M. 82637695

applicabile a | suitable to | verwendbar für:

FH13 TERZA SERIE | THIRD SERIES | DRITTE SERIE

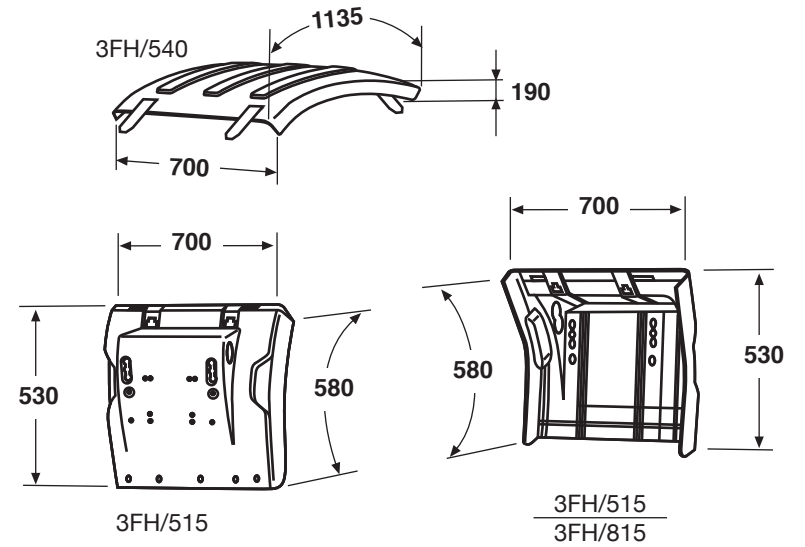
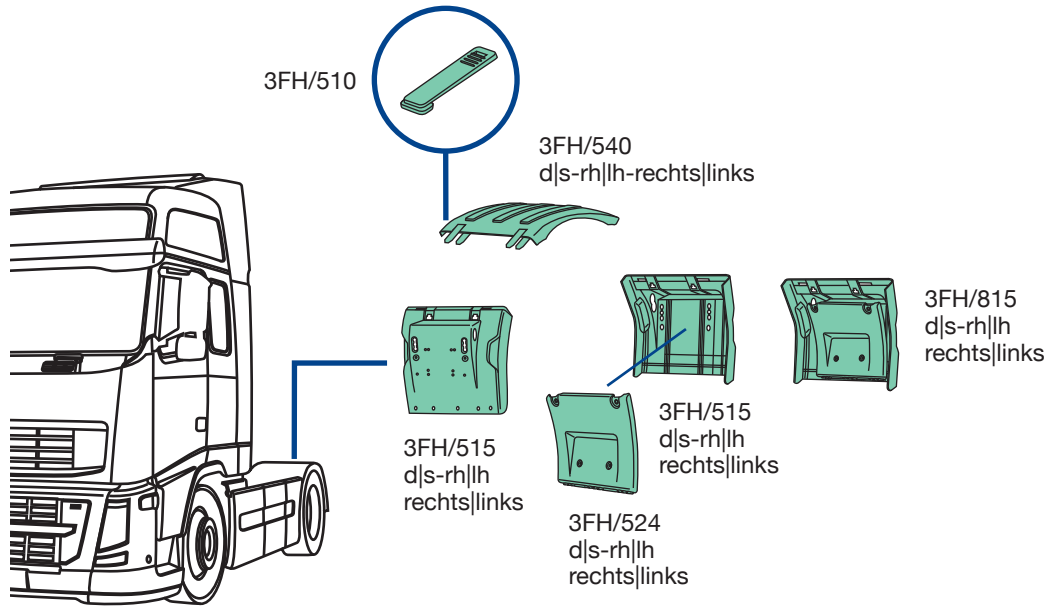

3FH/510
O.E.M. 21094457



3FH/524
O.E.M. 21094447



3FH/540
O.E.M. 21094390
d|s-rh|lh-rechts|links
nero, semipiatta,
con cinghietti
black, semi-flat,
with stretchers
schwarz, halbflach,
mit Spanngummi

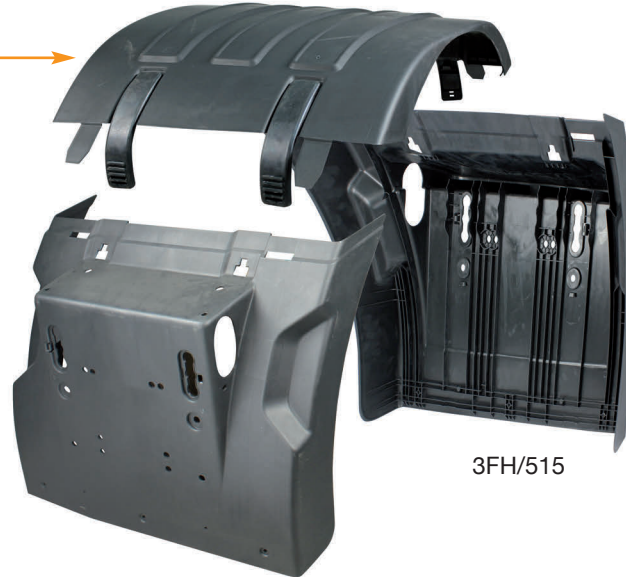
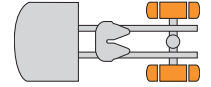

3FH/515
O.E.M. 21094391
d|s-rh|lh-rechts|links
nero-black-schwarz

3FH/515

3FH/815
O.E.M. -
d|s-rh|lh-rechts|links
nero-black-schwarz



3FH/815 O.E.M. -

**KIT
Satz**

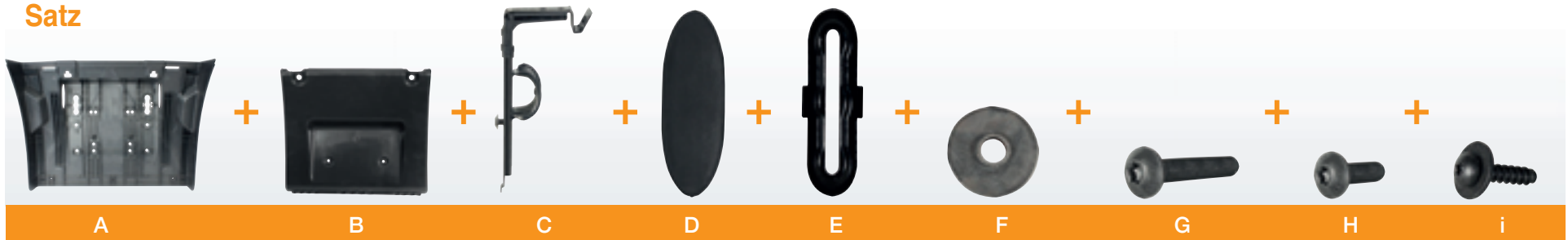

3FH/515
O.E.M. 21094391
1 pz.-pcs.-Stk.

3FH/524
O.E.M. 21094447
1 pz.-pcs.-Stk.

3FH/526
O.E.M. 21094456 +
21094454
2 pz.-pcs.-Stk.

-
O.E.M. 21094449
1 pz.-pcs.-Stk.

-
O.E.M. 21094453
2 pz.-pcs.-Stk.

-
O.E.M. 21094451
6 pz.-pcs.-Stk.

-
O.E.M. 992426
2 pz.-pcs.-Stk.

-
O.E.M. 992423
6 pz.-pcs.-Stk.

-
O.E.M. 60112154
2 pz.-pcs.-Stk.

FH13 TERZA SERIE | THIRD SERIES | DRITTE SERIE

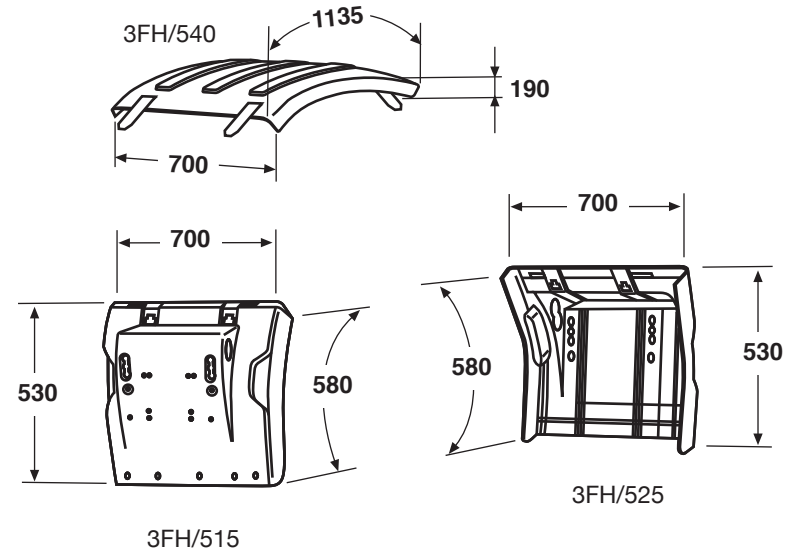
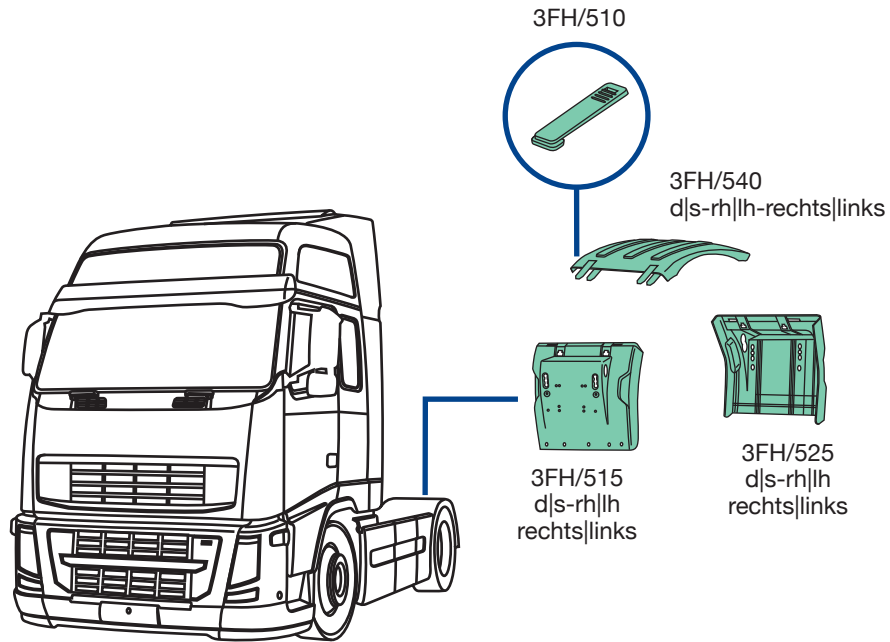

3FH/510
O.E.M. 21094457

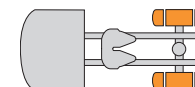

3FH/540
 O.E.M. 21094390
 d|s-rh|lh-rechts|links
 nero, semipiatta, con cinghietti
 black, semi-flat, with stretchers
 schwarz, halbfach, mit Spanngummi



3FH/515
 O.E.M. 21094391
 d|s-rh|lh-rechts|links
 nero-black-schwarz

3FH/525
 O.E.M. 21094394
 d|s-rh|lh-rechts|links
 nero, senza anti-spray
 black, without anti-spray
 schwarz, ohne Spritzschutz



applicabile a | suitable to | verwendbar für:

FH13 TERZA SERIE | THIRD SERIES | DRITTE SERIE

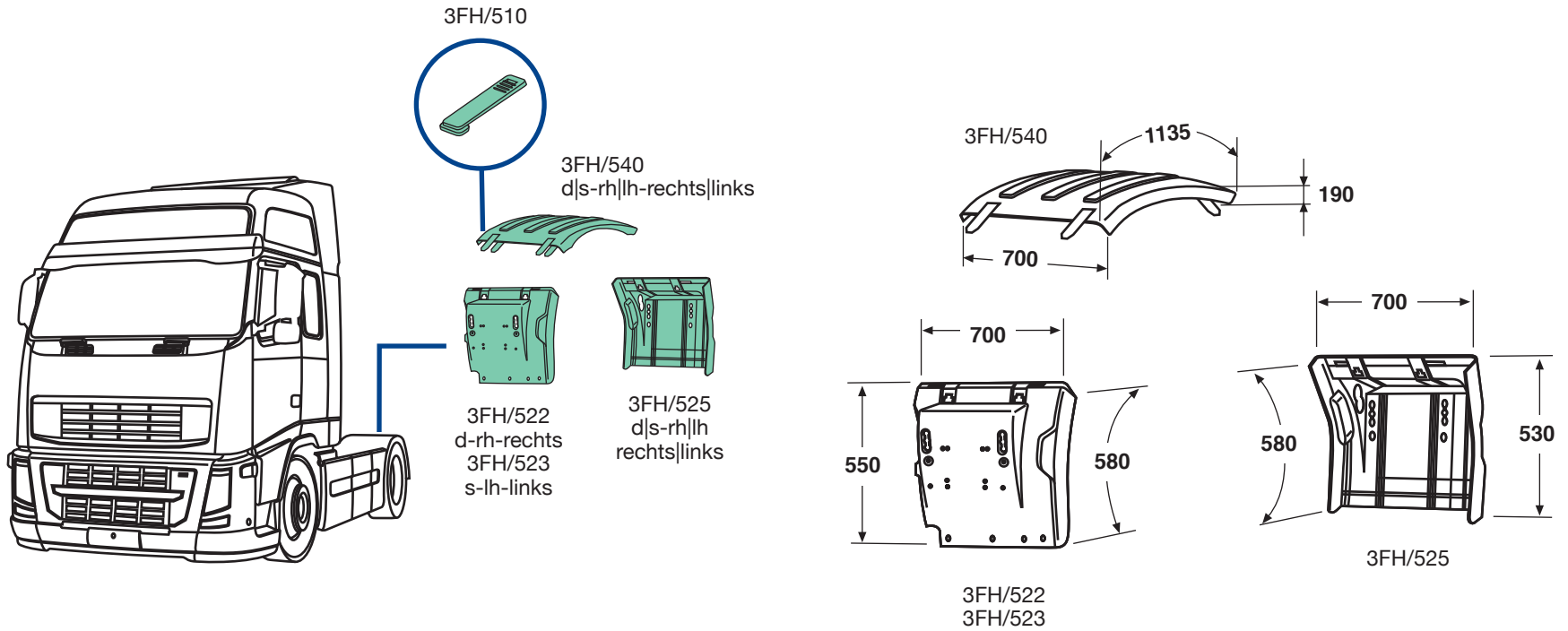

3FH/510
O.E.M. 21094457

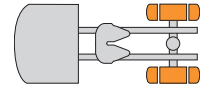

3FH/540
 O.E.M. 21094390
 d|s-rh|lh-rechts|links
 nero, semipiatta, con cinghietti
 black, semi-flat, with stretchers
 schwarz, halbflach, mit Spanngummi

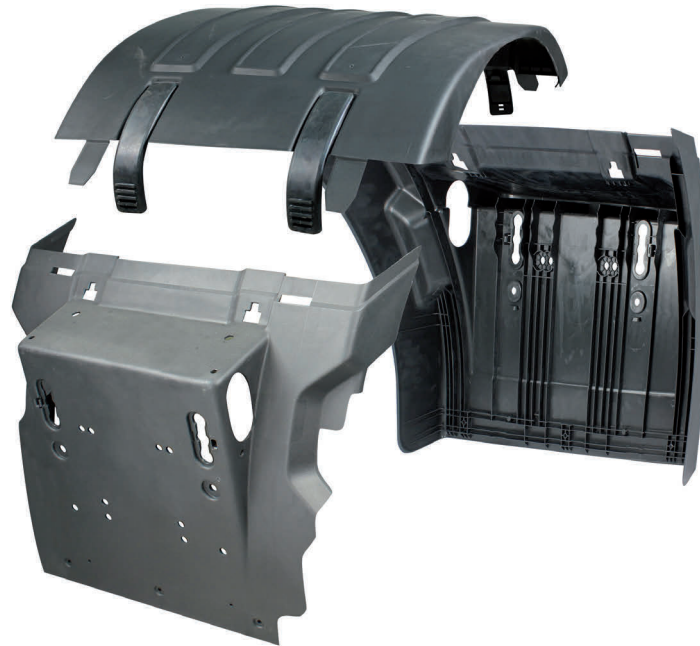

3FH/540



3FH/525

3FH/525
 O.E.M. 21094394
 d|s-rh|lh-rechts|links
 nero, senza anti-spray
 black, without anti-spray
 schwarz, ohne Spritzschutz



3FH/523
 O.E.M. 21094393
 s-lh-links
 nero-black-schwarz

3FH/522
 O.E.M. 21094392
 d-rh-rechts
 nero-black-schwarz

applicabile a | suitable to | verwendbar für:

FH13 TERZA SERIE | THIRD SERIES | DRITTE SERIE

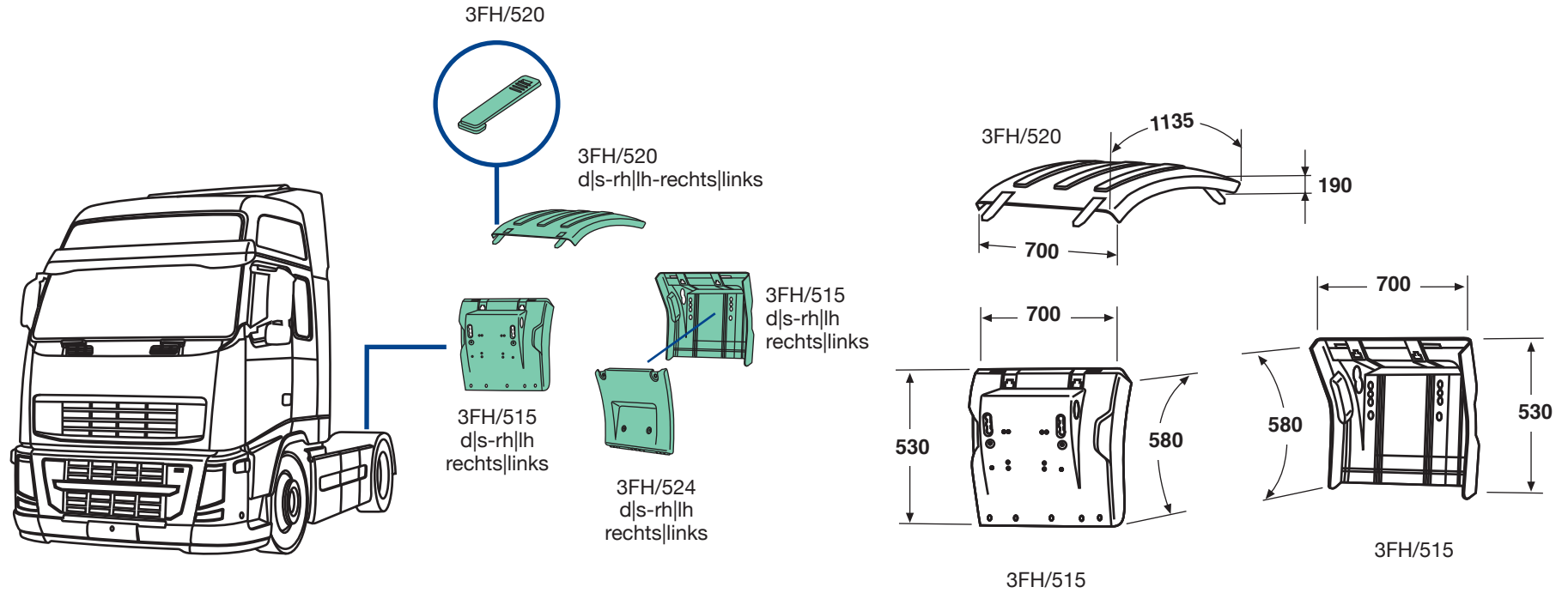

3FH/510
O.E.M. 21094457



3FH/524
O.E.M. 21094447

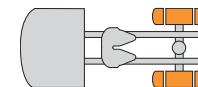

3FH/520
 O.E.M. 21094388
 d|s-rh|lh-rechts|links
 nero, semipiatta, con cinghietti
 black, semi-flat, with stretchers
 schwarz, halbflach, mit Spanngummi



3FH/515
 O.E.M. 21094391
 d|s-rh|lh-rechts|links
 nero-black-schwarz

3FH/515

applicabile a | suitable to | verwendbar für:

FH13 TERZA SERIE | THIRD SERIES | DRITTE SERIE

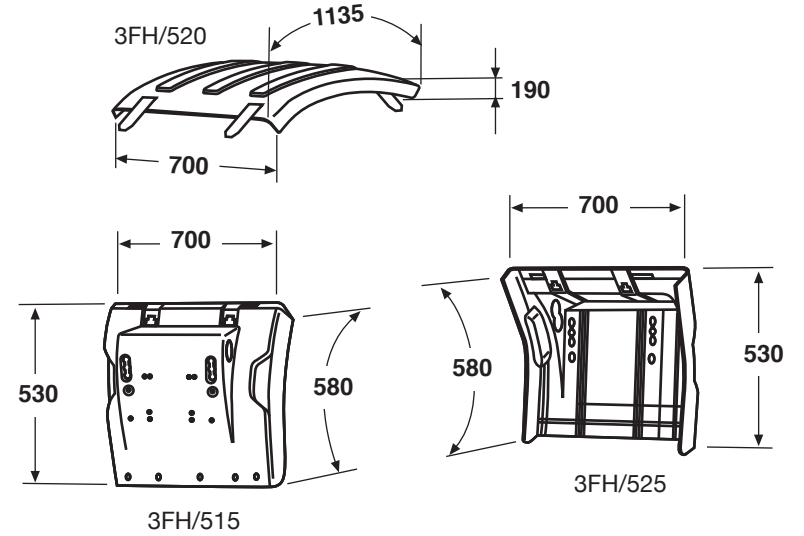
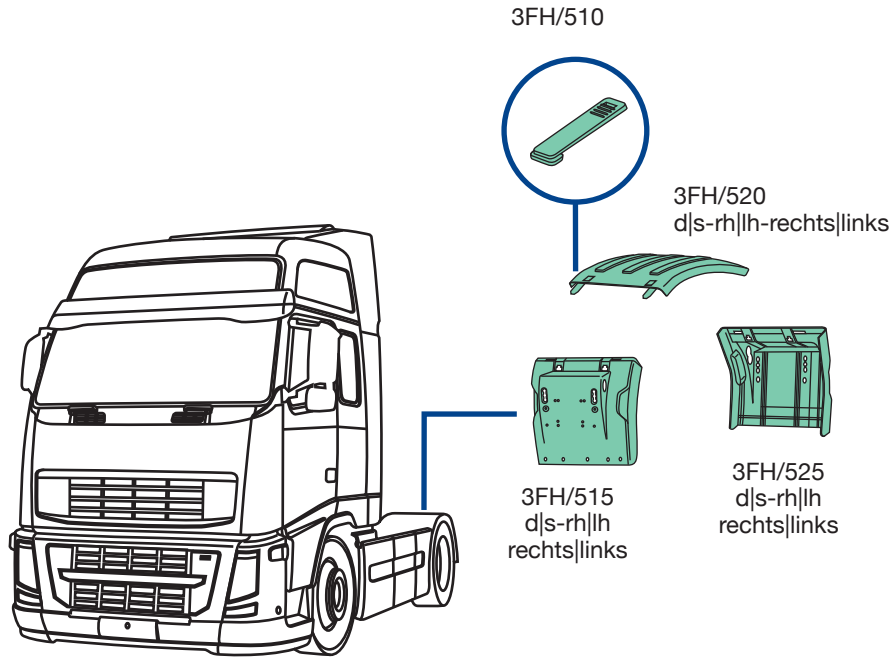

3FH/510
O.E.M. 21094457

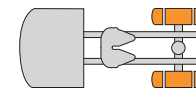

3FH/520
 O.E.M. 21094388
 d|s-rh|lh-rechts|links
 nero, semipiatta, con cinghietti
 black, semi-flat, with stretchers
 schwarz, halbflach, mit Spanngummi



3FH/515
 O.E.M. 21094391
 d|s-rh|lh-rechts|links
 nero-black-schwarz

3FH/525
 O.E.M. 21094394
 d|s-rh|lh-rechts|links
 nero, senza anti-spray
 black, without anti-spray
 schwarz, ohne Spritzschutz



applicabile a | suitable to | verwendbar für:

FH13 TERZA SERIE | THIRD SERIES | DRITTE SERIE

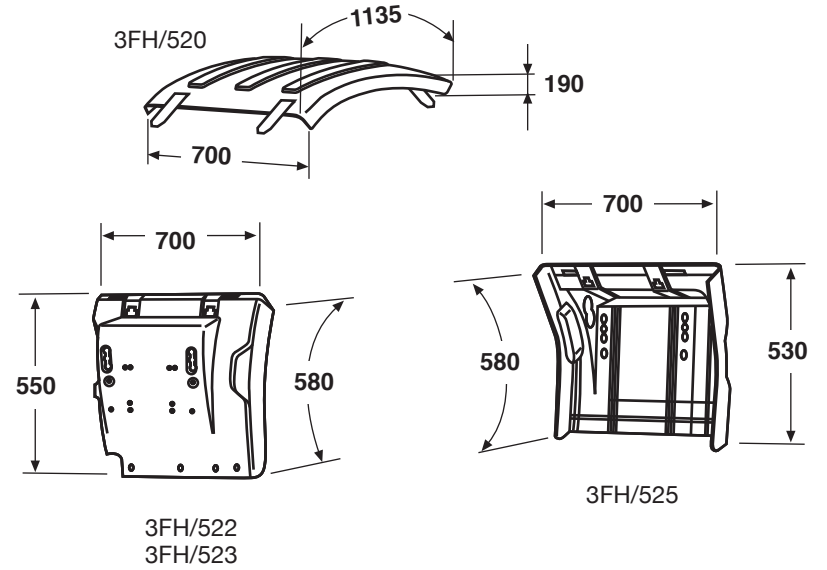
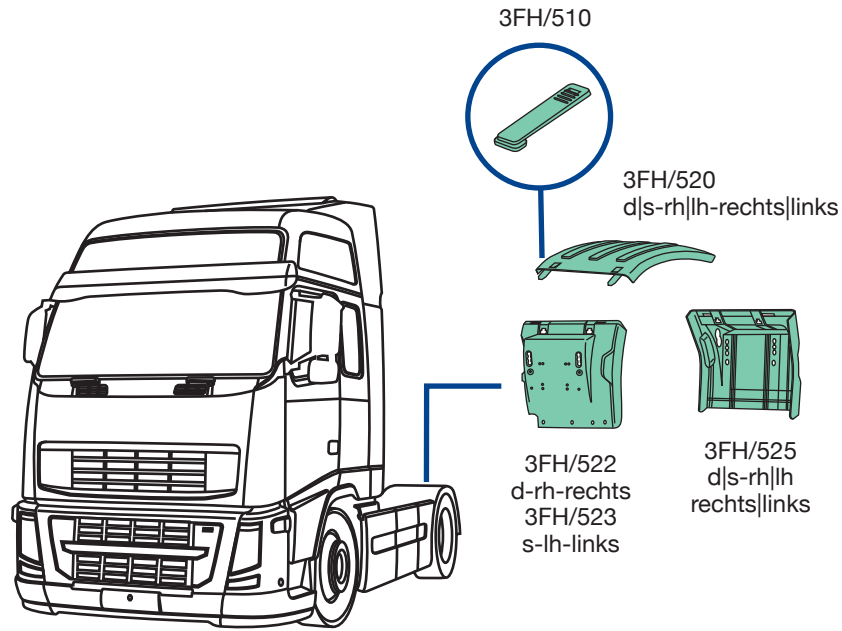

3FH/510
O.E.M. 21094457

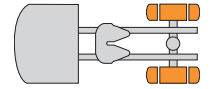

3FH/520
 O.E.M. 21094388
 d|s-rh||h-rechts|links
 nero, semipiatta, con cinghietti
 black, semi-flat, with stretchers
 schwarz, halbflach, mit Spanngummi



3FH/522
 O.E.M. 21094392
 d-rh-rechts
 nero-black-schwarz

3FH/525
 O.E.M. 21094394
 d|s-rh||h-rechts|links
 nero, senza anti-spray
 black, without anti-spray
 schwarz, ohne Spritzschutz



3FH/520



3FH/525

3FH/523
 O.E.M. 21094393
 s-lh-links
 nero-black-schwarz

applicabile a | suitable to | verwendbar für:

FH13 TERZA SERIE | THIRD SERIES | DRITTE SERIE

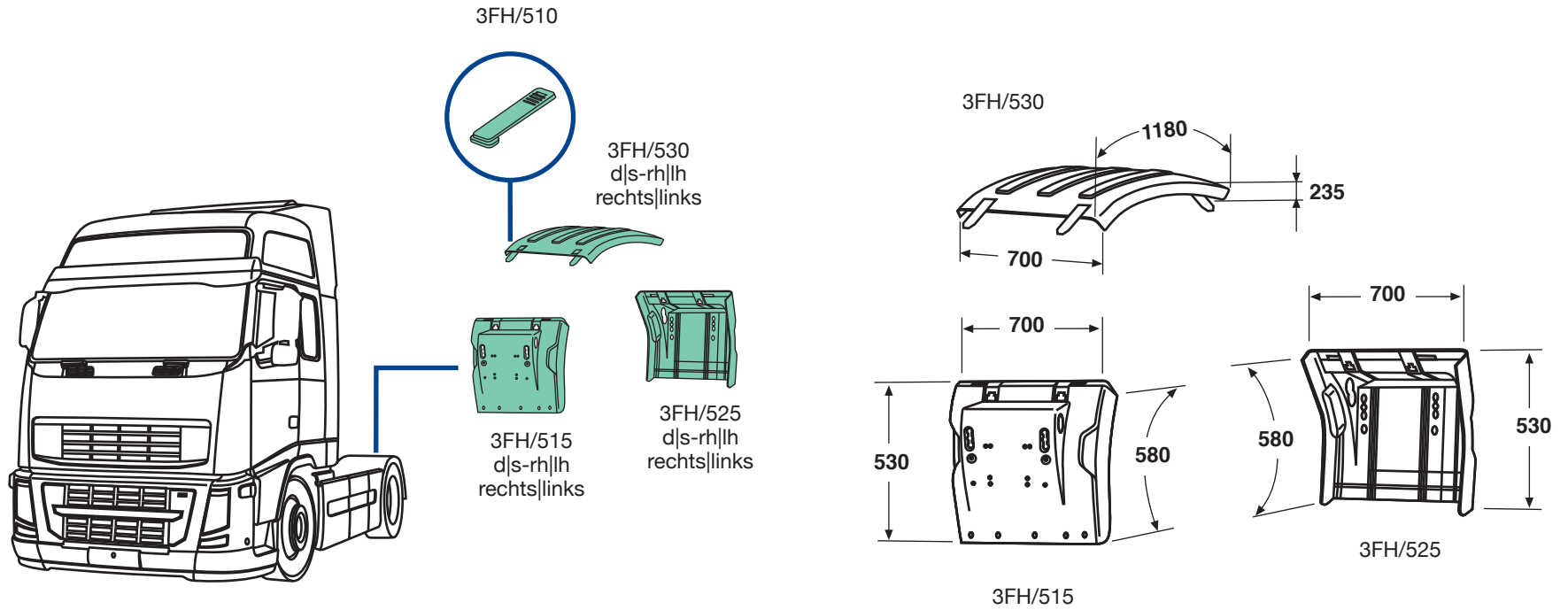

3FH/510
O.E.M. 21094457

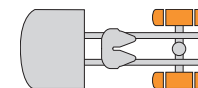

3FH/530
 O.E.M. 21094383
 d|s-rh|lh-rechts|links
 nero, circolare, senza cinghietti
 black, circular, without stretchers
 schwarz, kreisförmig, ohne Spanngummi



3FH/515
 O.E.M. 21094391
 d|s-rh|lh-rechts|links
 nero-black-schwarz

3FH/525
 O.E.M. 21094394
 d|s-rh|lh-rechts|links
 nero, senza anti-spray
 black, without anti-spray
 schwarz, ohne Spritzschutz



applicabile a | suitable to | verwendbar für:

FH13 TERZA SERIE | THIRD SERIES | DRITTE SERIE

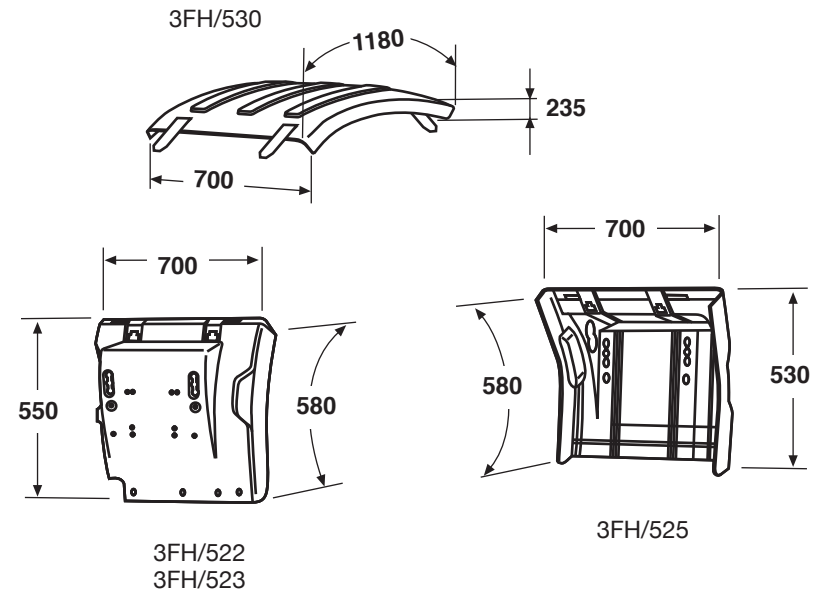
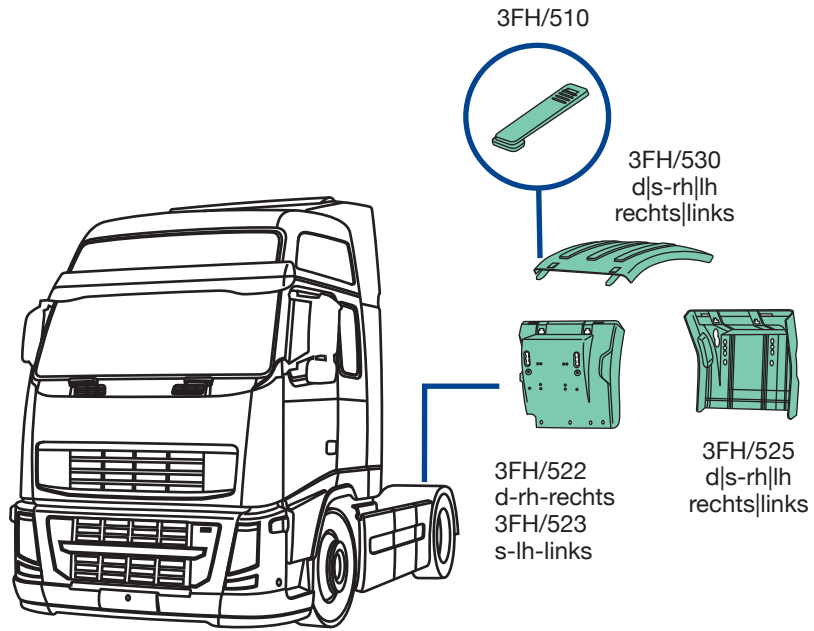

3FH/510
O.E.M. 21094457

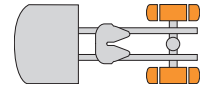

3FH/530
 O.E.M. 21094383
 d|s-rh|lh-rechts|links
 nero, circolare, senza cinghietti
 black, circular, without stretchers
 schwarz, kreisförmig, ohne Spanngummi



3FH/522
 O.E.M. 21094392
 d-rh-rechts
 nero-black-schwarz

3FH/525
 O.E.M. 21094394
 d|s-rh|lh-rechts|links
 nero, senza anti-spray
 black, without anti-spray
 schwarz, ohne Spritzschutz



3FH/530



3FH/525

3FH/523
 O.E.M. 21094393
 s-lh-links
 nero-black-schwarz

applicabile a | suitable to | verwendbar für:

FH13 TERZA SERIE | THIRD SERIES | DRITTE SERIE

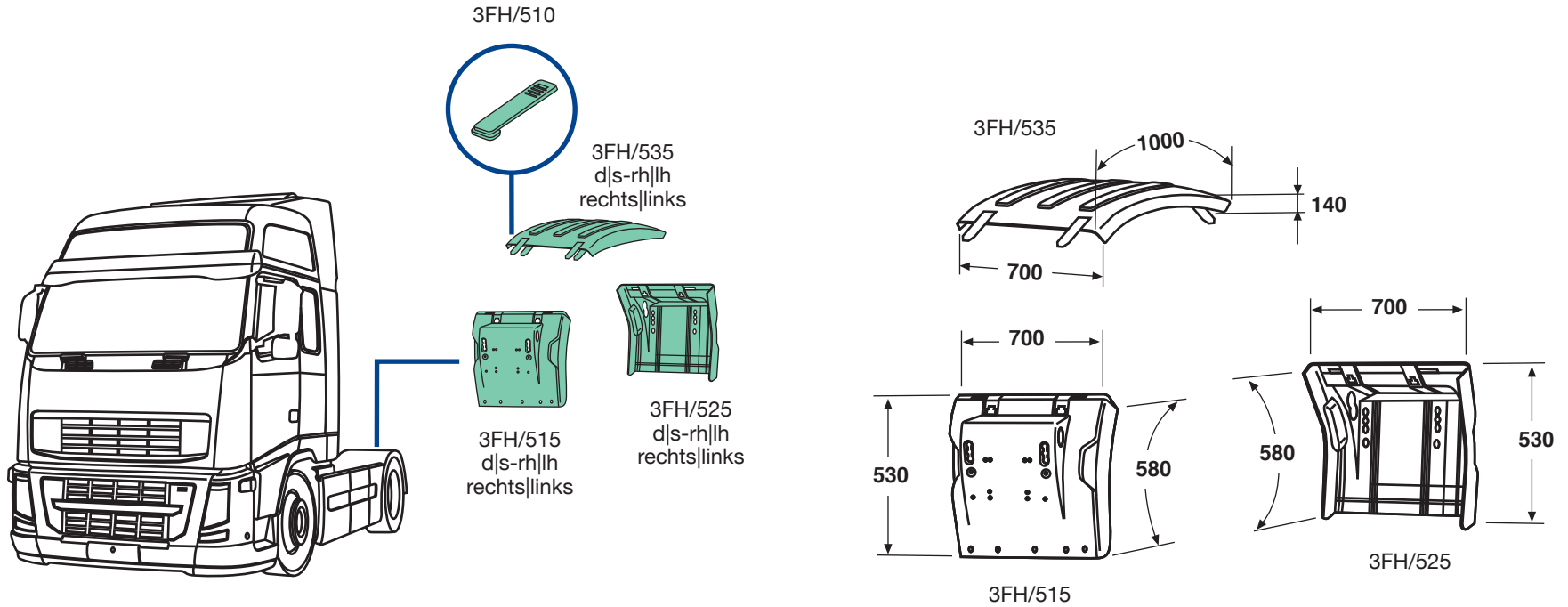

3FH/510
O.E.M. 21094457

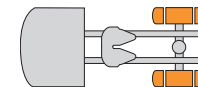

3FH/535
 O.E.M. 21094389
 d|s-rh|lh-rechts|links
 nero, piatta, con cinghietti
 black, flat, with stretchers
 schwarz, flach, mit Spanngummi



3FH/515
 O.E.M. 21094391
 d|s-rh|lh-rechts|links
 nero-black-schwarz

3FH/525
 O.E.M. 21094394
 d|s-rh|lh-rechts|links
 nero, senza anti-spray
 black, without anti-spray
 schwarz, ohne Spritzschutz



applicabile a | suitable to | verwendbar für:

FH13 TERZA SERIE | THIRD SERIES | DRITTE SERIE

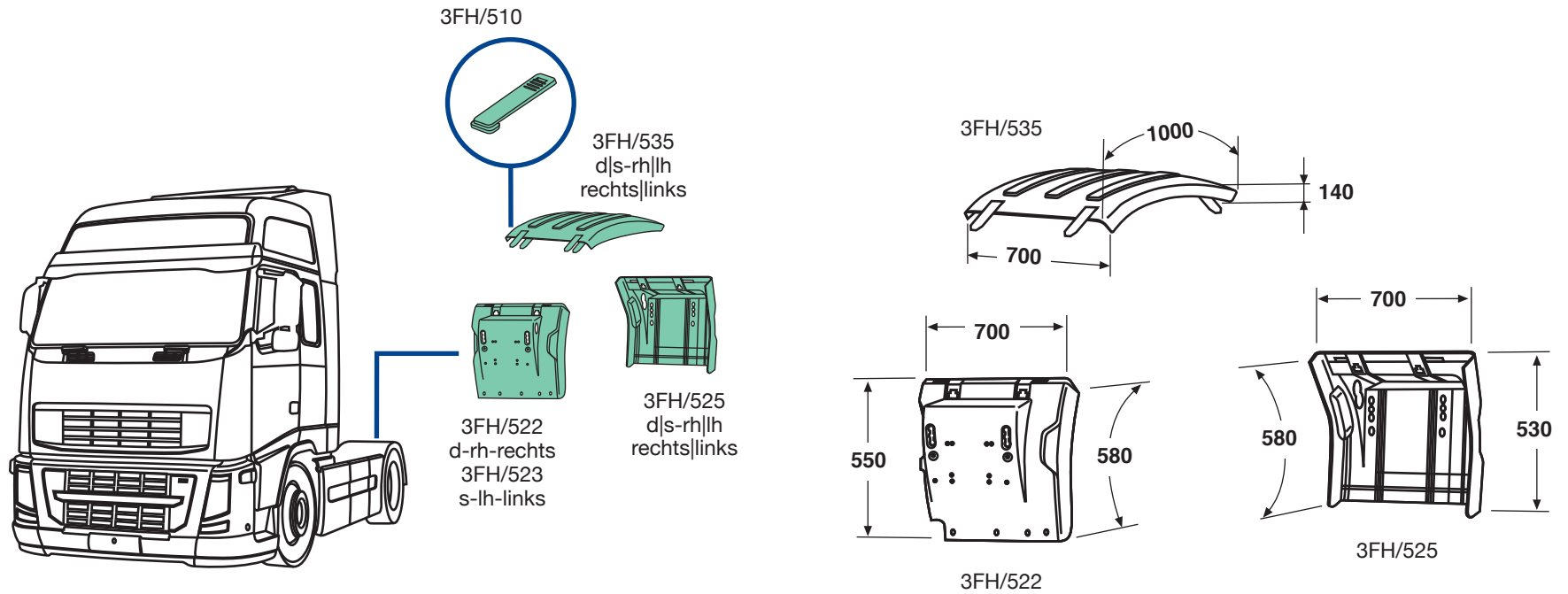

3FH/510
O.E.M. 21094457

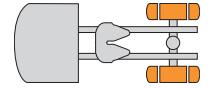

3FH/535
O.E.M. 21094389
d|s-rh||h-rechts|links
nero, piatta, con cinghietti
black, flat, with stretchers
schwarz, flach, mit Spanngummi



3FH/522
O.E.M. 21094392
d-rh-rechts
nero-black-schwarz

3FH/525
O.E.M. 21094394
d|s-rh||h-rechts|links
nero, senza anti-spray
black, without anti-spray
schwarz, ohne Spritzschutz



3FH/535



3FH/525

3FH/523
O.E.M. 21094393
s-lh-links
nero-black-schwarz

FH13 TERZA SERIE | THIRD SERIES | DRITTE SERIE



- 2FH/515
d|s-rh|lh
rechts|links
- 2FH/520
d|s-rh|lh
rechts|links
- 2FH/518
d|s-rh|lh
rechts|links
con staffe
(2FH/517 2 pz.)
anteriore|posteriore
with brackets
front|rear
mit Klemme
Vorderteil|Hinterteil
- 2FH/505
d|s-rh|lh
rechts|links
senza staffe
anteriore|posteriore
without brackets
front|rear
ohne Klemme
Vorderteil|Hinterteil

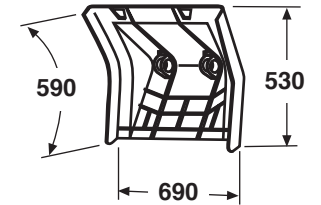
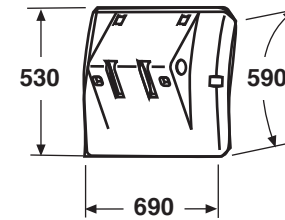
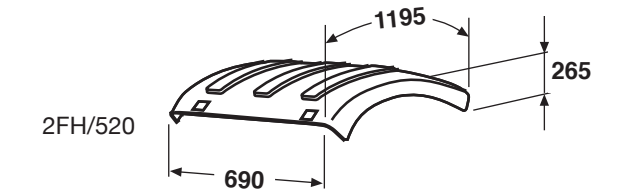
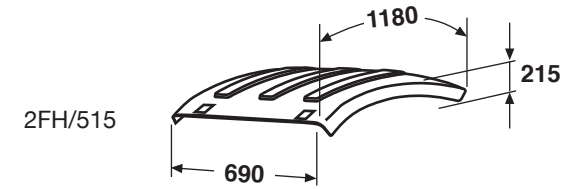

2FH/505

2FH/518

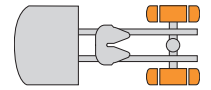

2FH/515
 O.E.M. 20936759
 d|s-rh|lh-rechts|links
 nero, semipiatta, senza cinghietti
 black, semi-flat, without stretchers
 schwarz, halbflach, ohne Spanngummi



2FH/505
 O.E.M. 20392544
 d|s-rh|lh-rechts|links
 nero, senza staffe
 black, without brackets
 schwarz, ohne Klemme

2FH/518
 O.E.M. 20392599
 d|s-rh|lh-rechts|links
 nero, senza anti-spray, con staffe
 black, without anti-spray, with brackets
 schwarz, ohne Spritzschutz, mit Klemme



2FH/520
 O.E.M. 20936769
 d|s-rh|lh-rechts|links
 nero, circolare, senza cinghietti
 black, circular, without stretchers
 schwarz, kreisförmig, ohne Spanngummi



2FH/518

2FH/505

applicabile a | suitable to | verwendbar für:

FH13 TERZA SERIE | THIRD SERIES | DRITTE SERIE

adattabile a: - suitable to: - passend für:

(*) 3FH/515

(°) 3FH/522-3FH/523

(**) 3FH/315-3FH/525

3FH/527(*)

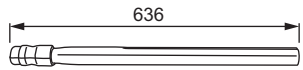

3FH/528(°)

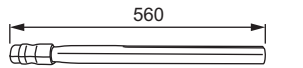

3FH/532(**)

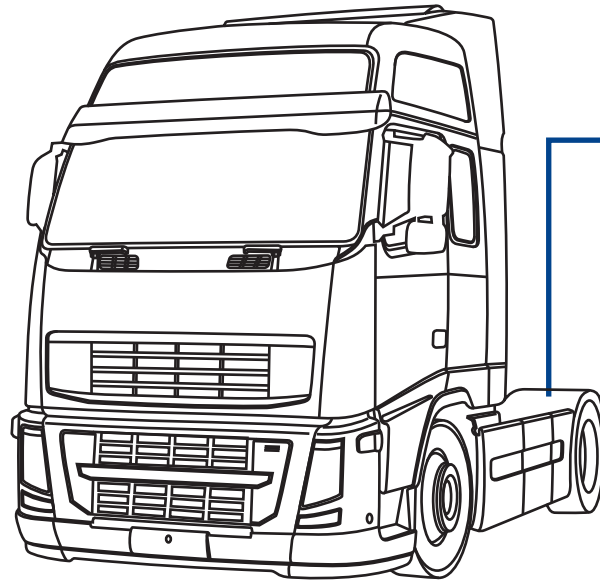
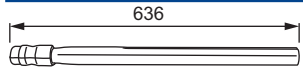

3FH/527(*)
d|s-rh|lh-rechts|links
3FH/528(°)
d|s-rh|lh-rechts|links
3FH/532(**)
d|s-rh|lh-rechts|links

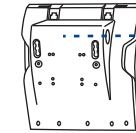

3FH/526
d|s-rh|lh
rechts|links



3FH/526
O.E.M. 21094456 + 21094454



3FH/527
O.E.M. 22192010
3FH/528
O.E.M. 22192007



3FH/532
O.E.M. 22192015

adattabile a: - suitable to: - passend für:
(*) 2FH/505

FH13 TERZA SERIE | THIRD SERIES | DRITTE SERIE

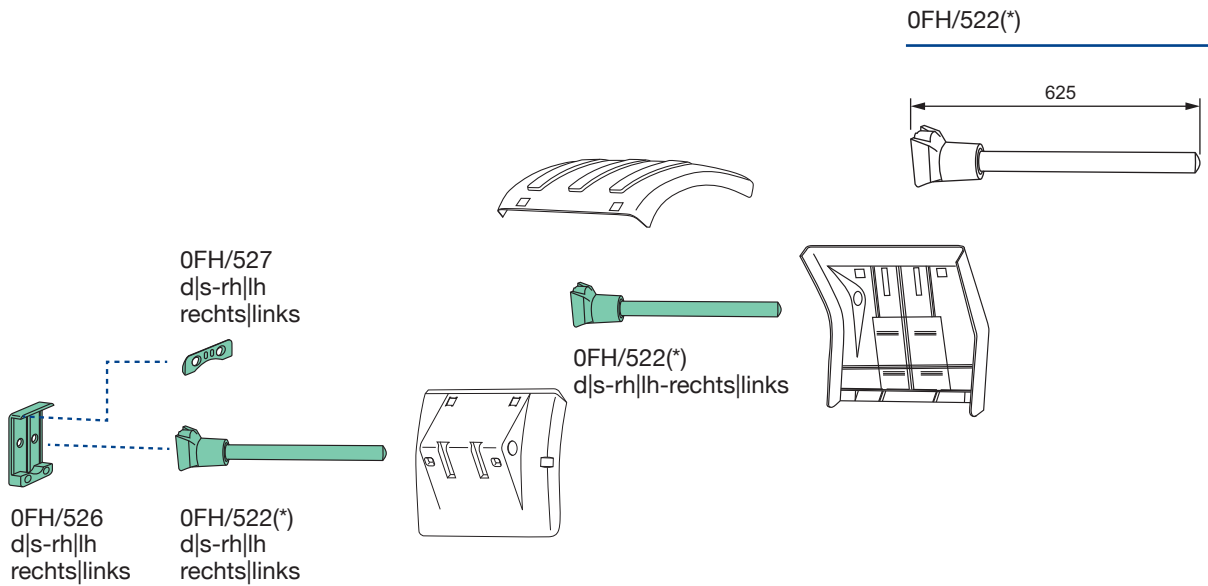
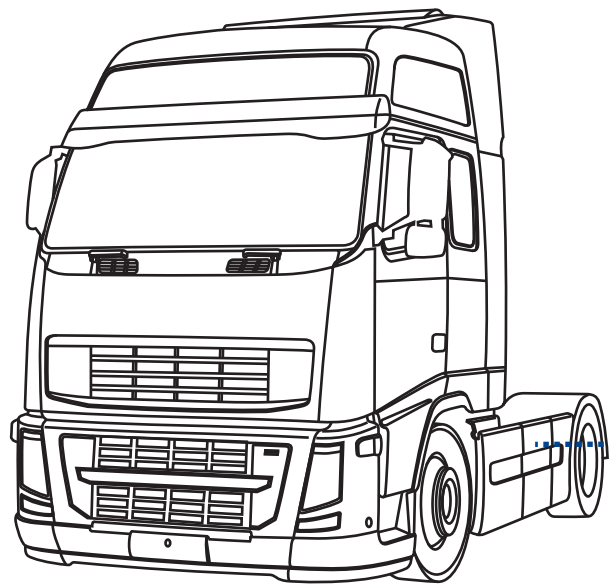

0FH/522
O.E.M. 20466894



0FH/526
O.E.M. 20382890



0FH/527
O.E.M. 20383038

applicabile a | suitable to | verwendbar für:

FH13 TERZA SERIE | THIRD SERIES | DRITTE SERIE

adattabile a - suitable to: - passend für:

(*) 2FH/510

(°) PRM/515

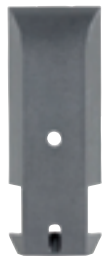
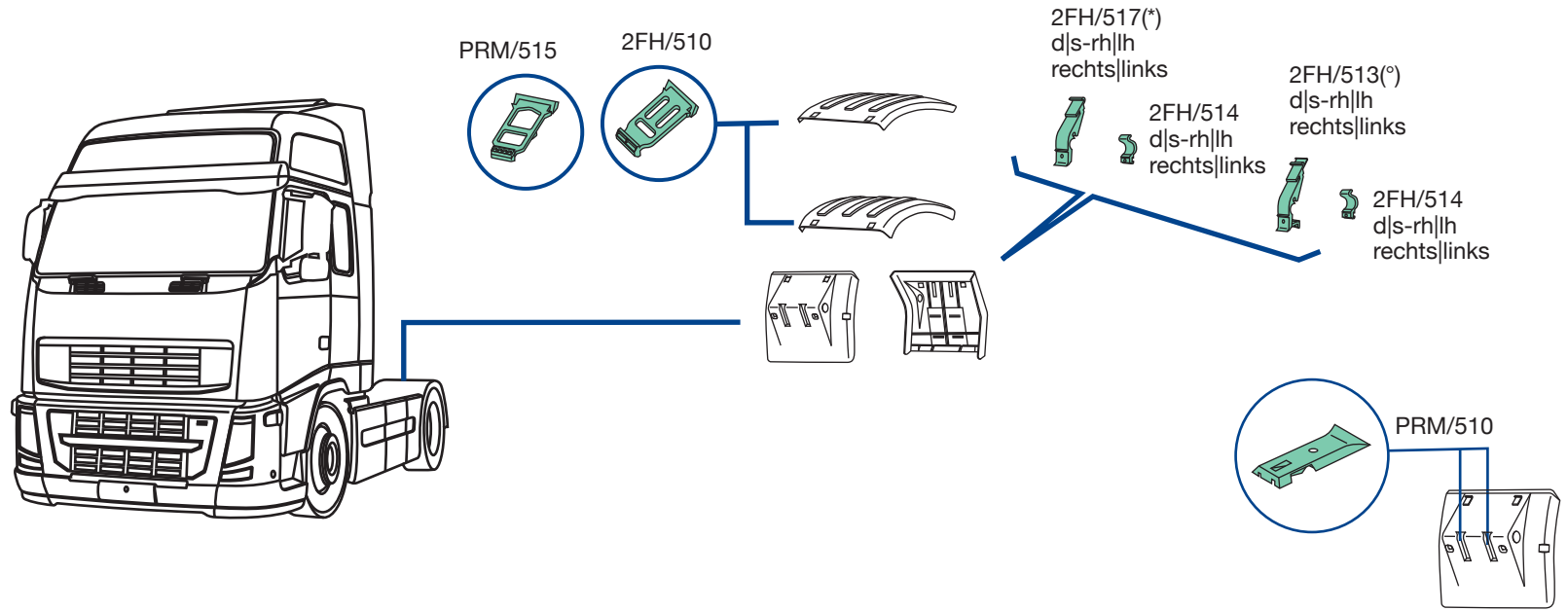

PRM/510
O.E.M. 20721840



PRM/515
O.E.M. 20498623



2FH/510
O.E.M. 1079981



2FH/513
O.E.M. 20583434

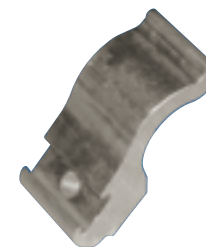

2FH/514
O.E.M. 20583440



2FH/517
O.E.M. 3987252

FH13 TERZA SERIE | THIRD SERIES | DRITTE SERIE



0FH/520
d|s-rh|lh
rechts|links



2FH/528
d|s-rh|lh
rechts|links



2FH/526
d|s-rh|lh
rechts|links

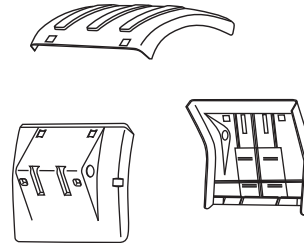

0FH/521
d|s-rh|lh
rechts|links



2FH/528
d|s-rh|lh
rechts|links



2FH/526
d|s-rh|lh
rechts|links

0FH/520

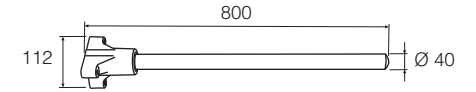

0FH/521

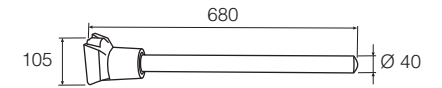

0FH/520
O.E.M. 8154385



0FH/521
O.E.M. 20466895



2FH/526
O.E.M. 21213202



2FH/528
O.E.M. 21090272

applicabile a | suitable to | verwendbar für:

FH13 TERZA SERIE | THIRD SERIES | DRITTE SERIE

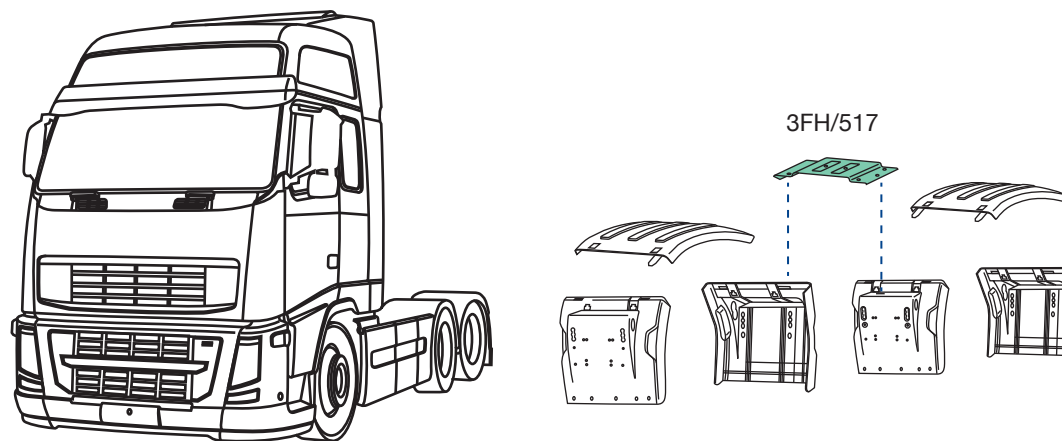

3FH/517
O.E.M. 21094406

PDS/360

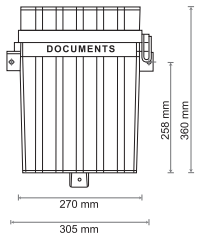

applicabile a | suitable to | verwendbar für:

FH13 TERZA SERIE | THIRD SERIES | DRITTE SERIE

2FH/610 d|s-rh|lh-rechts|links

2002→

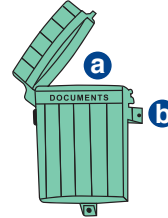
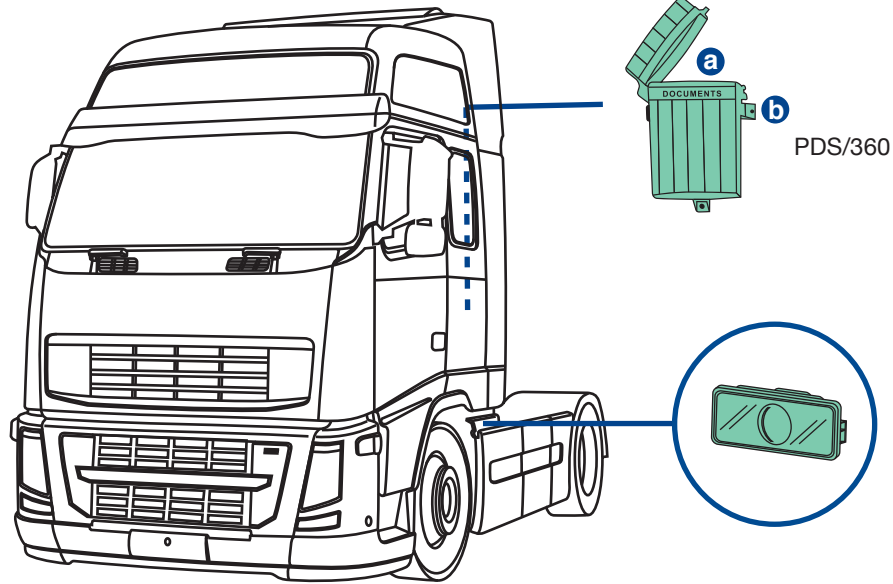

PDS/360

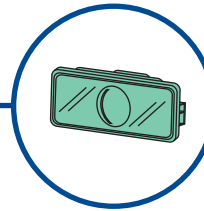

2FH/610
d|s-rh|lh-rechts|links

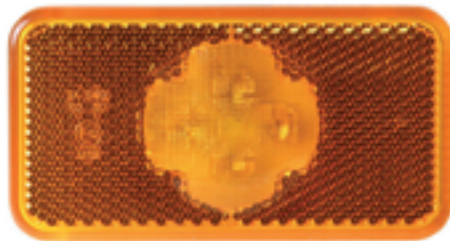
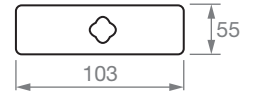

2FH/610
O.E.M. 20789440



PDS/360
O.E.M. -



applicabile a | suitable to | verwendbar für:

FH13 TERZA SERIE | THIRD SERIES | DRITTE SERIE

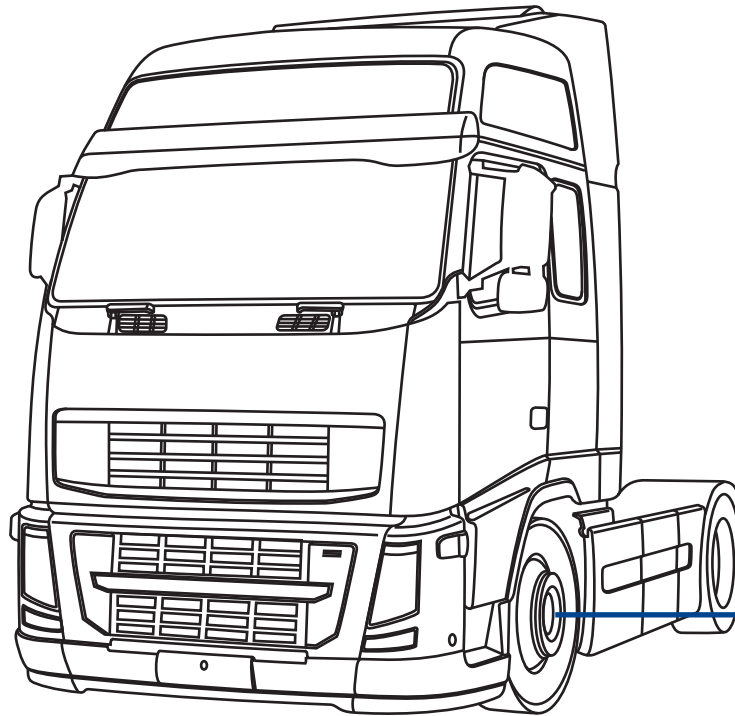

930/033

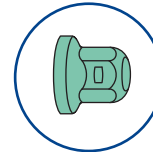

930/200
d|s-rh|lh
rechts|links

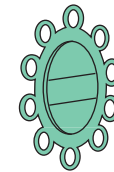

930/100
d-rhrechts
930/101
s-lh-links

930/001
d-rh-rechts
930/002
s-lh-links



930/033
O.E.M. -



930/001
O.E.M. -
930/002
O.E.M. -



930/100
O.E.M. -
930/101
O.E.M. -



930/200
O.E.M. -

FH13 TERZA SERIE | THIRD SERIES | DRITTE SERIE

930/033-Tappo copri Bullone-Bolt cover-Radmutterkappen

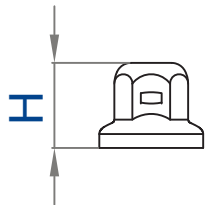

H	45 mm
Per bulloni \varnothing - bolt \varnothing	33 mm
Schlüsselweite \varnothing	
Colore	cromato-chrome-verchromt
Colours-Farbe	
Materiale-Material	acciaio inox-stainless steel Edelstahl
Kg	0,025

930/001 d-rh-rechts | 930/002 s-lh-links

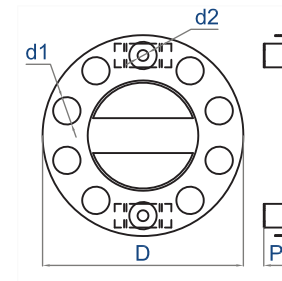

D \varnothing 425 mm	P 50 mm
d1 nr. 10	d1 \varnothing 58 mm
d2 nr. 2	d2 \varnothing 23 mm
Ventilata	si-yes-Ja
Ventilated-Belüftet	
Colore	cromato e nero-chrome and black
Colours-Farbe	verchromt und schwarz
Materiale-Material	acciaio inox e plastica stainless steel and plastic Edelstahl und Kunststoff
Kg	1,230

930/100 d-rh-rechts | 930/101 s-lh-links

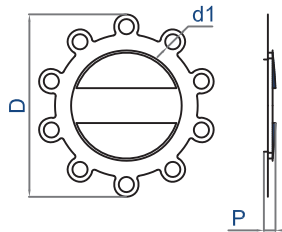

D \varnothing 387 mm	P 30 mm
d1 nr. 10	d1 \varnothing 32 mm
Ventilata	si-yes-Ja
Ventilated-Belüftet	
Colore	cromato e nero-chrome and black
Colours-Farbe	verchromt und schwarz
Materiale-Material	acciaio inox e plastica stainless steel and plastic Edelstahl und Kunststoff
Kg	0,655

930/200 d|s-rh|lh-rechts+links

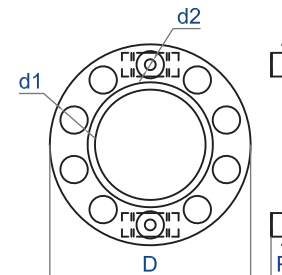

D \varnothing 425 mm	P 40 mm
d1 nr. 10	d1 \varnothing 58 mm
d2 nr. 2	d2 \varnothing 23 mm
Ventilata	no-nein
Ventilated-Belüftet	
Colore	cromato-chrome-verchromt
Colours-Farbe	
Materiale-Material	acciaio inox-stainless steel Edelstahl
Kg	1,155

applicabile a | suitable to | verwendbar für:

FH13 TERZA SERIE | THIRD SERIES | DRITTE SERIE

0FH/675

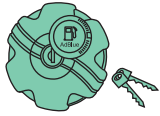

XF0/670

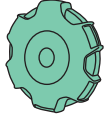

943/670

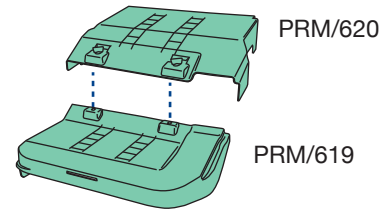
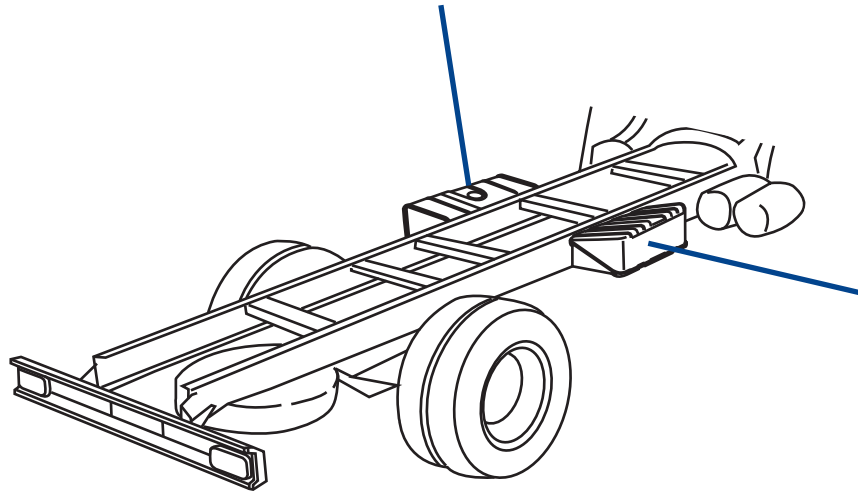
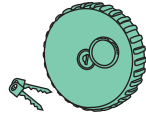

PRM/620

PRM/619

0FH/675

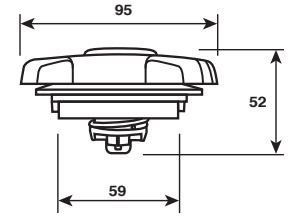

XF0/670

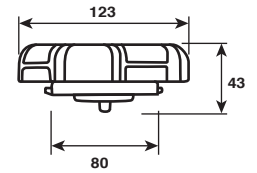

943/670

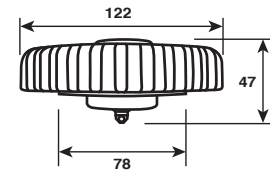

0FH/675
O.E.M. 21281403



XF0/670
O.E.M. -



943/670
O.E.M. 20392752



PRM/619
O.E.M. 23417998



PRM/620
O.E.M. 23417997



applicabile a | suitable to | verwendbar für

245

2FH
FH12-FH16
(2002→2007)

SECONDA SERIE | SECOND SERIES | ZWEITE SERIE

I codici originali sono riportati unicamente per favorire l'identificazione del prodotto | The original codes are indicated for product identification only | Die aufgeführten Originalnummer dienen ausschließlich zu Vergleichszwecken

gallery

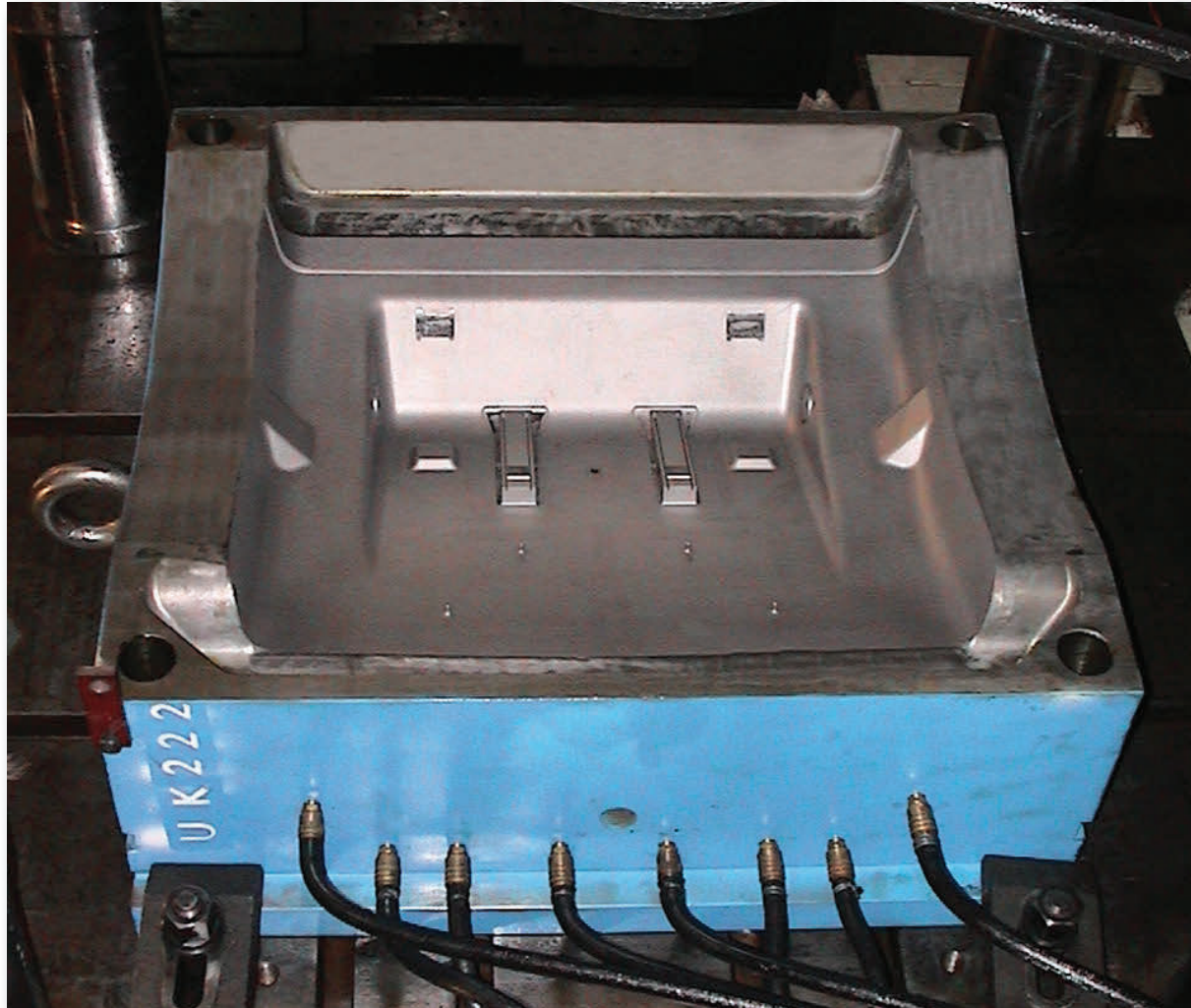

(*) Cava-Cantiere
Yard & Quarry
Baustellenfahrzeug

FH12-FH16 SECONDA SERIE | SECOND SERIES | ZWEITE SERIE

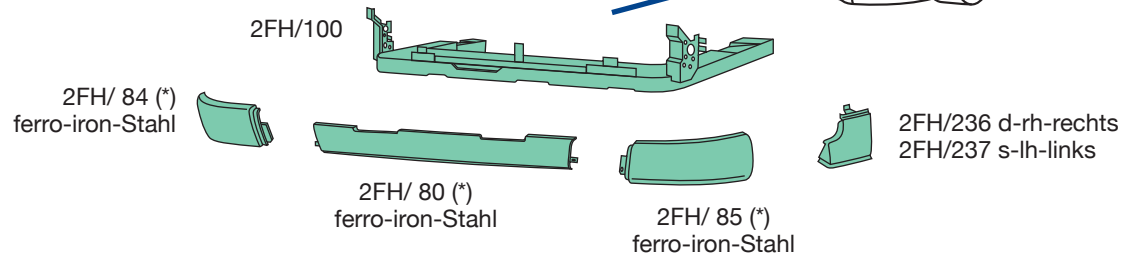
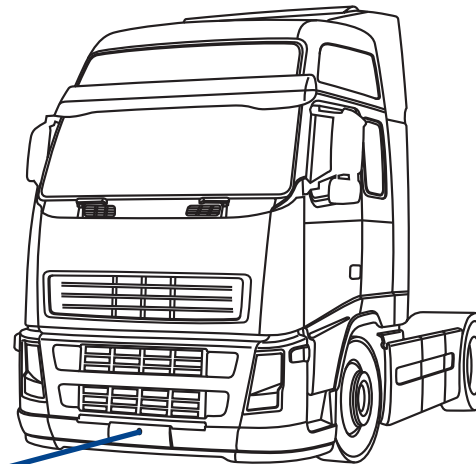

2FH/ 80
O.E.M. 21828914



2FH/ 84
O.E.M. 21829052
2FH/ 85
O.E.M. 21829051



2FH/100
O.E.M. 21484901



2FH/236
O.E.M. 20453677
2FH/237
O.E.M. 20453676

applicabile a | suitable to | verwendbar für:

FH12-FH16 SECONDA SERIE | SECOND SERIES | ZWEITE SERIE

(*) grezzo
unprocessed
roh
(°) verniciato grigio scuro
dark grey painted
dunkel grau strukturlackiert

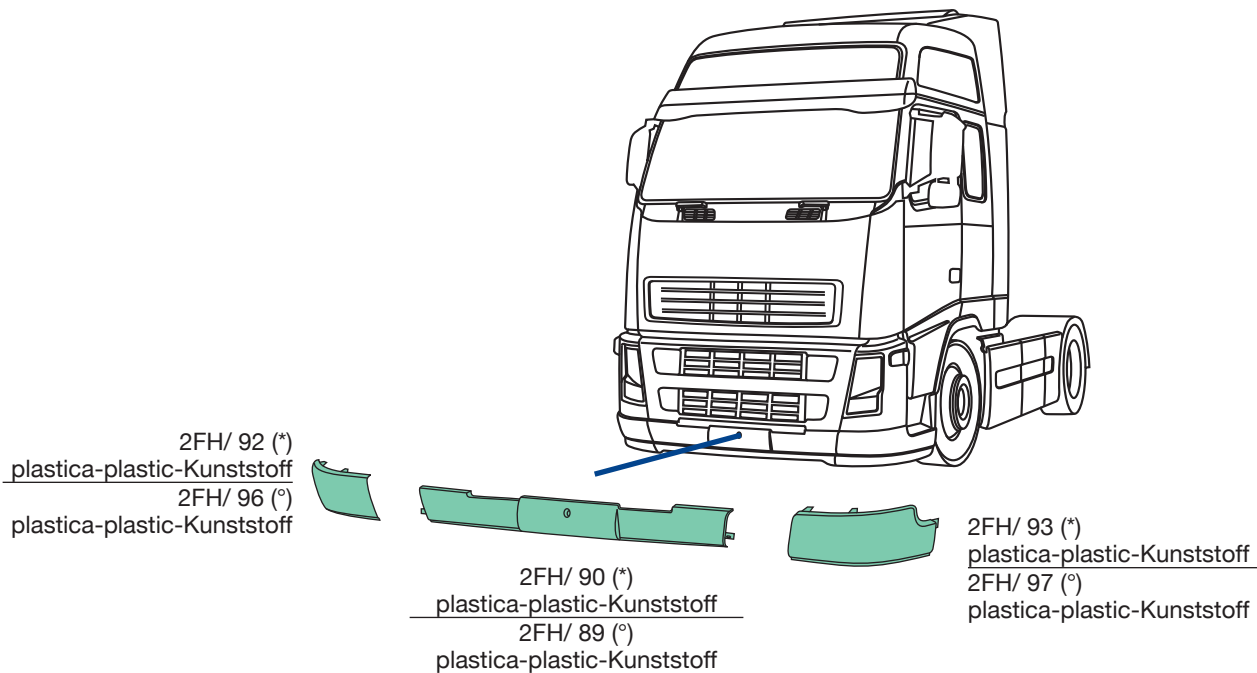

2FH/ 89
O.E.M. 20529740



2FH/ 90
O.E.M. 21359080



2FH/ 92
O.E.M. 21359090
2FH/ 93
O.E.M. 21359082



2FH/ 96
O.E.M. 20529742
2FH/ 97
O.E.M. 20529741

FH12-FH16 SECONDA SERIE | SECOND SERIES | ZWEITE SERIE

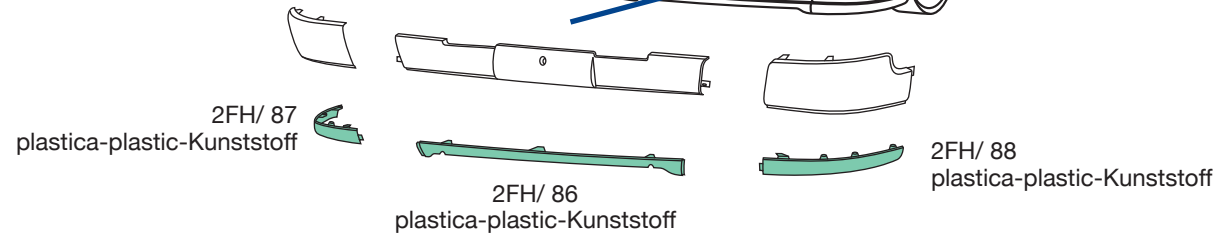
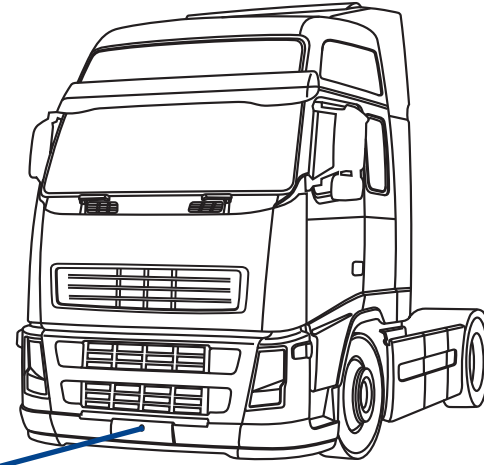

2FH/ 86
O.E.M. 21430599

2FH/ 87
O.E.M. 21430672
2FH/ 88
O.E.M. 21430600

applicabile a | suitable to | verwendbar für:

FH12-FH16 | SECONDA SERIE | SECOND SERIES | ZWEITE SERIE

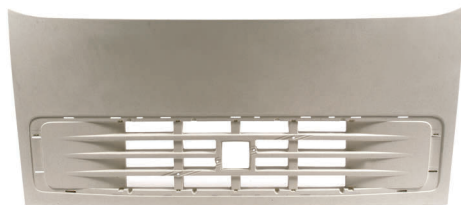
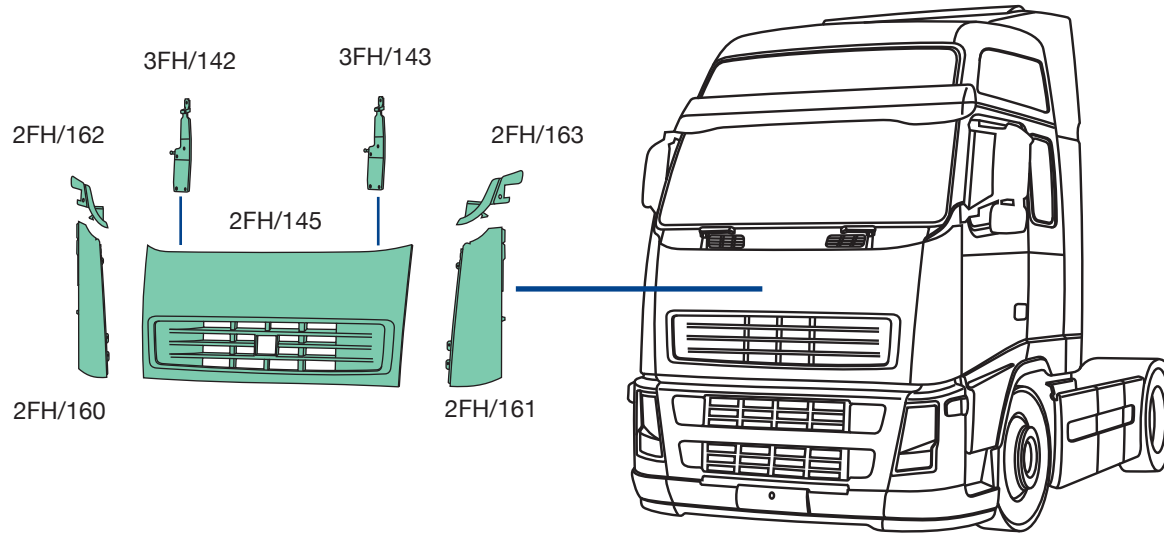

2FH/145
O.E.M. 20360266



3FH/142
O.E.M. 82215401
3FH/143
O.E.M. 82215391



2FH/160
O.E.M. 20379176
2FH/161
O.E.M. 20379175



2FH/162
O.E.M. 20529672
2FH/163
O.E.M. 20529668

FH12-FH16 SECONDA SERIE | SECOND SERIES | ZWEITE SERIE

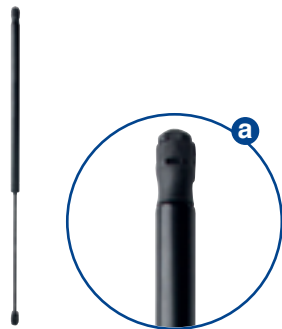
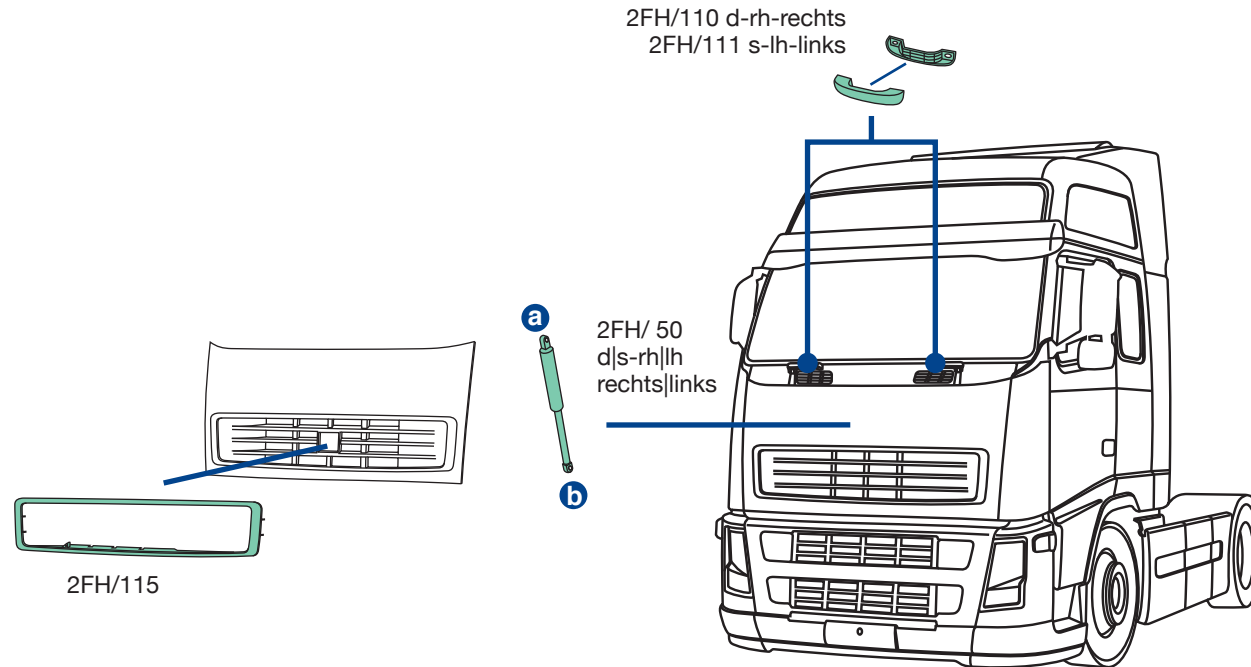

2FH/ 50
O.E.M. 20379348



2FH/110
O.E.M. 3175367+3175366
2FH/111
O.E.M. 20383543+3175366



2FH/115
O.E.M. 20467053

applicabile a | suitable to | verwendbar für:

FH12-FH16 | SECONDA SERIE | SECOND SERIES | ZWEITE SERIE

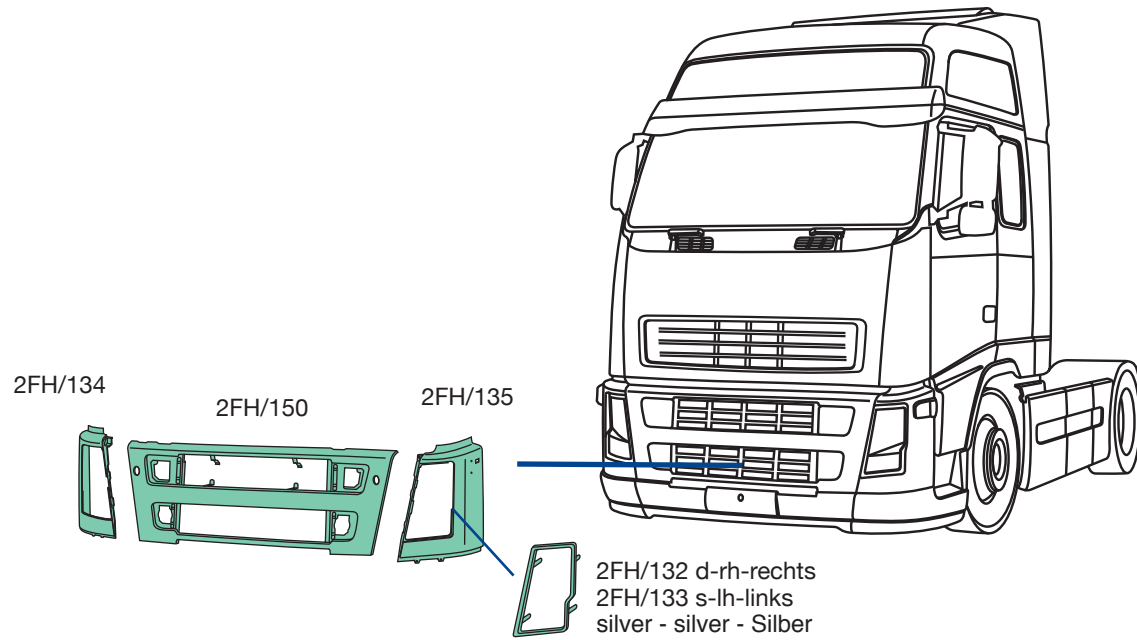

2FH/132
O.E.M. 20452848
2FH/133
O.E.M. 20452847



2FH/134
O.E.M. 21469924
2FH/135
O.E.M. 21469918



2FH/150
O.E.M. 21430596

2FH/606 d-rh-rechts | 2FH/607 s-lh-links 2002→2007

FH12-FH16 SECONDA SERIE | SECOND SERIES | ZWEITE SERIE

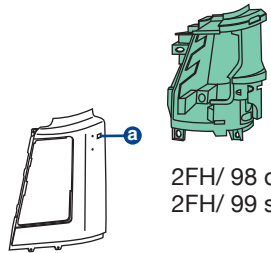
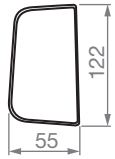
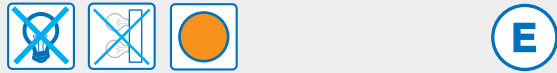

2FH/ 98 d-rh-rechts
2FH/ 99 s-lh-links



2FH/ 94 d-rh-rechts
2FH/ 95 s-lh-links

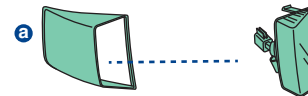

2FH/136 d-rh-rechts
2FH/137 s-lh-links



2FH/606 d-rh-rechts
2FH/607 s-lh-links



2FH/ 94
O.E.M. 21359260
2FH/ 95
O.E.M. 21359257



2FH/ 98
O.E.M. 20917958
2FH/ 99
O.E.M. 20917957



2FH/136
O.E.M. 21469979
2FH/137
O.E.M. 21430598



2FH/606
O.E.M. 20826213
2FH/607
O.E.M. 20826211



applicabile a | suitable to | verwendbar für:

FH12-FH16 SECONDA SERIE | SECOND SERIES | ZWEITE SERIE

2FH/602 d-rh-rechts | 2FH/603 s-lh-links 2002→2007



2FH/604 d-rh-rechts | 2FH/605 s-lh-links 2002→2007



2FH/602 d-rh-rechts
2FH/603 s-lh-links
2FH/604 d-rh-rechts
2FH/605 s-lh-links

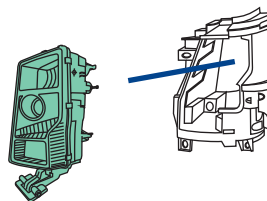

12 pins



2FH/602
O.E.M. 21001649
2FH/603
O.E.M. 21001645



9 pins



2FH/604
O.E.M. 21001668
2FH/605
O.E.M. 21001663

FH12-FH16 SECONDA SERIE | SECOND SERIES | ZWEITE SERIE

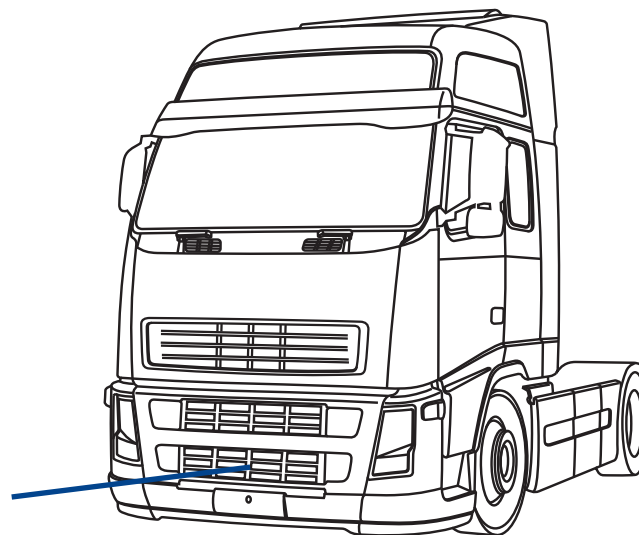
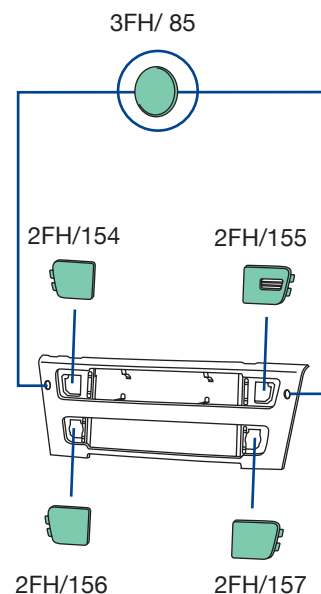

2FH/154
O.E.M. 20529706



2FH/155
O.E.M. 20529705



2FH/156
O.E.M. 20529708
2FH/157
O.E.M. 20529707



3FH/ 85
O.E.M. 21425186

applicabile a | suitable to | verwendbar für:

FH12-FH16 SECONDA SERIE | SECOND SERIES | ZWEITE SERIE

(*) >2007 singole-singles-Einzelteil
2007> 2FH/152 + 2FH/153 (in coppia-a pair of-Paar)

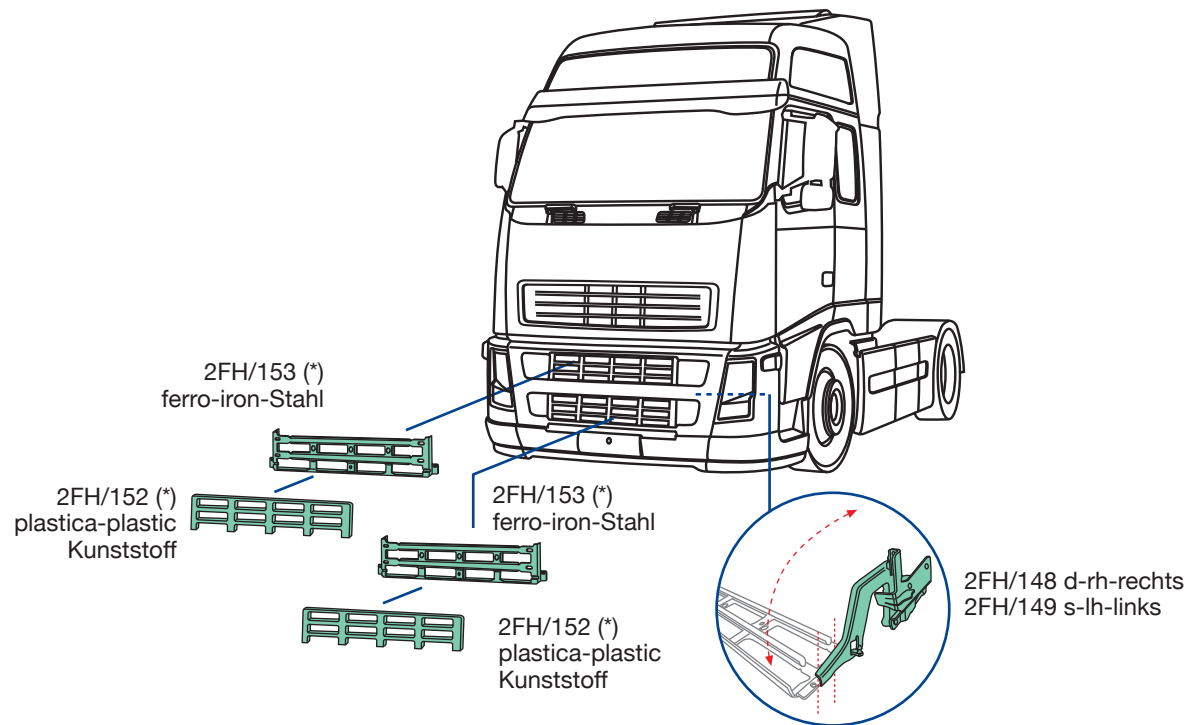

2FH/148
O.E.M. 20545095
2FH/149
O.E.M. 20545094



2FH/152
O.E.M. 20409818



2FH/153
O.E.M. 20456963

2FH/400 20456709

materiale | material | material PMMA - Acrylglas

peso | weight | Gewicht 1,920 Kg

applicabilità | suitable to | für VOLVO 2FH. FH II 2002→2008
VOLVO 2FM. FM II 2002→2008

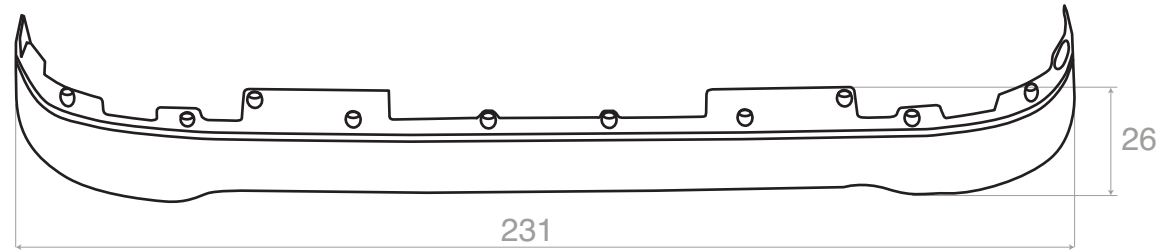

(cm)

extra



2FH/410 20527443



2FH/480

20467422
20467412
20467414
20467424



GOVIND

applicabile a | suitable to | verwendbar für:

FH12-FH16 SECONDA SERIE | SECOND SERIES | ZWEITE SERIE

2FH/ 6 d-rh-rechts
2FH/ 7 s-lh-links

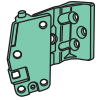

2FH/ 9
d|s-rh|lh
rechts|links

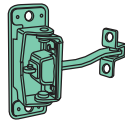

2FH/ 10
d|s-rh|lh
rechts|links

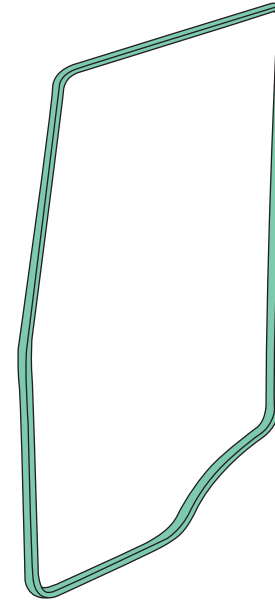
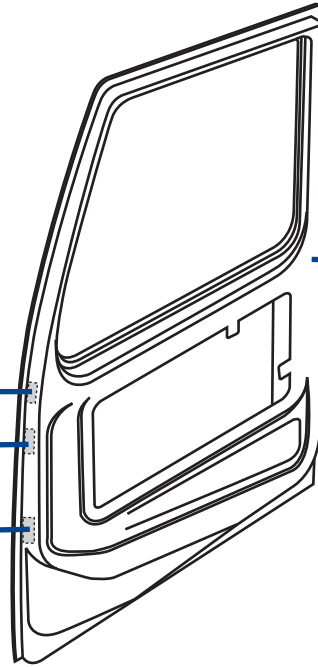
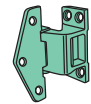

0FH/190

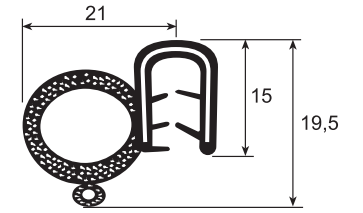

0FH/190



2FH/ 6
O.E.M. 20398136
2FH/ 7
O.E.M. 20398135

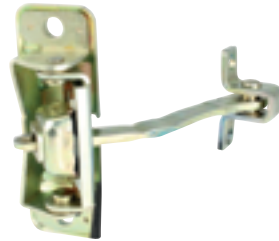

2FH/ 9
O.E.M. 1062636



2FH/ 10
O.E.M. 20372039



0FH/190
O.E.M. 3175029

FH12-FH16 SECONDA SERIE | SECOND SERIES | ZWEITE SERIE

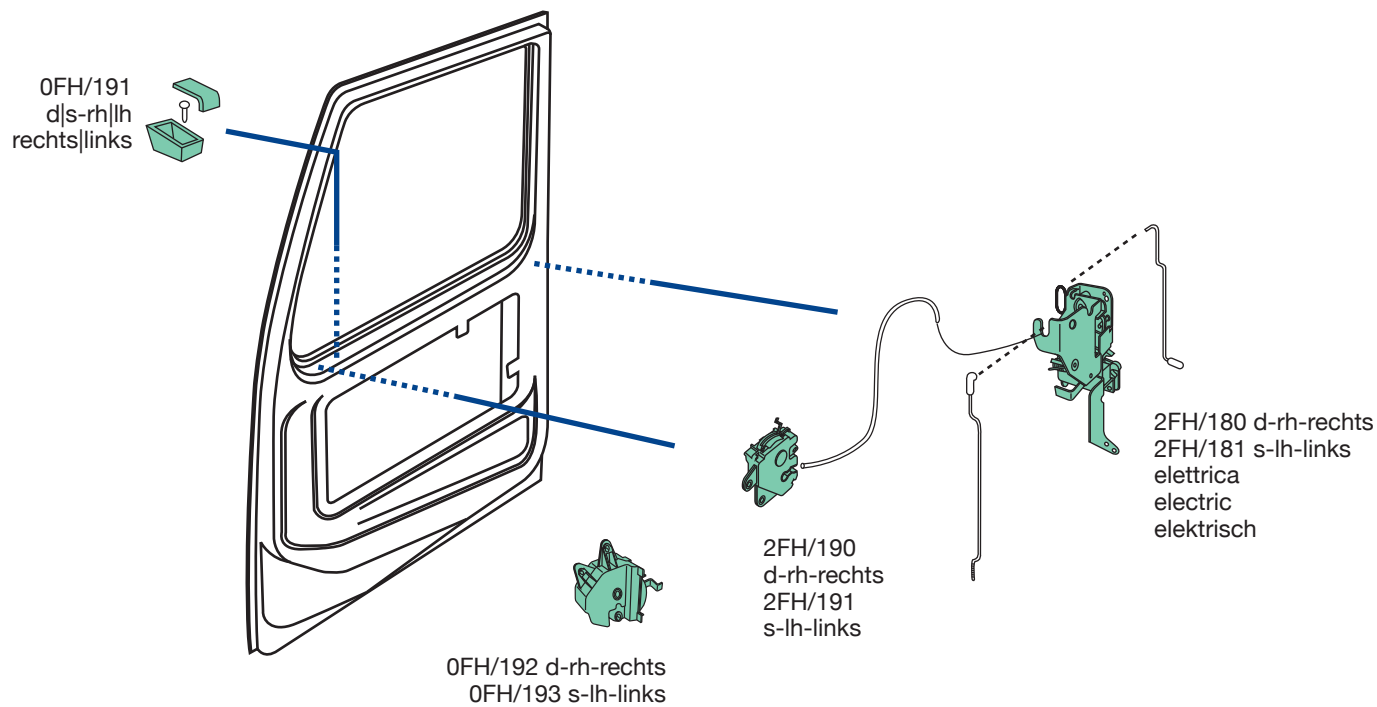

0FH/191
O.E.M. 20379593



0FH/192
O.E.M. 1063328
0FH/193
O.E.M. 1063327



2FH/180
O.E.M. 21505894
2FH/181
O.E.M. 21505893



2FH/190
O.E.M. 20570722
2FH/191
O.E.M. 20570721

applicabile a | suitable to | verwendbar für:

FH12-FH16

SECONDA SERIE | SECOND SERIES | ZWEITE SERIE

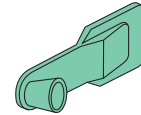
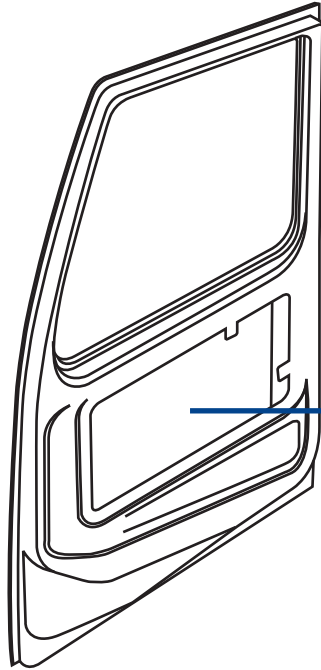

0FH/166
d|s-rh||h-rechts|links

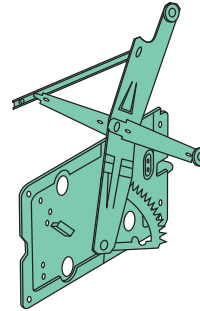

0FM/174 d-rh-rechts
0FM/175 s-lh-links
elettrico, senza motorino
electric, without motor
elektrisch, ohne Motor



0FH/166
O.E.M. 3953182



0FM/174
O.E.M. -
0FM/175
O.E.M. -

FH12-FH16 SECONDA SERIE | SECOND SERIES | ZWEITE SERIE

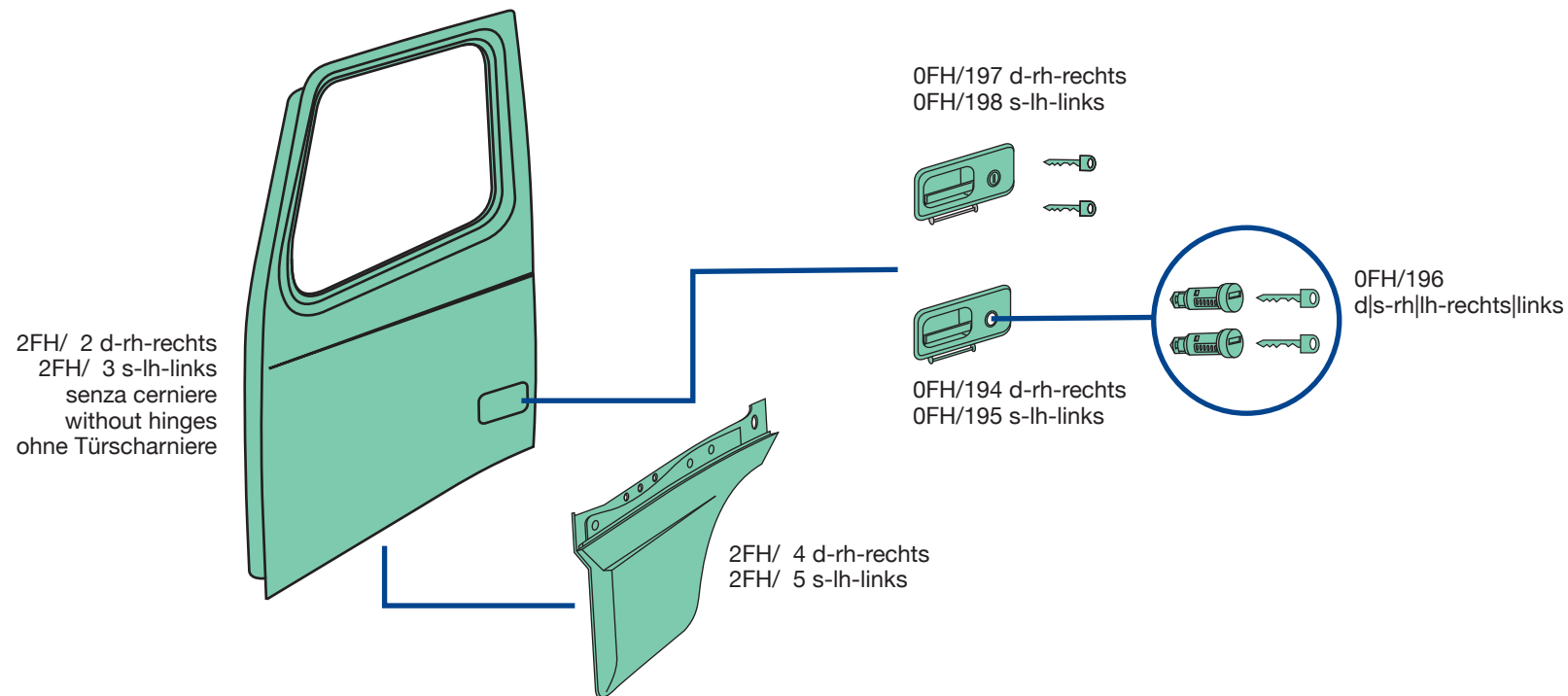

0FH/194
O.E.M. 20398467
0FH/195
O.E.M. 20398466



0FH/196
O.E.M. 3090484



0FH/197
O.E.M. -
0FH/198
O.E.M. -



2FH/ 2
O.E.M. 20360543
2FH/ 3
O.E.M. 20360542



2FH/ 4
O.E.M. 21300059
2FH/ 5
O.E.M. 21299955

applicabile a | suitable to | verwendbar für:



FH12-FH16 SECONDA SERIE | SECOND SERIES | ZWEITE SERIE

3FH/502

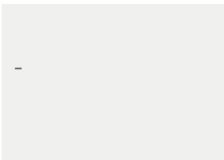

II (E4) 024111
200x435 mm



IV (E4) 024112
176x188 mm

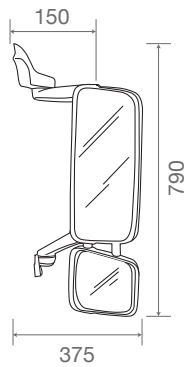

applicabilità:
applicable to:
Verwendbar für

VOLVO 2FH. FH II 2002→
VOLVO 2FM. FM II 2002→

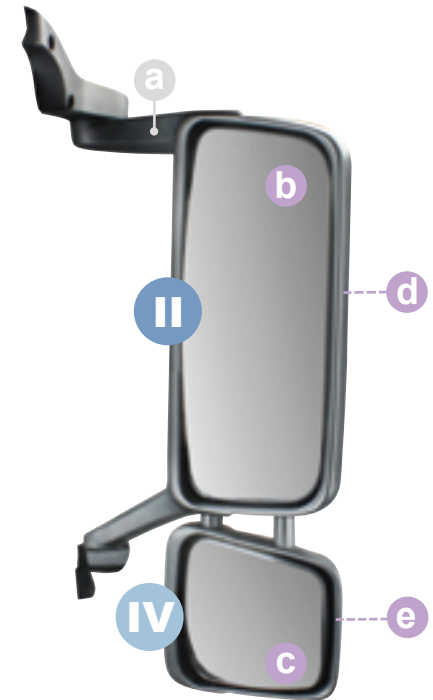

COVIND II
2FH/500
IV

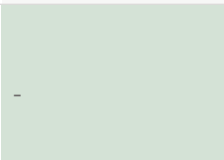

249x231 mm

a

-

-

b

2FH/503

 21320404
(20589788)

 E4 024111
200x435 mm

II

c

2FH/504

 21320300
(20567685)
(20455995)

 E4 024112
176x188 mm

IV

d

2FH/502

 20746401
(20360810)

187x435 mm

II

e

2FH/508

20360811



250x200 mm

IV

applicabile a | suitable to | verwendbar für:



FH12-FH16 SECONDA SERIE | SECOND SERIES | ZWEITE SERIE

3FH/503



II

E4 024111

200x435 mm



IV

E4 024112

176x188 mm

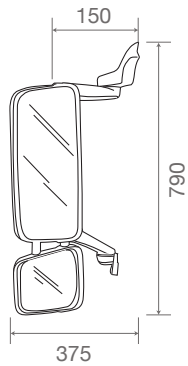

applicabilità:
applicable to:
Verwendbar für

VOLVO 2FH. FH II 2002→
VOLVO 2FM. FM II 2002→

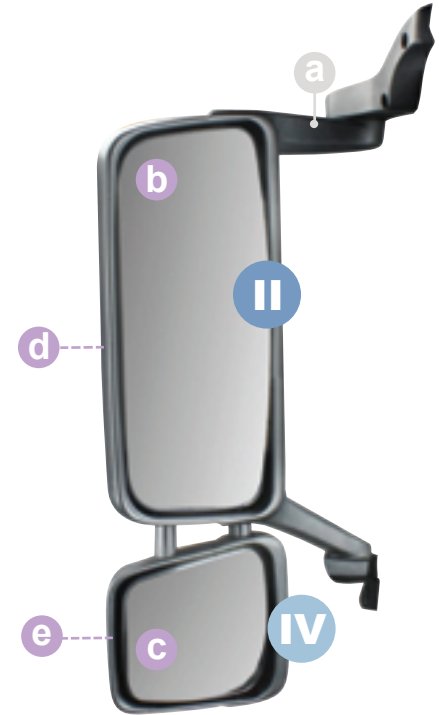

COVIND II
IV

2FH/501



250x235 mm

a

-

b

2FH/503

21320404
(20589788)

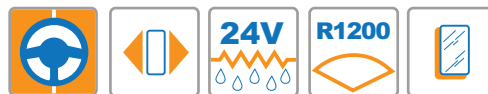

(E4) 024111

200x435 mm

II

c

2FH/504

21320300
(20567685)
(20455995)



(E4) 024112

176x188 mm

IV

d

2FH/502

20746401
(20360810)



187x435 mm

II

e

2FH/508

20360811



250x200 mm

IV

applicabile a | suitable to | verwendbar für:

FH12-FH16 | SECONDA SERIE | SECOND SERIES | ZWEITE SERIE

2FH/506

20854644
(1096643)

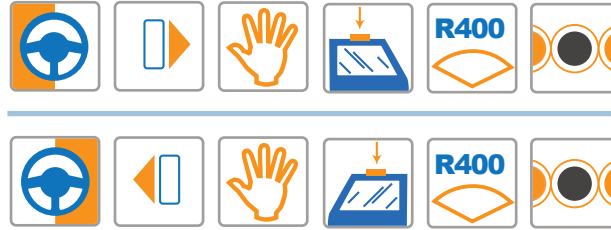

V E9 026322
275x165 mm

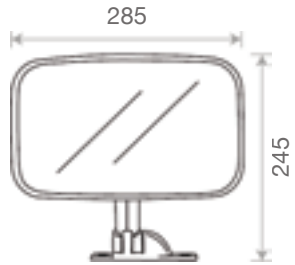

applicabilità:
applicable to:
Verwendbar für

VOLVO 0FH. FH I
VOLVO 2FH. FH II
VOLVO 0FM. FM I
VOLVO 2FM. FM II



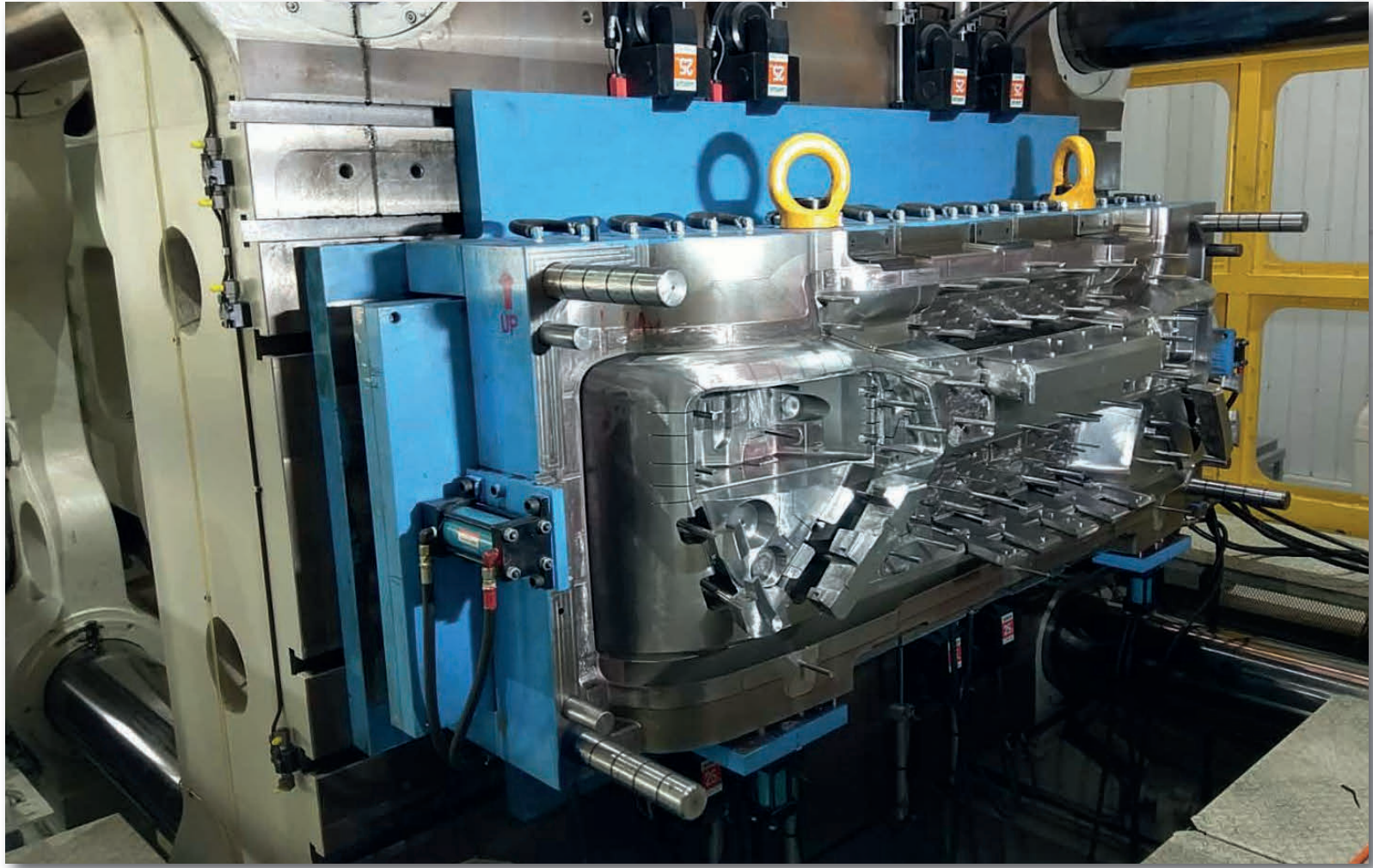

applicabile a | suitable to | verwendbar für:

FH12-FH16 | SECONDA SERIE | SECOND SERIES | ZWEITE SERIE

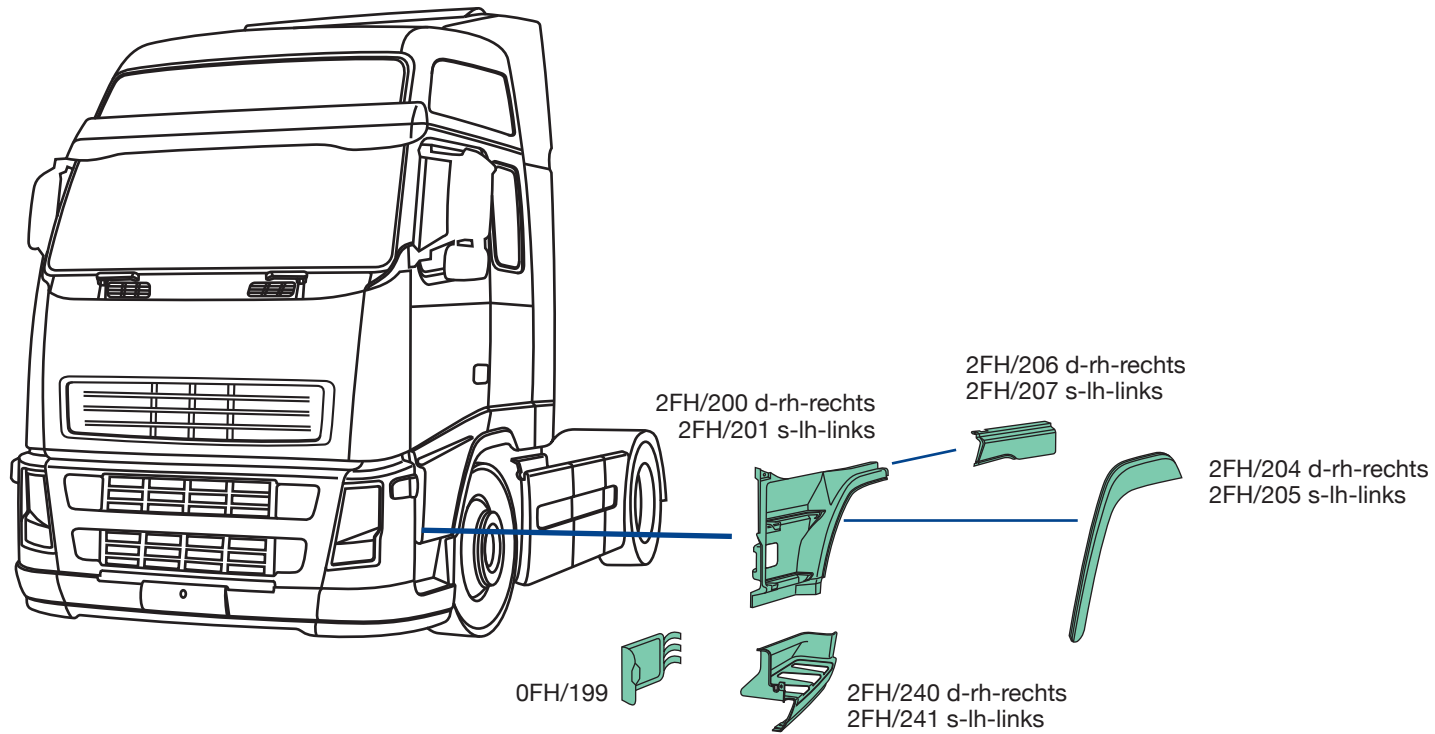

0FH/199
O.E.M. 20529765



2FH/200
O.E.M. 3175928
2FH/201
O.E.M. 3175927



2FH/204
O.E.M. 20529684
2FH/205
O.E.M. 20529682



2FH/206
O.E.M. 21302470
2FH/207
O.E.M. 21302461



2FH/240
O.E.M. 20529640
2FH/241
O.E.M. 20529638

FH12-FH16 SECONDA SERIE | SECOND SERIES | ZWEITE SERIE

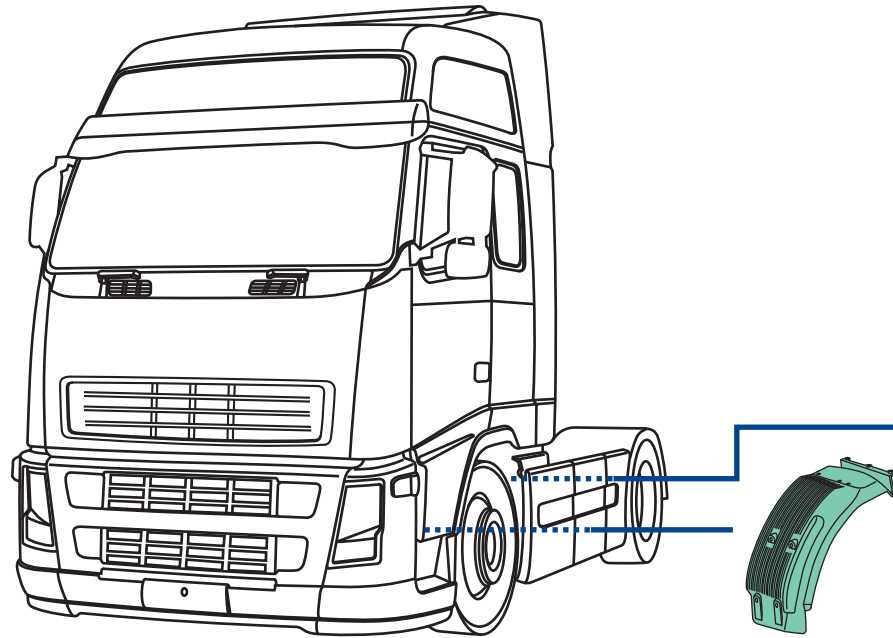

2FH/316 d-rh-rechts
2FH/317 s-lh-links

2FH/325
d|s-rh|lh
rechts|links

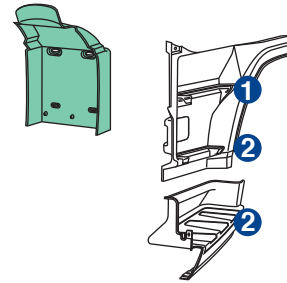

1 0FH/210
d|s-rh|lh-rechts|links

2 2FH/208 d-rh-rechts
2FH/209 s-lh-links



0FH/210
O.E.M. 20379439



2FH/208
O.E.M. 20360789
2FH/209
O.E.M. 20360788



2FH/316
O.E.M. 20372065
2FH/317
O.E.M. 20372064



2FH/325
O.E.M. 20453900

FH12-FH16 SECONDA SERIE | SECOND SERIES | ZWEITE SERIE

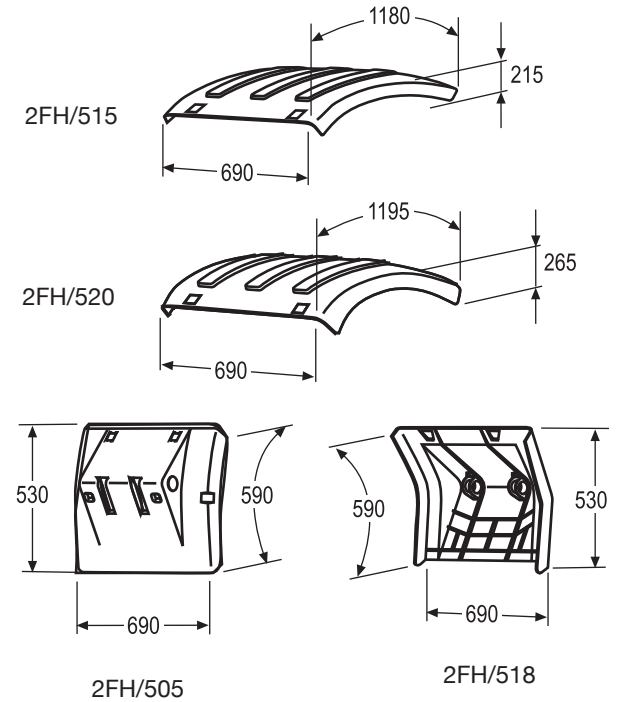
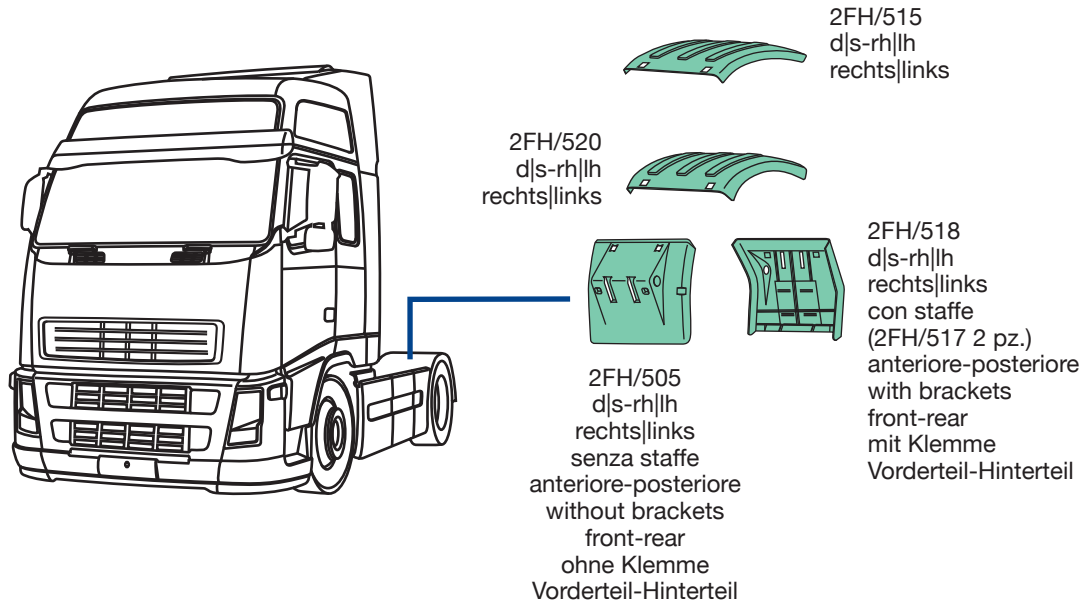

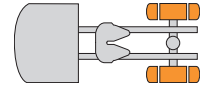

2FH/515
 O.E.M. 20936759
 d|s-rh|lh-rechts|links
 nero, semipiatta, senza cinghietti
 black, semi-flat, without stretchers
 schwarz, halbflach, ohne Spanngummi

2FH/518
 O.E.M. 20392599
 d|s-rh|lh-rechts|links
 nero, senza anti-spray, con staffe
 black, without anti-spray, with brackets
 schwarz, ohne Spritzschutz, mit Klemme

2FH/520
 O.E.M. 20936769
 d|s-rh|lh-rechts|links
 nero, circolare, senza cinghietti
 black, circular, without stretchers
 schwarz, kreisförmig, ohne Spanngummi



2FH/505
 O.E.M. 20392544
 d|s-rh|lh-rechts|links
 nero, senza staffe
 black, without brackets
 schwarz, ohne Klemme

2FH/505

2FH/518

applicabile a | suitable to | verwendbar für:

FH12-FH16 SECONDA SERIE | SECOND SERIES | ZWEITE SERIE

(*) Applicabile con il cinghietto 2FH/510
Applied with stretcher 2FH/510
bestückt mit 2FH/510

(°) Applicabile con il cinghietto PRM/515
Applied with stretcher PRM/515
bestückt mit PRM/515

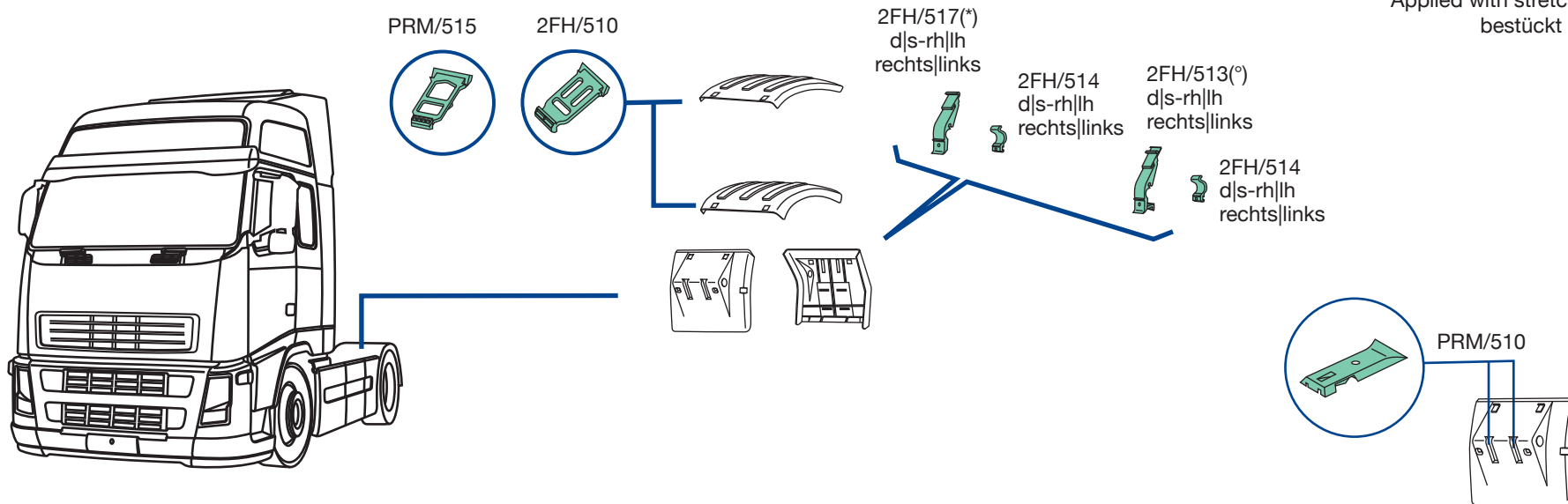

PRM/510
O.E.M. 20721840



PRM/515
O.E.M. 20498623



2FH/510
O.E.M. 1079981



2FH/513
O.E.M. 20583434

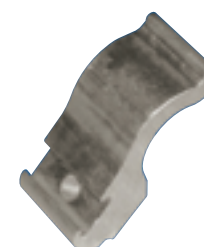

2FH/514
O.E.M. 20583440



2FH/517
O.E.M. 3987252

(*) adattabile a 2FH/505
suitable to 2FH/505
passend für 2FH/505

applicabile a | suitable to | verwendbar für:

FH12-FH16 SECONDA SERIE | SECOND SERIES | ZWEITE SERIE

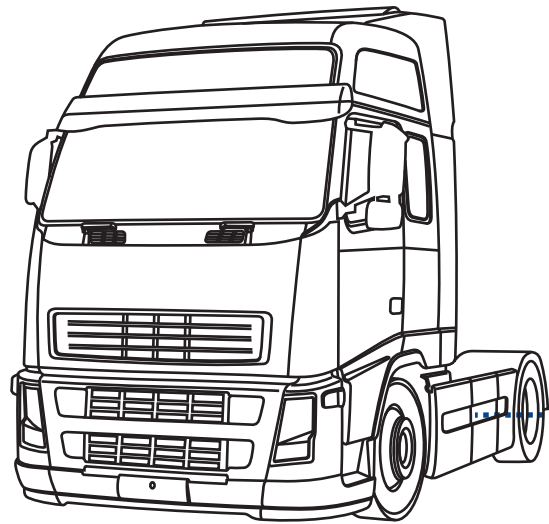

0FH/526
d|s-rh|lh
rechts|links

0FH/527
d|s-rh|lh
rechts|links

0FH/522(*)
d|s-rh|lh
rechts|links

0FH/522(*)
d|s-rh|lh-rechts|links

0FH/522 (*)

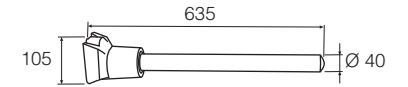

0FH/522
O.E.M. 20466894

0FH/526
O.E.M. 20382890

0FH/527
O.E.M. 20383038

applicabile a | suitable to | verwendbar für:

FH12-FH16 SECONDA SERIE | SECOND SERIES | ZWEITE SERIE

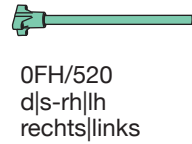

OFH/520
d|s-rh|lh
rechts|links

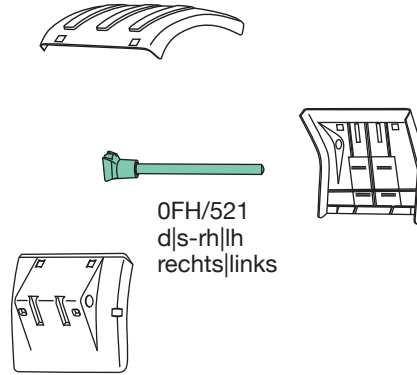

OFH/521
d|s-rh|lh
rechts|links

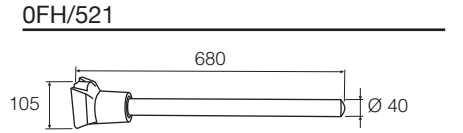
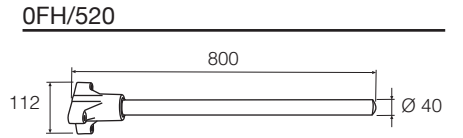

OFH/520
O.E.M. 8154385



OFH/521
O.E.M. 20466895

(*) adattabile a 2FH/505-2FH/518
suitable to 2FH/505-2FH/518
passend für 2FH/505-2FH/518

(°) adattabile a 2FH/505-2FH/518
suitable to 2FH/505-2FH/518
passend für 2FH/505-2FH/518

FH12-FH16 SECONDA SERIE | SECOND SERIES | ZWEITE SERIE

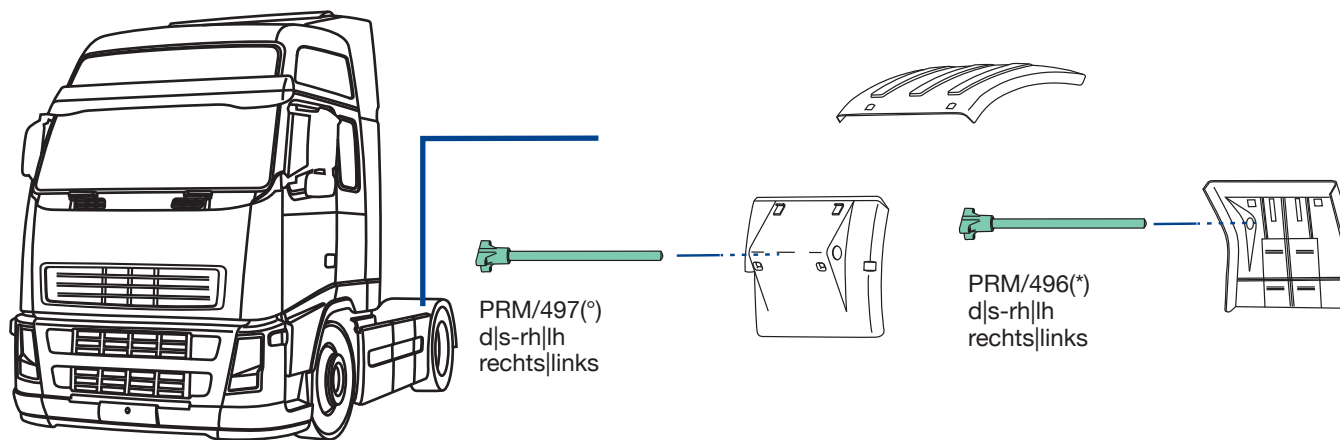
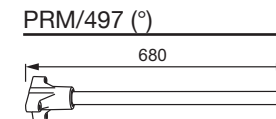
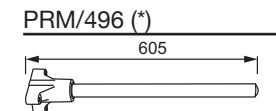

PRM/496
O.E.M. 20843281



PRM/497
O.E.M. 1079959

applicabile a | suitable to | verwendbar für:

FH12-FH16 SECONDA SERIE | SECOND SERIES | ZWEITE SERIE

2FH/522

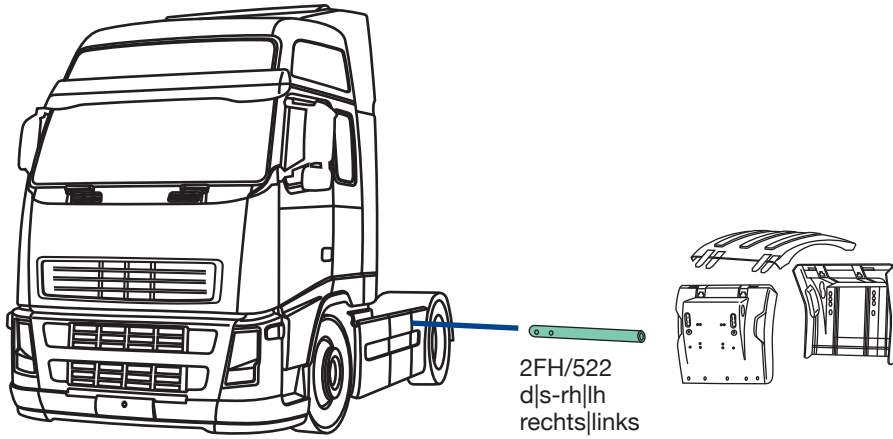
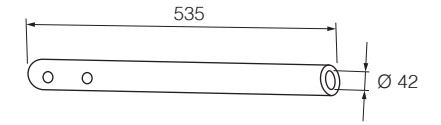

2FH/522
d|s-rh|lh
rechts|links

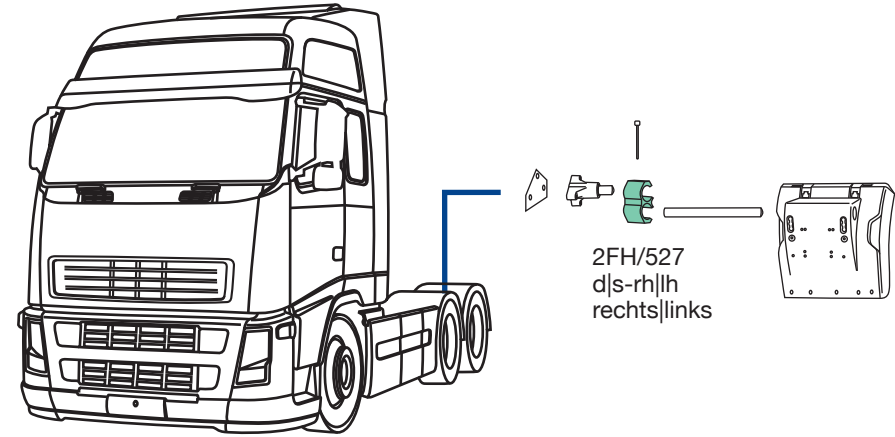

2FH/527
d|s-rh|lh
rechts|links



2FH/522
O.E.M. 20375540



2FH/527
O.E.M. 20375489

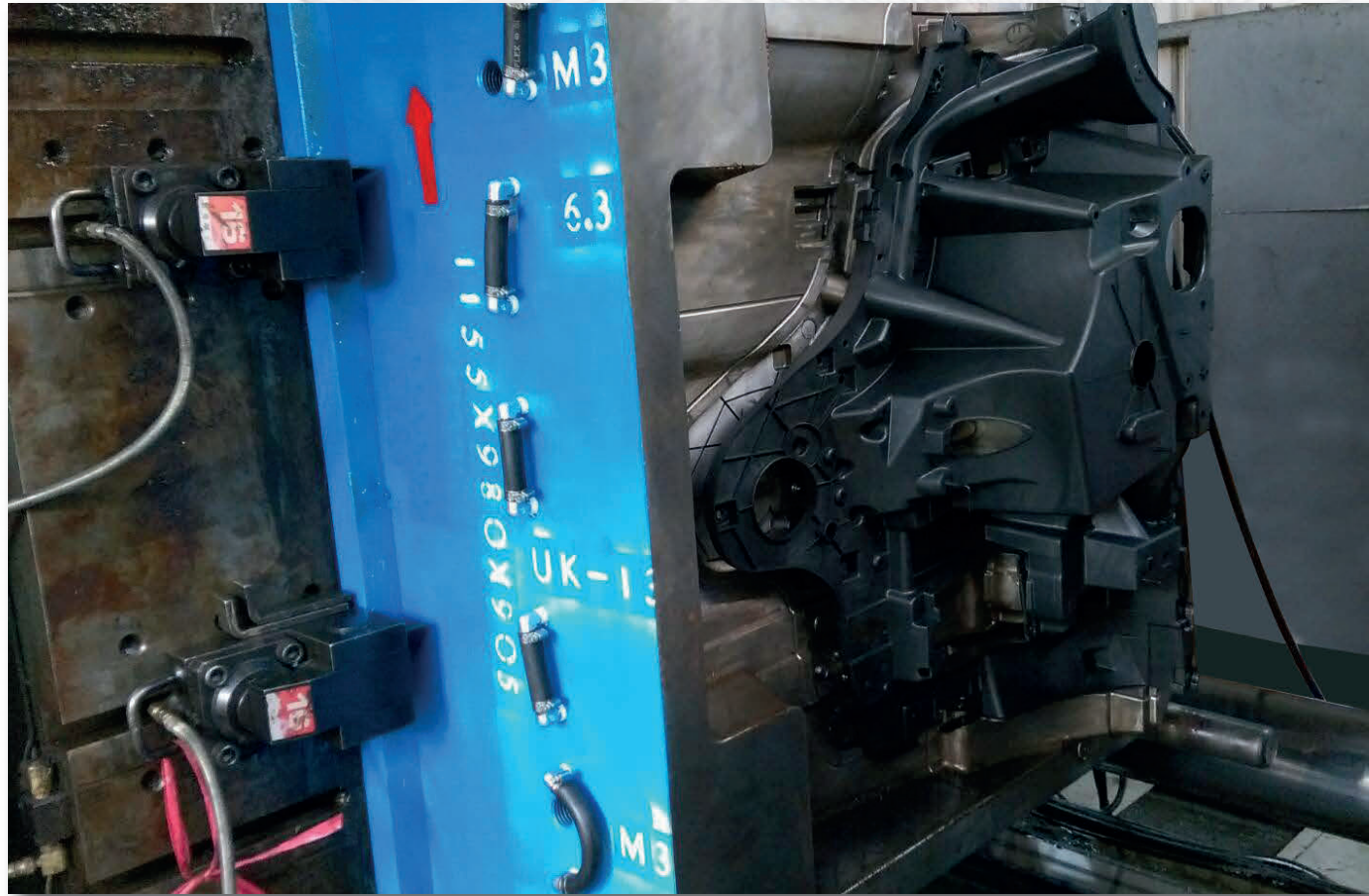

applicabile a | suitable to | verwendbar für:

FH12-FH16 | SECONDA SERIE | SECOND SERIES | ZWEITE SERIE

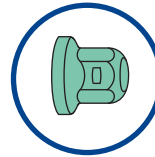
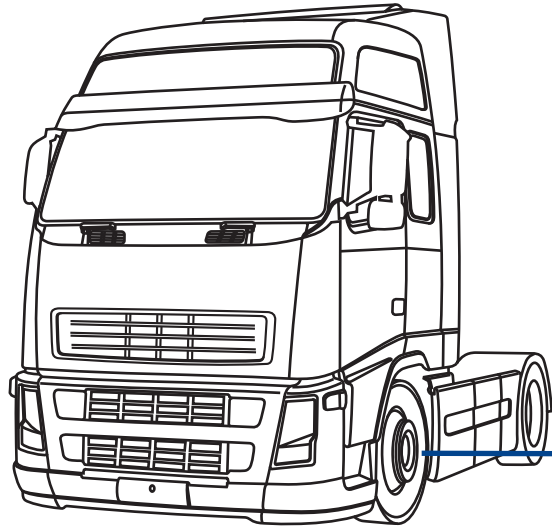

930/033



930/001
d-rh-rechts
930/002
s-lh-links



930/200
d|s-rh|lh
rechts|links

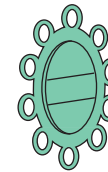

930/100
d-rh-rechts
930/101
s-lh-links



PRM/700
d|s-rh|lh-rechts|links
PRM/710
d|s-rh|lh-rechts|links



930/033
O.E.M. -



930/001
O.E.M. -
930/002
O.E.M. -



930/100
O.E.M. -
930/101
O.E.M. -



930/200
O.E.M. -



PRM/700
O.E.M. 22709903



PRM/710
O.E.M. -

FH12-FH16 SECONDA SERIE | SECOND SERIES | ZWEITE SERIE

930/033-Tappo copri Bullone-Bolt cover-Radmutterkappen

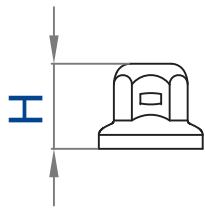

H	45 mm
Per bulloni \varnothing - bolt \varnothing	33 mm
Schlüsselweite \varnothing	
Colore	cromato-chrome-verchromt
Colours-Farbe	
Materiale-Material	acciaio inox-stainless steel Edelstahl
Kg	0,025

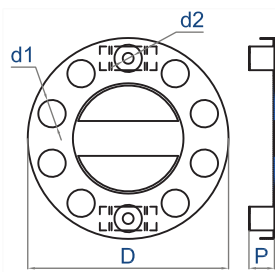

930/001 d-rh-rechts | 930/002 s-lh-links

D \varnothing 425 mm	P 50 mm
d1 nr. 10	d1 \varnothing 58 mm
d2 nr. 2	d2 \varnothing 23 mm
Ventilata	si-yes-Ja
Ventilated-Belüftet	
Colore	cromato e nero-chrome and black verchromt und schwarz
Colours-Farbe	
Materiale-Material	acciaio inox e plastica stainless steel and plastic Edelstahl und Kunststoff
Kg	1,230

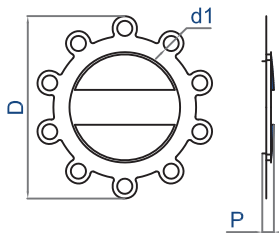

930/100 d-rh-rechts | 930/101 s-lh-links

D \varnothing 387 mm	P 30 mm
d1 nr. 10	d1 \varnothing 32 mm
Ventilata	si-yes-Ja
Ventilated-Belüftet	
Colore	cromato e nero-chrome and black verchromt und schwarz
Colours-Farbe	
Materiale-Material	acciaio inox e plastica stainless steel and plastic Edelstahl und Kunststoff
Kg	0,655

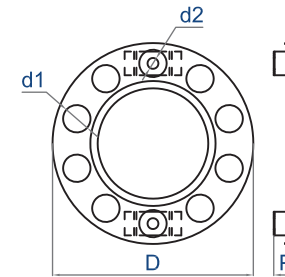

930/200 d|s-rh|lh-rechts+links

D \varnothing 425 mm	P 40 mm
d1 nr. 10	d1 \varnothing 58 mm
d2 nr. 2	d2 \varnothing 23 mm
Ventilata	no-nein
Ventilated-Belüftet	
Colore	cromato-chrome-verchromt
Colours-Farbe	
Materiale-Material	acciaio inox-stainless steel Edelstahl
Kg	1,155

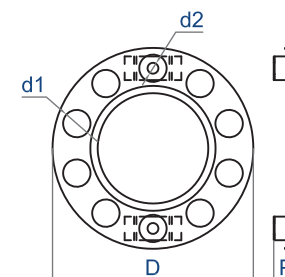

PRM/700 d|s-rh|lh-rechts+links

D \varnothing 425 mm	P 40 mm
d1 nr. 10	d1 \varnothing 58 mm
d2 nr. 2	d2 \varnothing 24 mm
Ventilata	no-nein
Ventilated-Belüftet	
Colore	silver-silver-Silber
Colours-Farbe	
Materiale-Material	acciaio inox-stainless steel Edelstahl
Kg	1,700

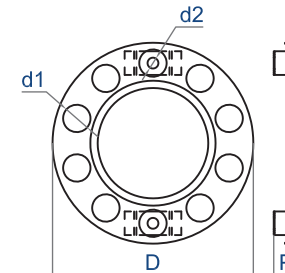

PRM/710 d|s-rh|lh-rechts+links

D \varnothing 425 mm	P 40 mm
d1 nr. 10	d1 \varnothing 58 mm
d2 nr. 2	d2 \varnothing 24 mm
Ventilata	no-nein
Ventilated-Belüftet	
Colore	cromato-chrome-verchromt
Colours-Farbe	
Materiale-Material	acciaio inox-stainless steel Edelstahl
Kg	1,700

applicabile a | suitable to | verwendbar für:

FH12-FH16 SECONDA SERIE | SECOND SERIES | ZWEITE SERIE

2FH/610 d|s-rh|lh-rechts|links

2002→

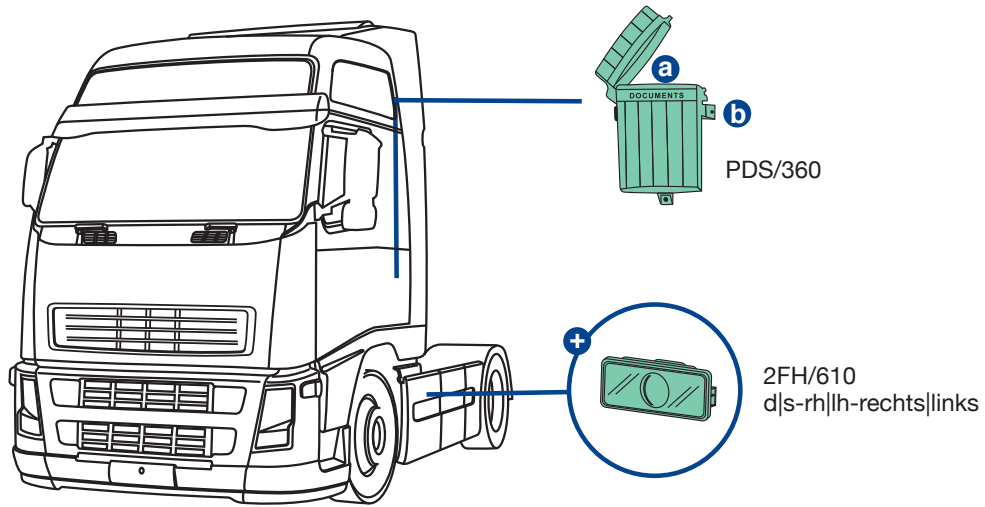
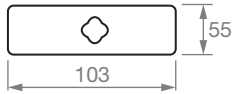

PDS/360

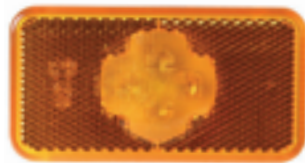
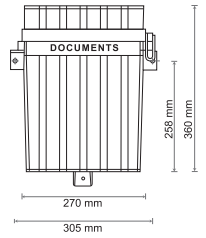

2FH/610
O.E.M. 20789440



PDS/360
O.E.M. -



0FH/670

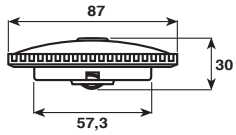

0FH/675

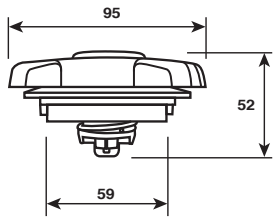

943/670

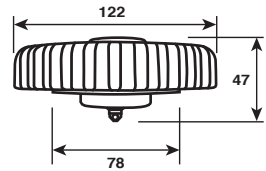

XF0/670

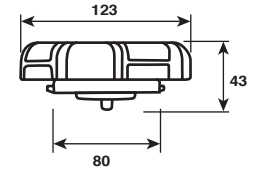

0FH/670



0FH/675

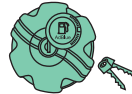

943/670



XF0/670

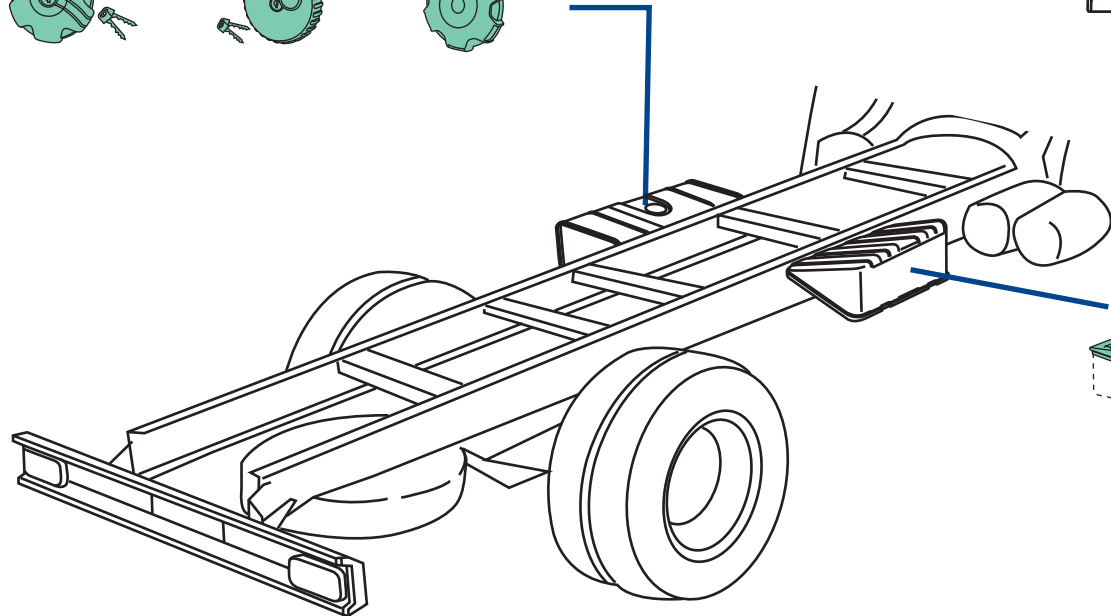

2FH/619

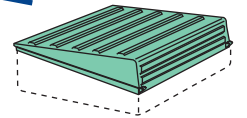

0FH/670
O.E.M. 20896946



0FH/675
O.E.M. 21281403



943/670
O.E.M. 20392752



XF0/670
O.E.M. -

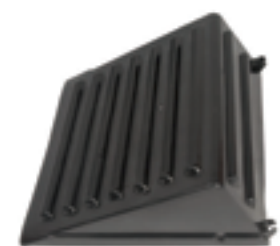

2FH/619
O.E.M. 20507252

gallery





applicabile a | suitable to | verwendbar für

283

OFH

FH12-FH16 (1993→2001)

PRIMA SERIE | FIRST SERIES | ERSTE SERIE

applicabile a | suitable to | verwendbar für:

FH12-FH16 PRIMA SERIE | FIRST SERIES | ERSTE SERIE

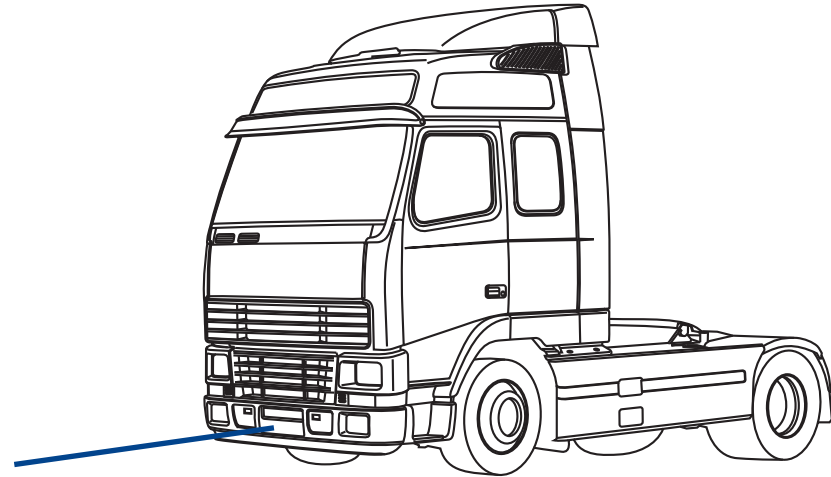
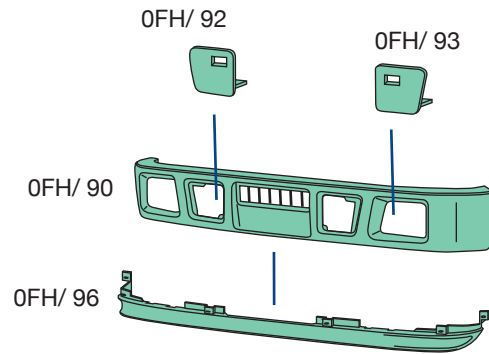

0FH/ 90
O.E.M. 8189329



0FH/ 92
O.E.M. 20372227
0FH/ 93
O.E.M. 20372226



0FH/ 96
O.E.M. 8152722

FH12-FH16 PRIMA SERIE | FIRST SERIES | ERSTE SERIE

OFH/650 d|s-rh|lh-rechts|links

H3

E

OFH/720 d-rh-rechts | OFH/721 s-lh-links 1998→2002

H3

E

OFH/720 d-rh-rechts
OFH/721 s-lh-links



OFH/650

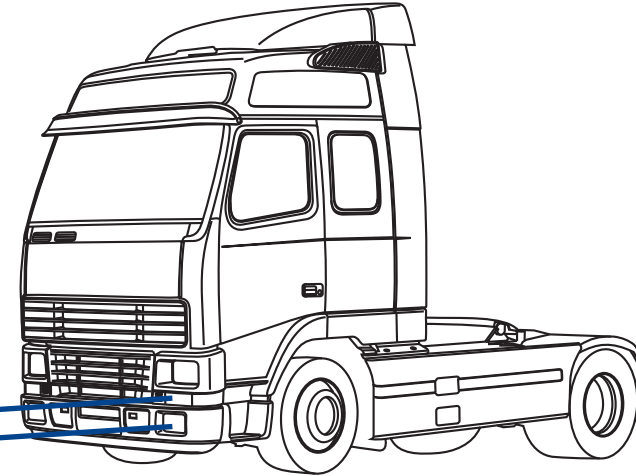

OFH/650
O.E.M. 1062190



OFH/720
O.E.M. 20360274
OFH/721
O.E.M. 20360273

applicabile a | suitable to | verwendbar für:

FH12-FH16 PRIMA SERIE | FIRST SERIES | ERSTE SERIE

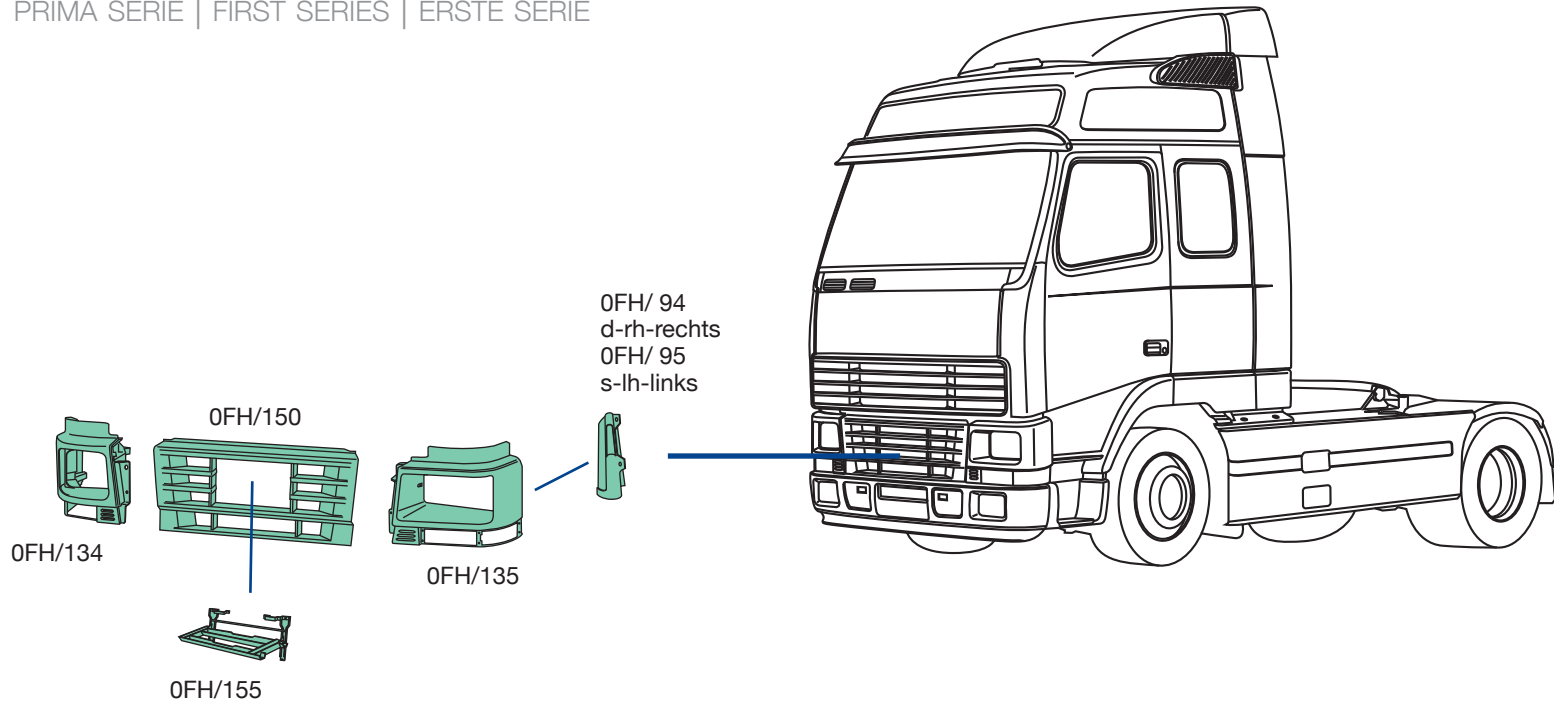

OFH/134
O.E.M. 20398386
OFH/135
O.E.M. 20398385



OFH/94
O.E.M. 8141290
OFH/95
O.E.M. 8141289



OFH/150
O.E.M. 1063509



OFH/155
O.E.M. 3175863



FH12-FH16 PRIMA SERIE | FIRST SERIES | ERSTE SERIE

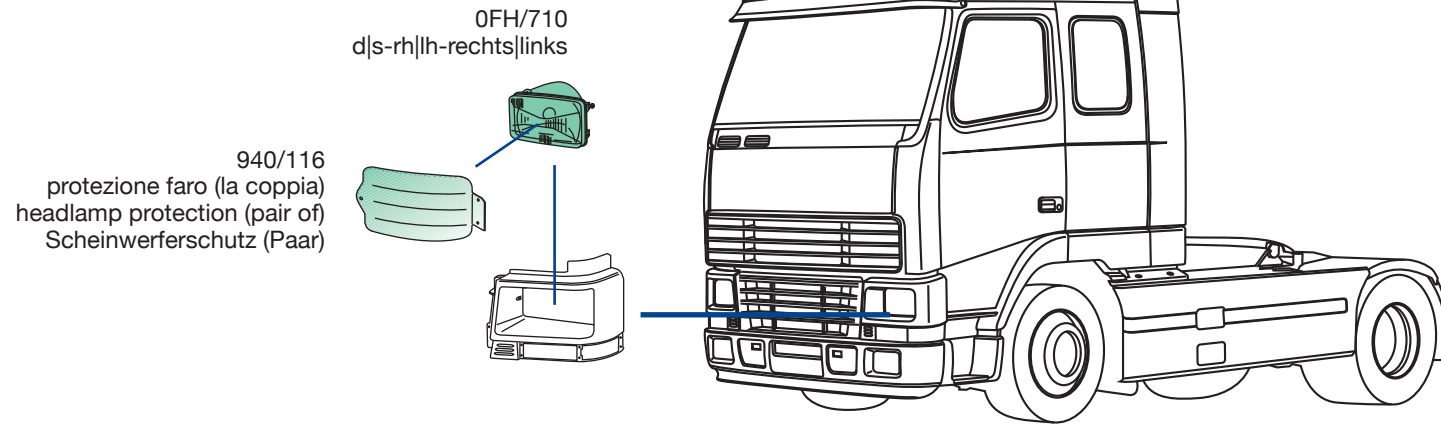

0FH/710
O.E.M. 3981593



940/116
O.E.M. -

applicabile a | suitable to | verwendbar für:

FH12-FH16 PRIMA SERIE | FIRST SERIES | ERSTE SERIE

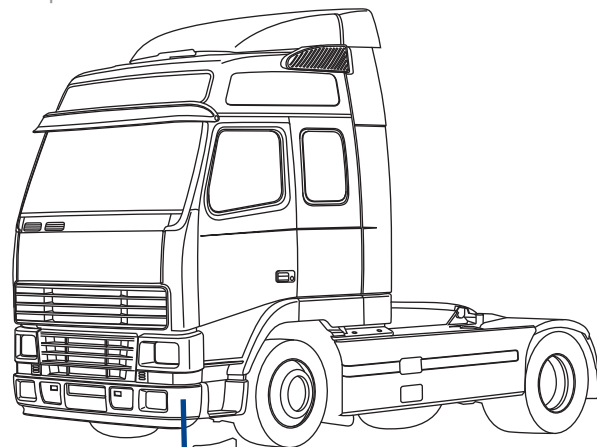

0FH/610
d|s-rh||h-rechts|links



0FH/604
d|s-rh||h-rechts|links

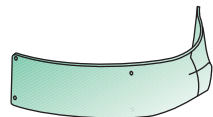

940/110
protezione fanale (la coppia)
light protection (pair of)
Stand-Blinkleuchenschutz (Paar)

0FH/604 d|s-rh||h-rechts|links

1993→2001



0FH/610 d|s-rh||h-rechts|links

1993→2001

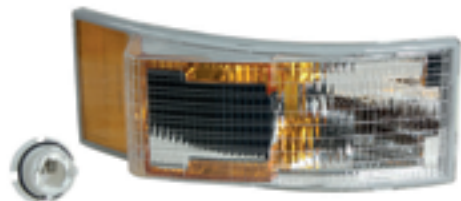

0FH/604
O.E.M. 3981668



0FH/610
O.E.M. 3981666



940/110
O.E.M. -

FH12-FH16 PRIMA SERIE | FIRST SERIES | ERSTE SERIE

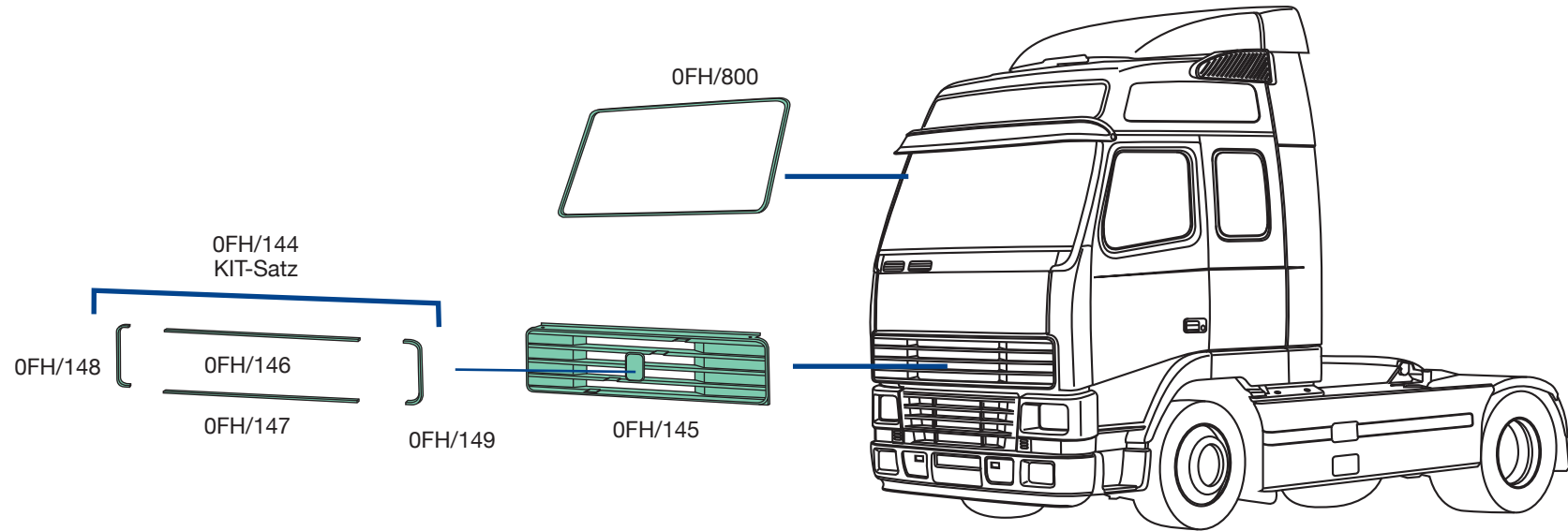

OFH/145
O.E.M. 20360507



OFH/146
O.E.M. 8144524
OFH/147
O.E.M. 8144525



OFH/148
O.E.M. 8144527
OFH/149
O.E.M. 8144526



OFH/800
O.E.M. 1619254

applicabile a | suitable to | verwendbar für:

FH12-FH16 PRIMA SERIE | FIRST SERIES | ERSTE SERIE

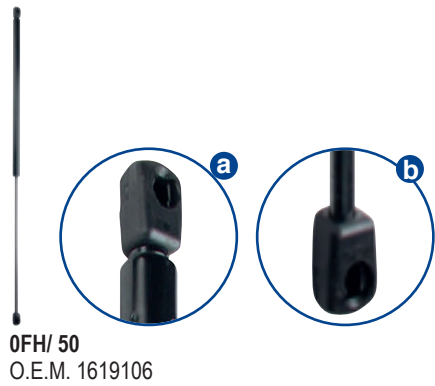
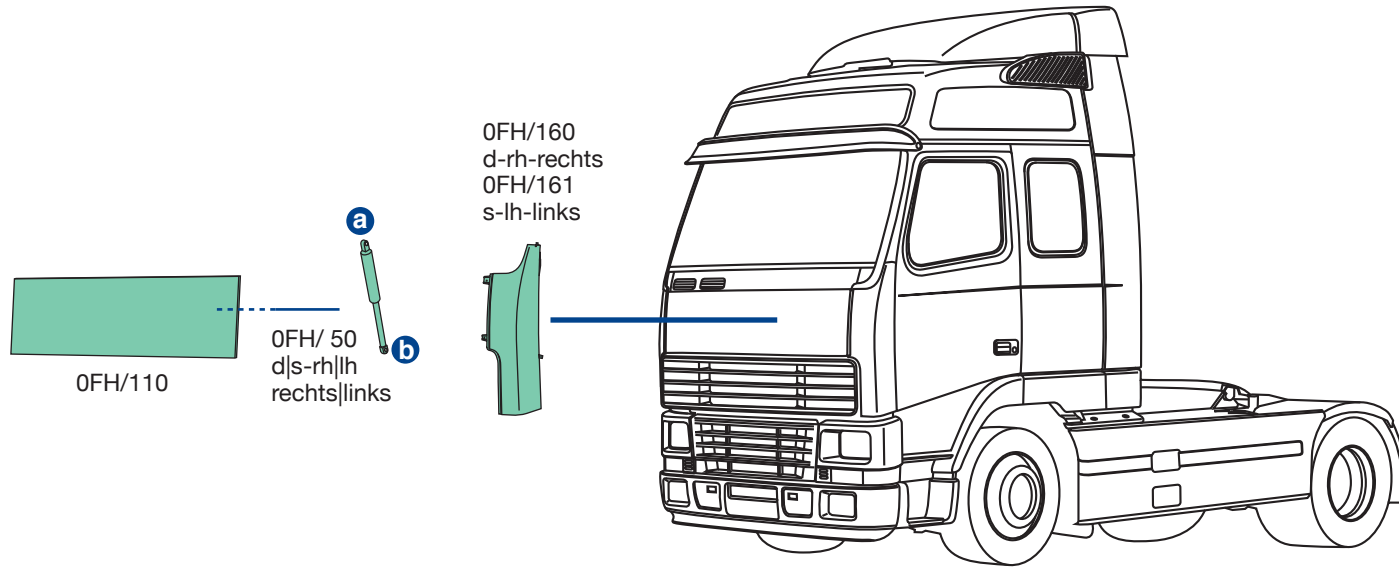

0FH/400 8189318
8140923

materiale | material | material PMMA - Acrylglas

peso | weight | Gewicht 2,630 Kg

applicabilità | suitable to | für
VOLVO 0FH. FH1
VOLVO 0FM. FM1

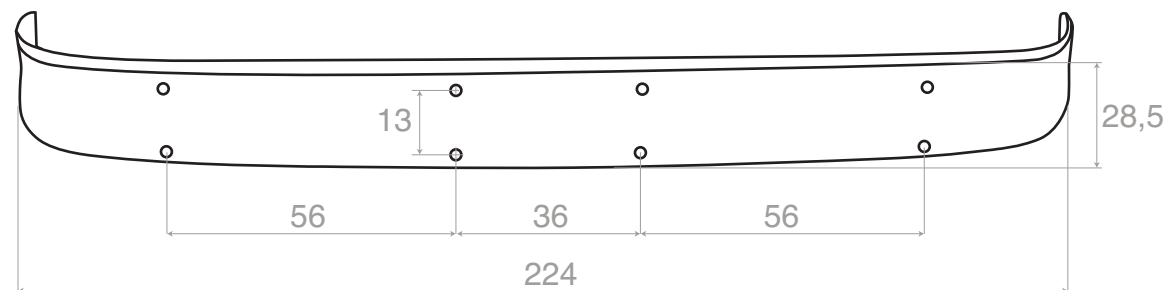
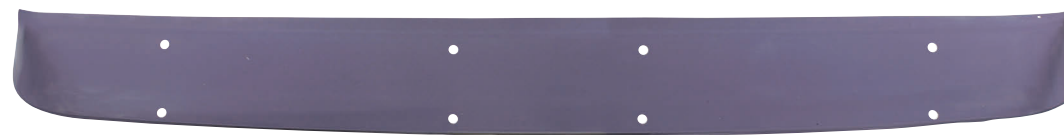

(cm)

extra



applicabile a | suitable to | verwendbar für:

FH12-FH16 PRIMA SERIE | FIRST SERIES | ERSTE SERIE



0FH/508



II

E4 024109

198x433 mm



IV

E4 024110

181x175 mm

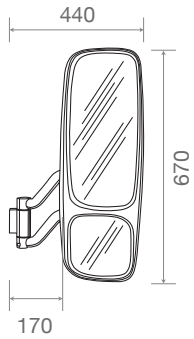

applicabilità:
applicable to:
Verwendbar für

VOLVO 0FH. FH 1993→2002
VOLVO 0FM. FM 1998→2002



COVIND
II
IV

FH12-FH16 PRIMA SERIE | FIRST SERIES | ERSTE SERIE

a 0FH/512

3091751



240x250 mm

b 0FH/506

20854564
(3092854)

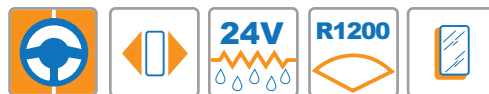

E4 024109

198x433 mm

II

c 0FH/507

21203311

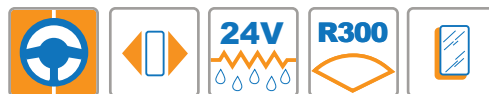

E4 024110

181x175 mm

IV

applicabile a | suitable to | verwendbar für:

FH12-FH16 PRIMA SERIE | FIRST SERIES | ERSTE SERIE



0FH/509



II E4 024109
198x433 mm



IV E4 024110
181x175 mm

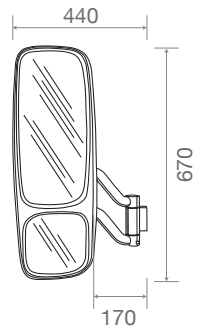

applicabilità:
applicable to:
Verwendbar für

VOLVO 0FH. FH 1993→2002
VOLVO 0FM. FM 1998→2002



COVIND
II
IV

FH12-FH16 PRIMA SERIE | FIRST SERIES | ERSTE SERIE

a 0FH/513

3091750



240x250 mm

b 0FH/506

20854564
(3092854)

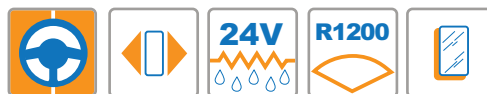

E4 024109

198x433 mm

II

c 0FH/507

21203311

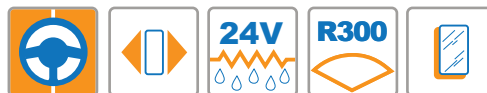

E4 024110

181x175 mm

IV

applicabile a | suitable to | verwendbar für:

FH12-FH16 PRIMA SERIE | FIRST SERIES | ERSTE SERIE

2FH/506

20854644
(1096643)

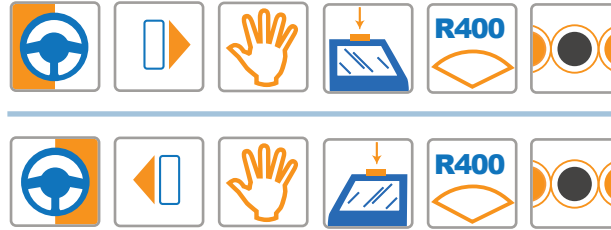

V E9 026322
275x165 mm

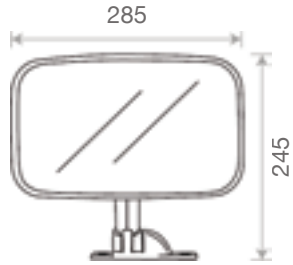

applicabilità:
applicable to:
Verwendbar für

VOLVO 0FH. FH I
VOLVO 2FH. FH II
VOLVO 0FM. FM I
VOLVO 2FM. FM II





applicabile a | suitable to | verwendbar für:

FH12-FH16 PRIMA SERIE | FIRST SERIES | ERSTE SERIE

0FH/190

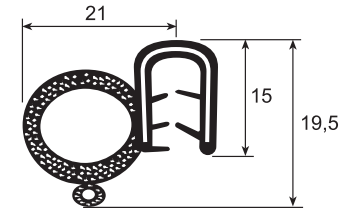

2FH/ 6 d-rh-rechts
2FH/ 7 s-lh-links

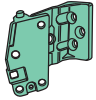

2FH/ 9
d|s-rh|lh
rechts|links

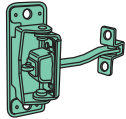

2FH/ 10
d|s-rh|lh
rechts|links

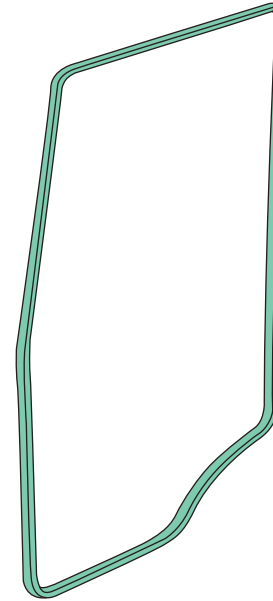
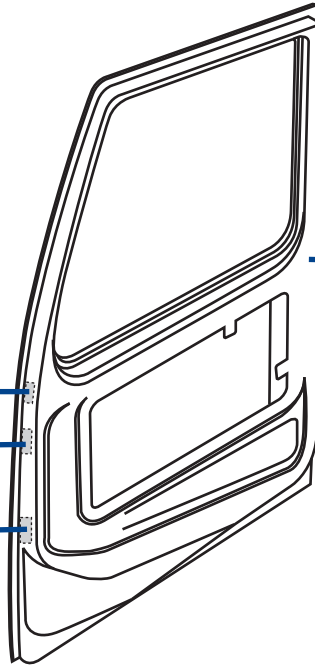
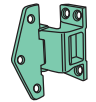

0FH/190



2FH/ 6
O.E.M. 20398136
2FH/ 7
O.E.M. 20398135

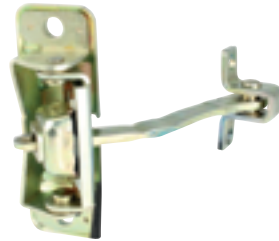

2FH/ 9
O.E.M. 1062636



2FH/ 10
O.E.M. 20372039



0FH/190
O.E.M. 3175029

FH12-FH16 PRIMA SERIE | FIRST SERIES | ERSTE SERIE

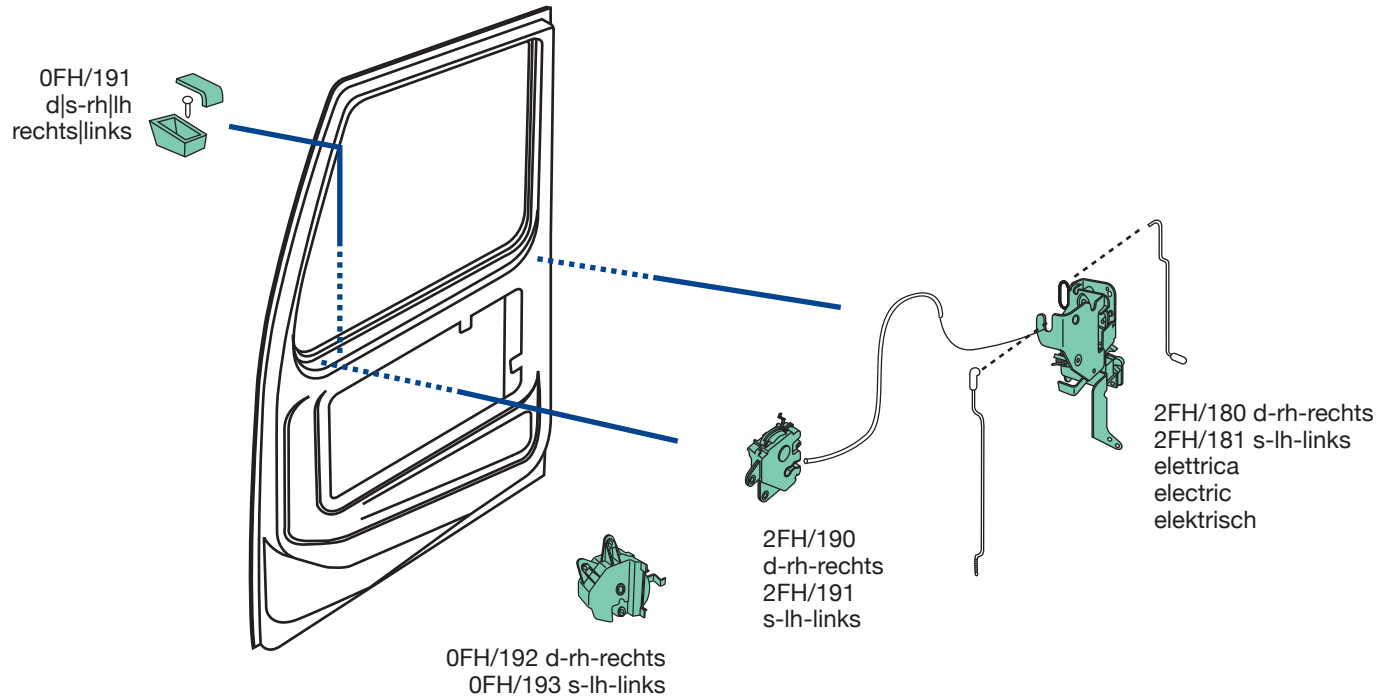

0FH/191
O.E.M. 20379593



0FH/192
O.E.M. 1063328
0FH/193
O.E.M. 1063327



2FH/180
O.E.M. 21505894
2FH/181
O.E.M. 21505893



2FH/190
O.E.M. 20570722
2FH/191
O.E.M. 20570721

applicabile a | suitable to | verwendbar für:

FH12-FH16 PRIMA SERIE | FIRST SERIES | ERSTE SERIE

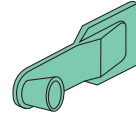
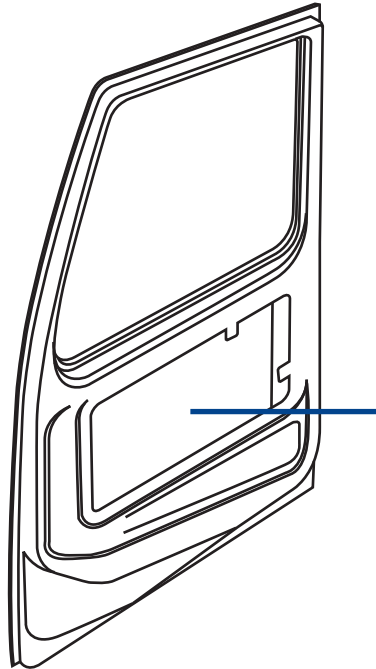

OFH/166
d|s-rh|lh-rechts|links

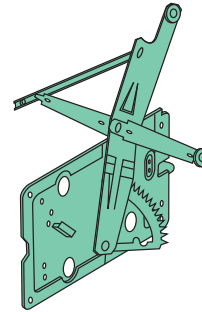

OFM/174 d-rh-rechts
OFM/175 s-lh-links
elettrico, senza motorino
electric, without motor
elektrisch, ohne Motor



OFH/166
O.E.M. 3953182



OFM/174
O.E.M. -
OFM/175
O.E.M. -

FH12-FH16 PRIMA SERIE | FIRST SERIES | ERSTE SERIE

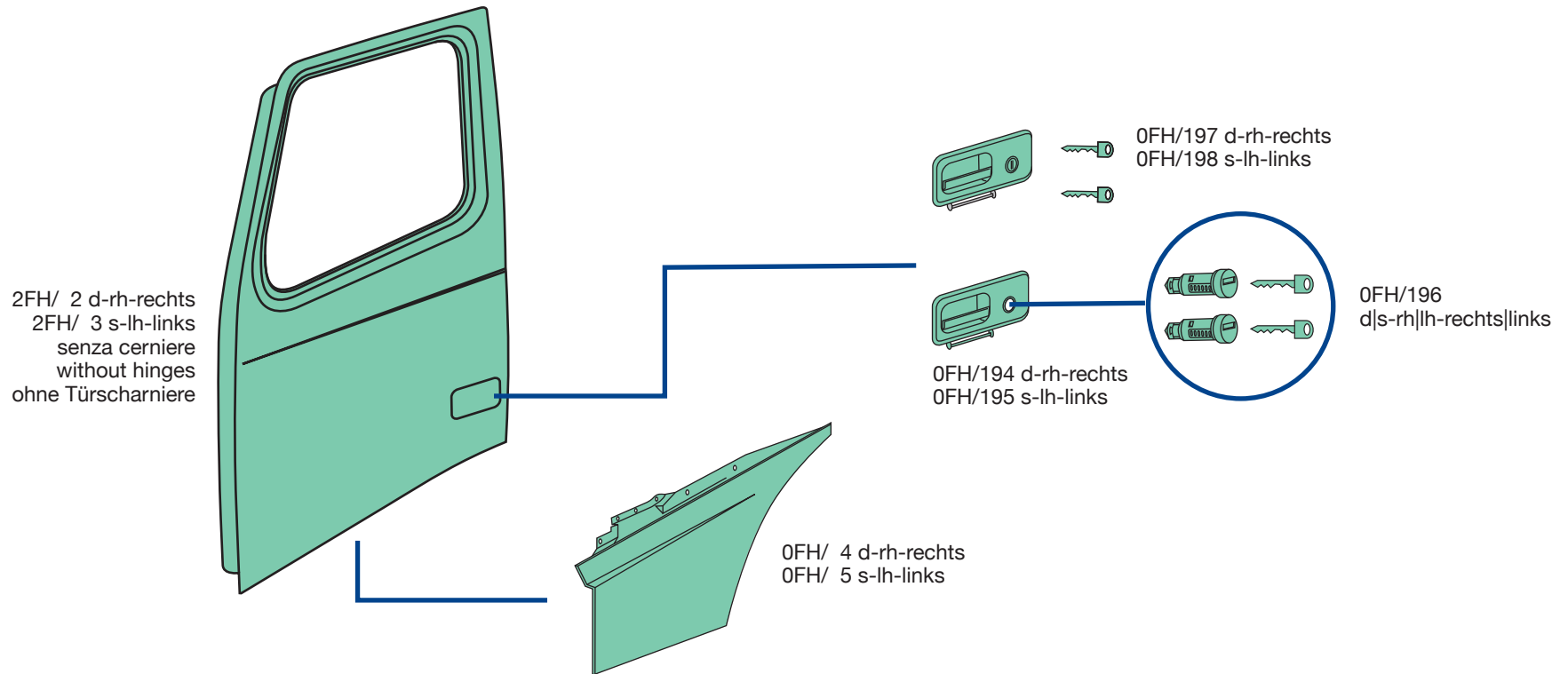

0FH/ 4
O.E.M. 20398908
0FH/ 5
O.E.M. 20398907

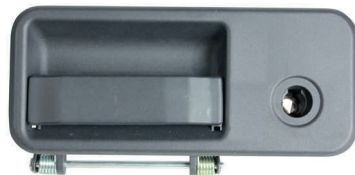

0FH/194
O.E.M. 20398467
0FH/195
O.E.M. 20398466



0FH/196
O.E.M. 3090484



0FH/197
O.E.M. -
0FH/198
O.E.M. -



2FH/ 2
O.E.M. 20360543
2FH/ 3
O.E.M. 20360542

applicabile a | suitable to | verwendbar für:

FH12-FH16 PRIMA SERIE | FIRST SERIES | ERSTE SERIE

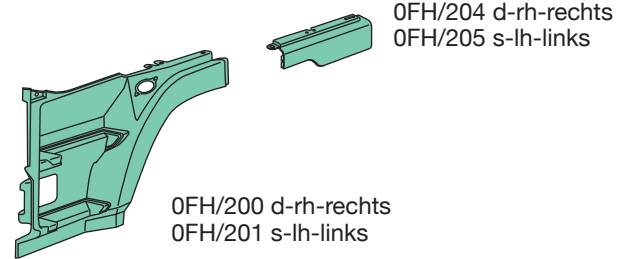
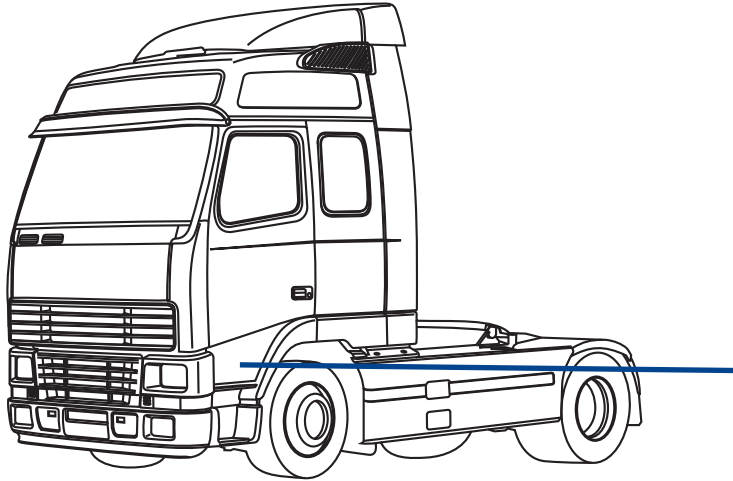

0FH/200
O.E.M. 8144108



0FH/201
O.E.M. 8144107



0FH/204
O.E.M. 8141237
0FH/205
O.E.M. 8141236

FH12-FH16 PRIMA SERIE | FIRST SERIES | ERSTE SERIE

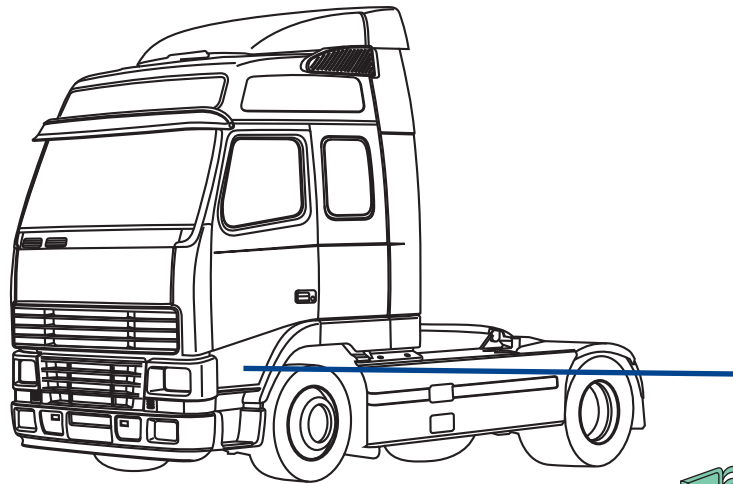

0FH/199

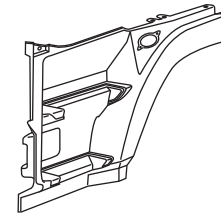

0FH/240 d-rh-rechts
0FH/241 s-lh-links
guida sinistra
lh drive
Linksenker



0FH/199
O.E.M. 20529765



0FH/240
O.E.M. 8141004



0FH/241
O.E.M. 8141003

applicabile a | suitable to | verwendbar für:

FH12-FH16 PRIMA SERIE | FIRST SERIES | ERSTE SERIE

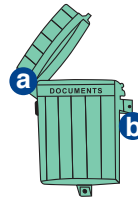
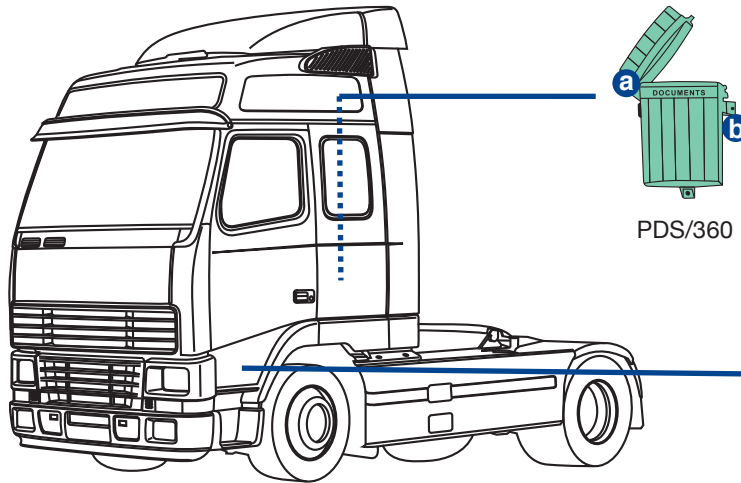

PDS/360

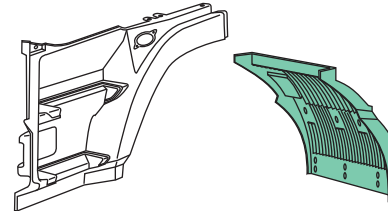

OFH/320 d-rh-rechts
OFH/321 s-lh-links

OFH/242 d-rh-rechts
OFH/243 s-lh-links
guida destra
rh drive
Rechtslenker



PDS/360

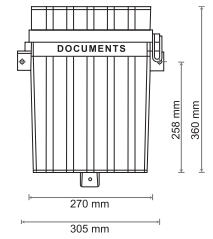

OFH/242
O.E.M. 8141313



OFH/243
O.E.M. 8141312



OFH/320
O.E.M. 1623459
OFH/321
O.E.M. 8156540



PDS/360
O.E.M. -

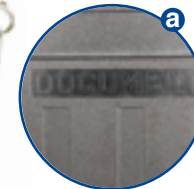

FH12-FH16 PRIMA SERIE | FIRST SERIES | ERSTE SERIE

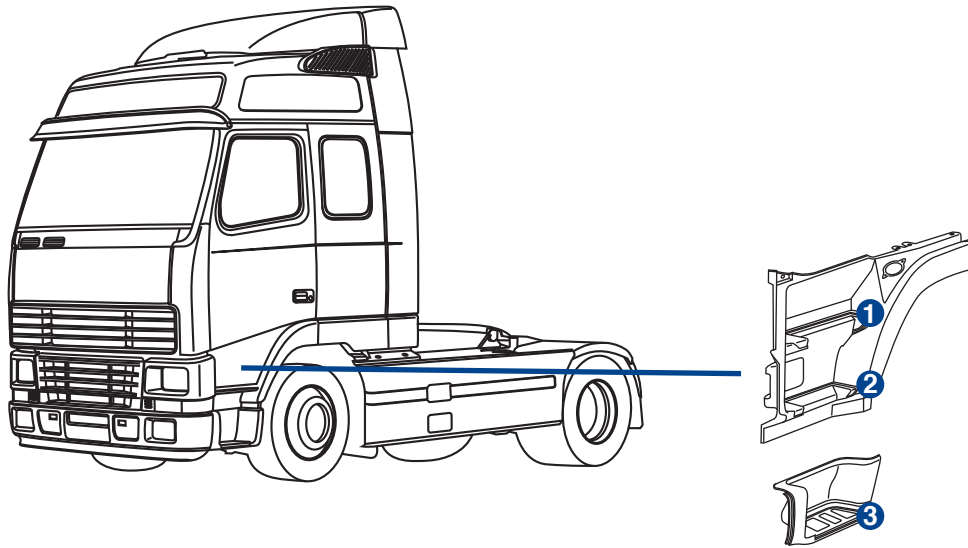

- 1 0FH/210
d|s-rh||lh-rechts|links
- 2 0FH/212
d|s-rh||lh-rechts|links
- 3 0FH/215
d|s-rh||lh-rechts|links

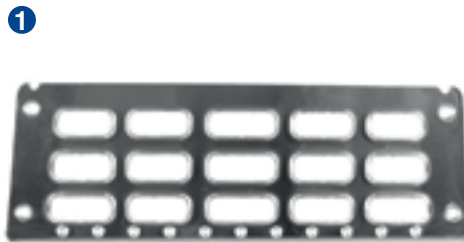

0FH/210
O.E.M. 20379439



0FH/212
O.E.M. 20379438



0FH/215
O.E.M. 20379437

applicabile a | suitable to | verwendbar für:

FH12-FH16 PRIMA SERIE | FIRST SERIES | ERSTE SERIE

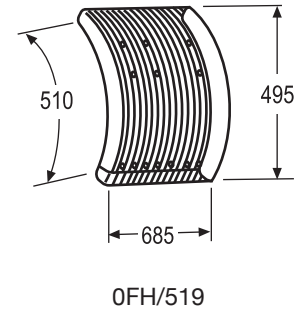
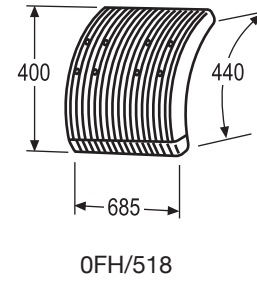
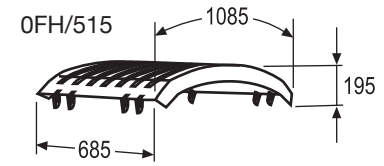
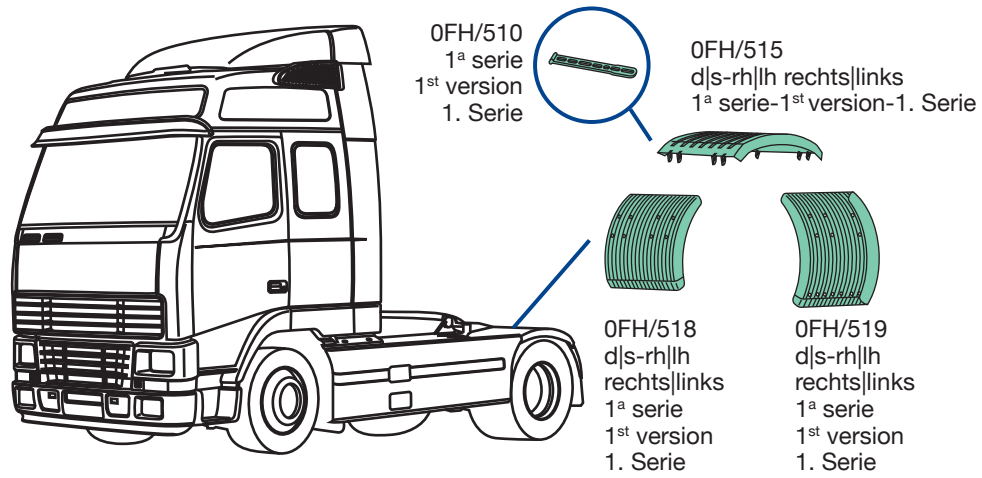

0FH/510
O.E.M. 8156556

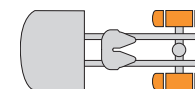

0FH/515
 O.E.M. 8190106
 d|s-rh||h-rechts|links
 nero, semipiatta con cinghietti
 black, semi-flat with stretchers
 schwarz, halbflach mit Spanngummi



0FH/519
 O.E.M. 8156554
 d|s-rh||h-rechts|links
 nero, senza anti-spray
 black, without anti-spray
 schwarz, ohne Spritzschutz



0FH/518
 O.E.M. 8156551
 d|s-rh||h-rechts|links
 nero-black-schwarz

FH12-FH16 PRIMA SERIE | FIRST SERIES | ERSTE SERIE

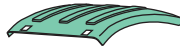

2FH/515
d|s-rh|lh
rechts|links



2FH/520
d|s-rh|lh
rechts|links

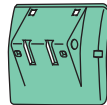

2FH/505
d|s-rh|lh
rechts|links
senza staffe
anteriore|posteriore
without brackets
front|rear
ohne Klemme
Vorderteil|Hinterteil



2FH/518
d|s-rh|lh
rechts|links
con staffe
(2FH/517 2 pz.)
anteriore|posteriore
with brackets
front|rear
mit Klemme
Vorderteil|Hinterteil

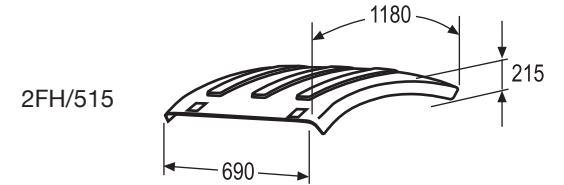

2FH/515

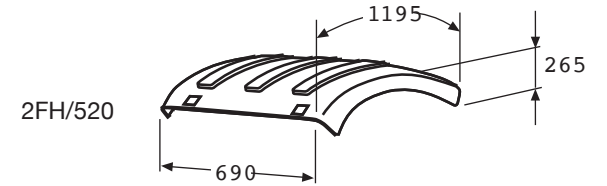

2FH/520

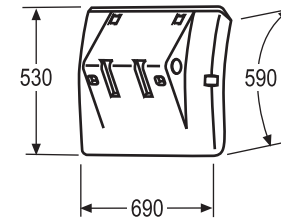

2FH/505

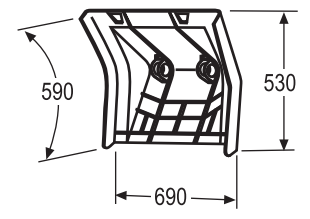

2FH/518

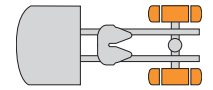

2FH/515
 O.E.M. 20936759
 d|s-rh|lh-rechts|links
 nero, semipiatta, senza cinghietti
 black, semi-flat, without stretchers
 schwarz, halbflach, ohne Spanngummi

2FH/518
 O.E.M. 20392599
 d|s-rh|lh-rechts|links
 nero, senza anti-spray, con staffe
 black, without anti-spray, with brackets
 schwarz, ohne Spritzschutz, mit Klemme

2FH/520
 O.E.M. 20936769
 d|s-rh|lh-rechts|links
 nero, circolare, senza cinghietti
 black, circular, without stretchers
 schwarz, kreisförmig, ohne Spanngummi



2FH/505
 O.E.M. 20392544
 d|s-rh|lh-rechts|links
 nero, senza staffe
 black, without brackets
 schwarz, ohne Klemme

2FH/505

2FH/518

applicabile a | suitable to | verwendbar für:

FH12-FH16 PRIMA SERIE | FIRST SERIES | ERSTE SERIE

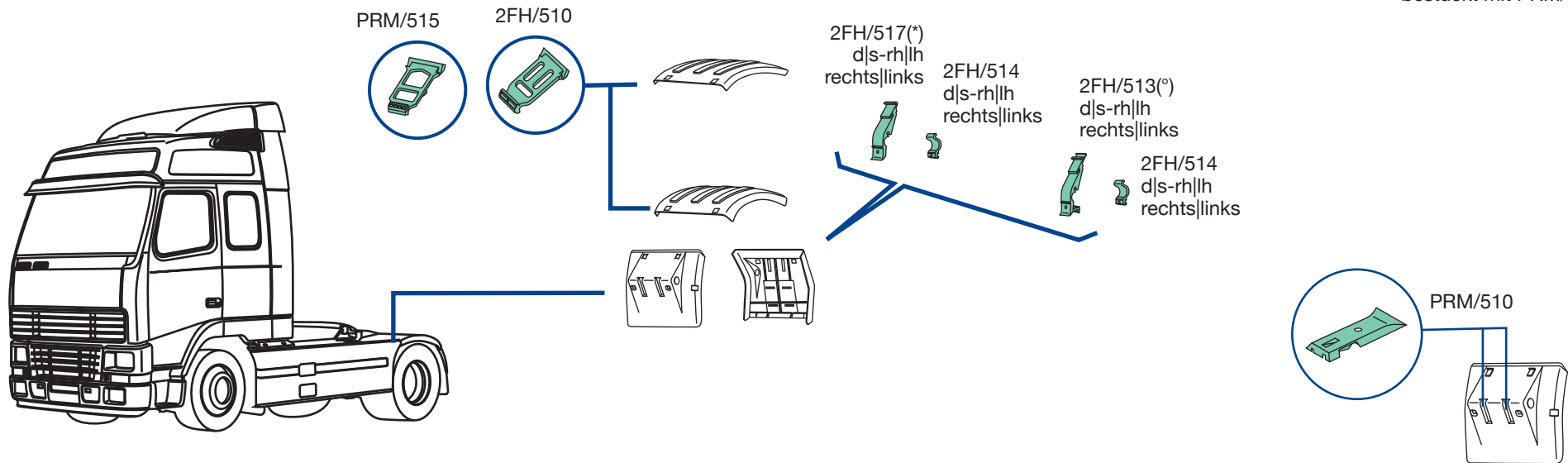

(*) Applicabile con il cinghietto 2FH/510
Applied with stretcher 2FH/510
bestückt mit 2FH/510

(°) Applicabile con il cinghietto PRM/515
Applied with stretcher PRM/515
bestückt mit PRM/515

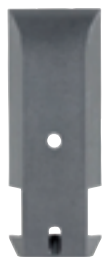

PRM/510
O.E.M. 20721840



PRM/515
O.E.M. 20498623



2FH/510
O.E.M. 1079981



2FH/513
O.E.M. 20583434



2FH/514
O.E.M. 20583440



2FH/517
O.E.M. 3987252

FH12-FH16 PRIMA SERIE | FIRST SERIES | ERSTE SERIE



OFH/520
d|s-rh|lh
rechts|links



OFH/521
d|s-rh|lh
rechts|links

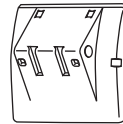
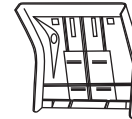

OFH/520

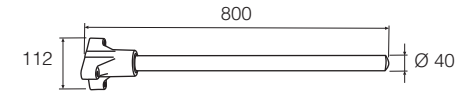

OFH/521

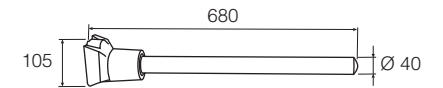

OFH/520
O.E.M. 8154385



OFH/521
O.E.M. 20466895

applicabile a | suitable to | verwendbar für:

FH12-FH16 PRIMA SERIE | FIRST SERIES | ERSTE SERIE

0FH/522 (*)

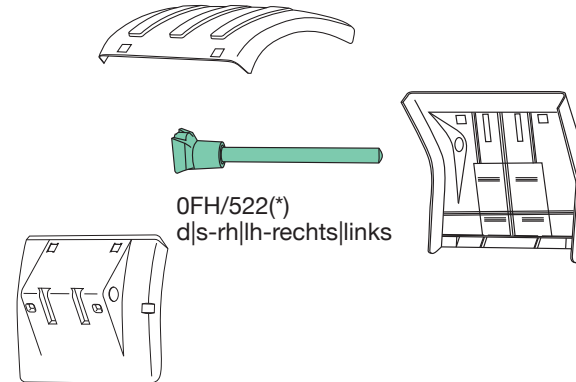
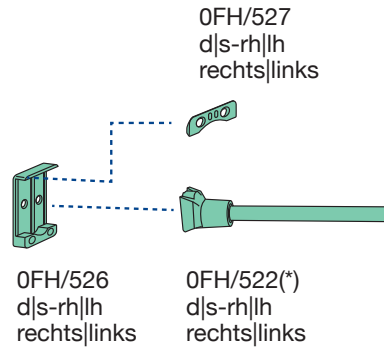
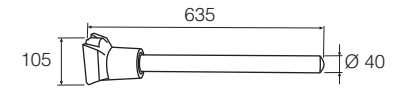

0FH/522
O.E.M. 20466894



0FH/526
O.E.M. 20382890



0FH/527
O.E.M. 20383038

FH12-FH16 PRIMA SERIE | FIRST SERIES | ERSTE SERIE

(*) adattabile a 2FH/505-2FH/518
suitable to 2FH/505-2FH/518
passend für 2FH/505-2FH/518

(°) adattabile a 2FH/505-2FH/518
suitable to 2FH/505-2FH/518
passend für 2FH/505-2FH/518

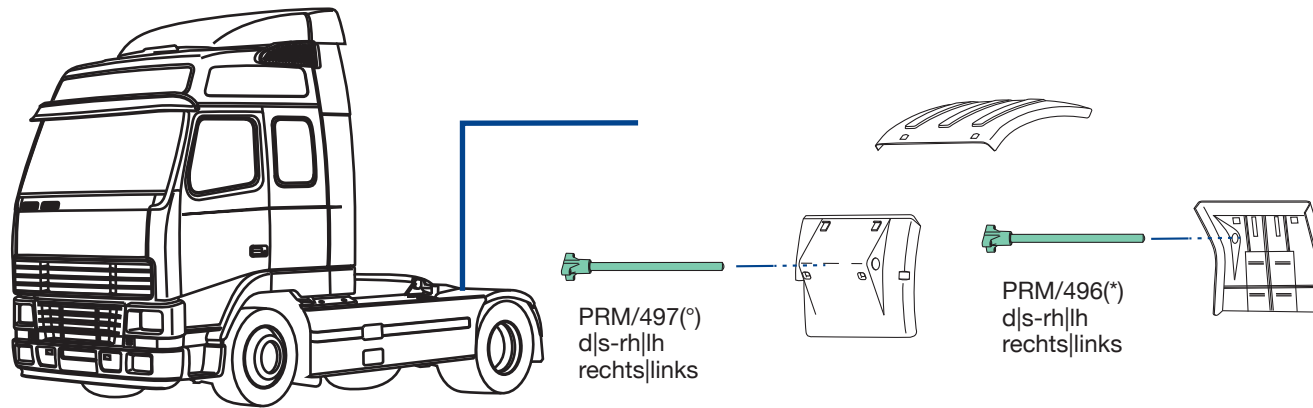
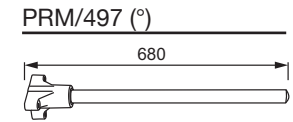
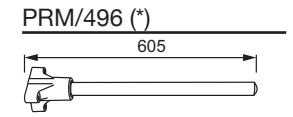

PRM/496
O.E.M. 20843281



PRM/497
O.E.M. 1079959

applicabile a | suitable to | verwendbar für:

FH12-FH16 PRIMA SERIE | FIRST SERIES | ERSTE SERIE

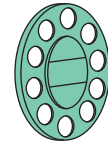
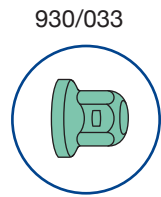

930/001
d-rh-rechts
930/002
s-lh-links



930/200
d|s-rh|lh
rechts|links

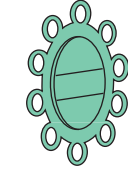

930/100
d-rh-rechts
930/101
s-lh-links

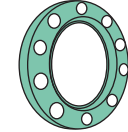

PRM/700
d|s-rh|lh-rechts|links
PRM/710
d|s-rh|lh-rechts|links



930/033
O.E.M. -



930/001
O.E.M. -
930/002
O.E.M. -



930/100
O.E.M. -
930/101
O.E.M. -



930/200
O.E.M. -



PRM/700
O.E.M. 22709903



PRM/710
O.E.M. -

FH12-FH16 PRIMA SERIE | FIRST SERIES | ERSTE SERIE

930/033-Tappo copri Bullone-Bolt cover-Radmutterkappen

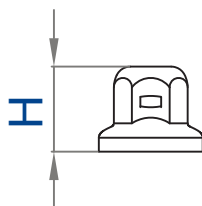

H	45 mm
Per bulloni \varnothing - bolt \varnothing	33 mm
Schlüsselweite \varnothing	
Colore	cromato-chrome-verchromt
Colours-Farbe	
Materiale-Material	acciaio inox-stainless steel Edelstahl
Kg	0,025

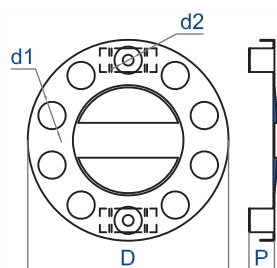

930/001 d-rh-rechts | 930/002 s-lh-links

D \varnothing 425 mm	P 50 mm
d1 nr. 10	d1 \varnothing 58 mm
d2 nr. 2	d2 \varnothing 23 mm
Ventilata	si-yes-Ja
Ventilated-Belüftet	
Colore	cromato e nero-chrome and black
Colours-Farbe	verchromt und schwarz
Materiale-Material	acciaio inox e plastica stainless steel and plastic Edelstahl und Kunststoff
Kg	1,230

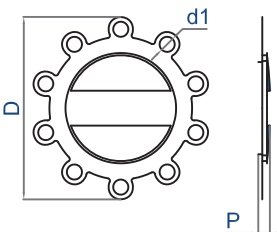

930/100 d-rh-rechts | 930/101 s-lh-links

D \varnothing 387 mm	P 30 mm
d1 nr. 10	d1 \varnothing 32 mm
Ventilata	si-yes-Ja
Ventilated-Belüftet	
Colore	cromato e nero-chrome and black
Colours-Farbe	verchromt und schwarz
Materiale-Material	acciaio inox e plastica stainless steel and plastic Edelstahl und Kunststoff
Kg	0,655

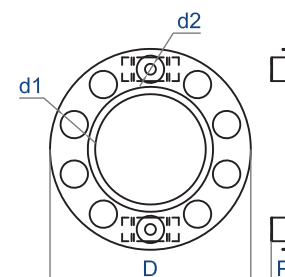

930/200 d|s-rh|lh-rechts+links

D \varnothing 425 mm	P 40 mm
d1 nr. 10	d1 \varnothing 58 mm
d2 nr. 2	d2 \varnothing 23 mm
Ventilata	no-nein
Ventilated-Belüftet	
Colore	cromato-chrome-verchromt
Colours-Farbe	
Materiale-Material	acciaio inox-stainless steel Edelstahl
Kg	1,155

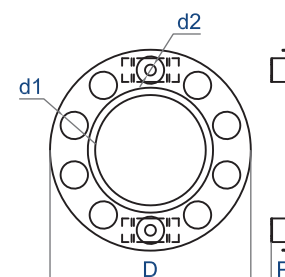

PRM/700 d|s-rh|lh-rechts+links

D \varnothing 425 mm	P 40 mm
d1 nr. 10	d1 \varnothing 58 mm
d2 nr. 2	d2 \varnothing 24 mm
Ventilata	no-nein
Ventilated-Belüftet	
Colore	silver-silver-Silber
Colours-Farbe	
Materiale-Material	acciaio inox-stainless steel Edelstahl
Kg	1,700

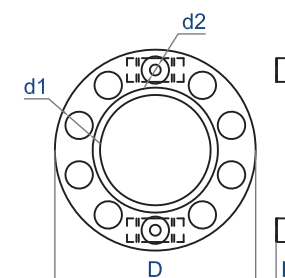

PRM/710 d|s-rh|lh-rechts+links

D \varnothing 425 mm	P 40 mm
d1 nr. 10	d1 \varnothing 58 mm
d2 nr. 2	d2 \varnothing 24 mm
Ventilata	no-nein
Ventilated-Belüftet	
Colore	cromato-chrome-verchromt
Colours-Farbe	
Materiale-Material	acciaio inox-stainless steel Edelstahl
Kg	1,700

applicabile a | suitable to | verwendbar für:

FH12-FH16 PRIMA SERIE | FIRST SERIES | ERSTE SERIE

0FH/670



0FH/675

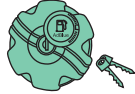

943/670

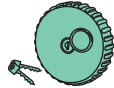

XF0/670

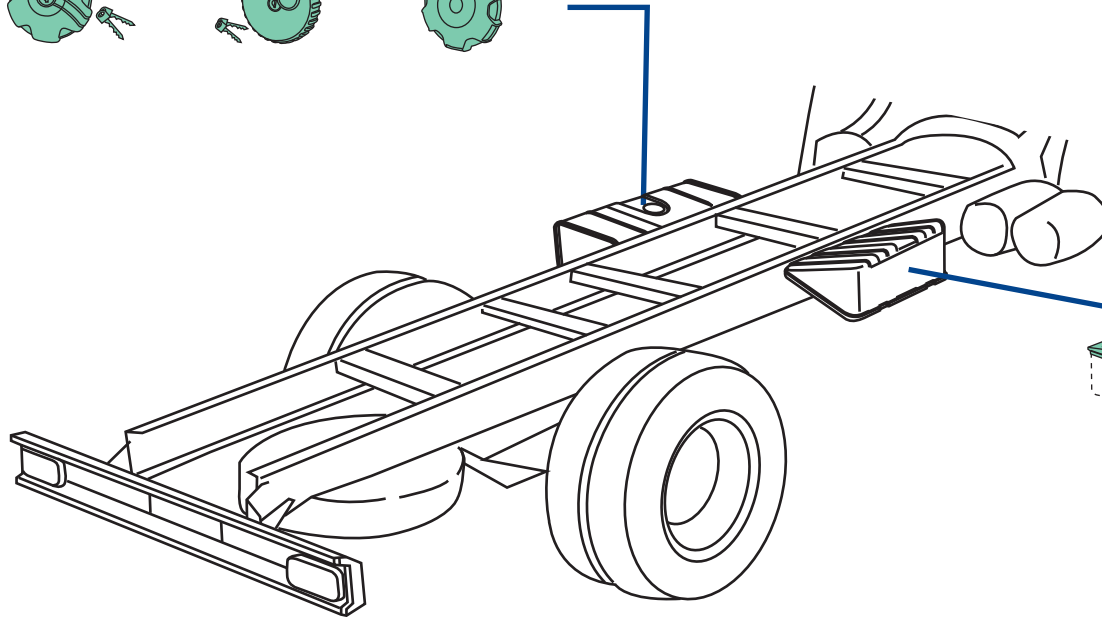

943/670

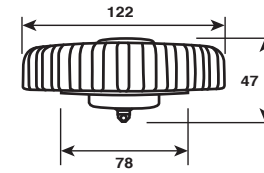

0FH/670

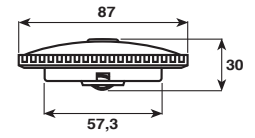

0FH/675

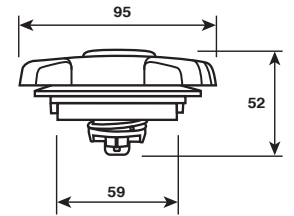

XF0/670

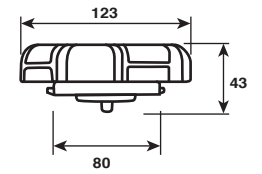

2FH/619

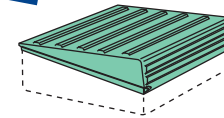

0FH/670
O.E.M. 20896946



0FH/675
O.E.M. 21281403



XF0/670
O.E.M. -



943/670
O.E.M. 20392752



2FH/619
O.E.M. 20507252



applicabile a | suitable to | verwendbar für 317

V12
F12

F12

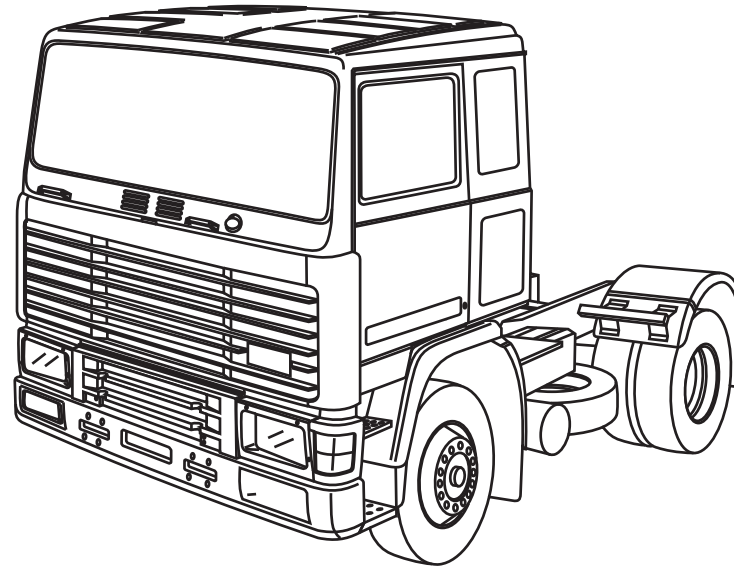
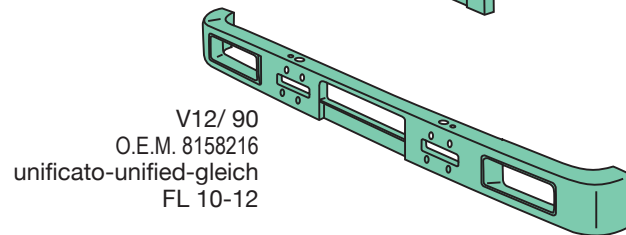
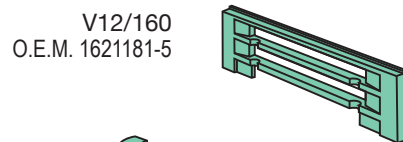
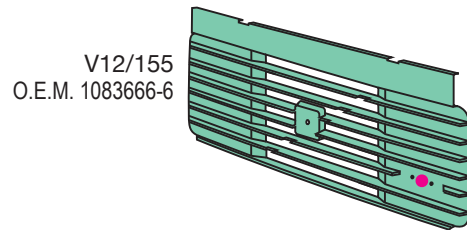
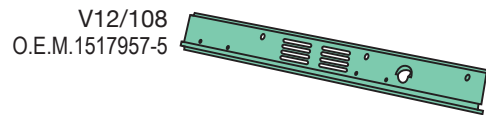
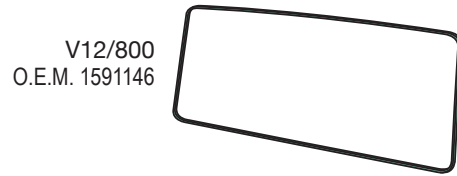

F12 V12/169
O.E.M. 1612331

INTERCOOLER V12/168
O.E.M. 1607898

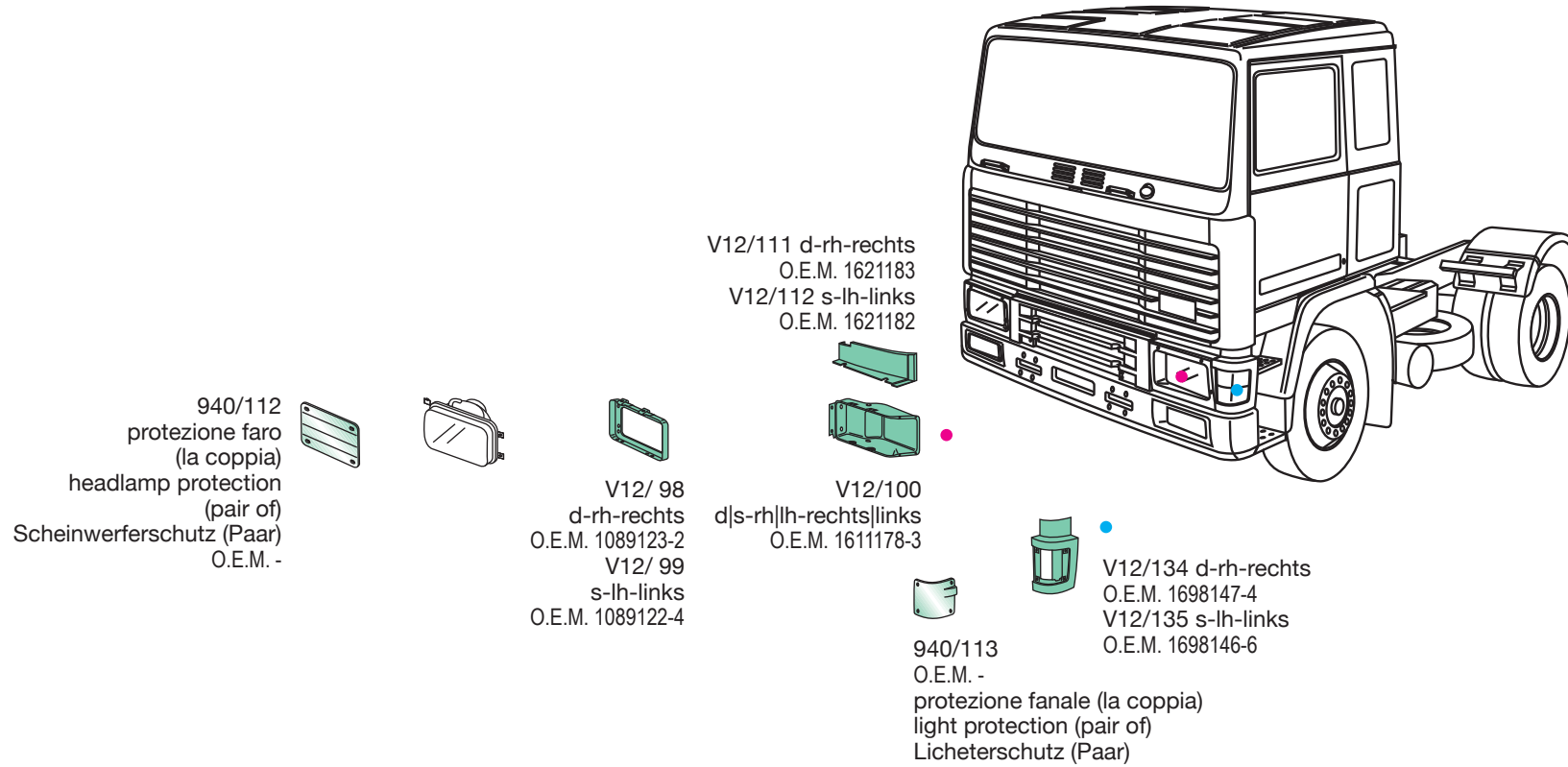

F12

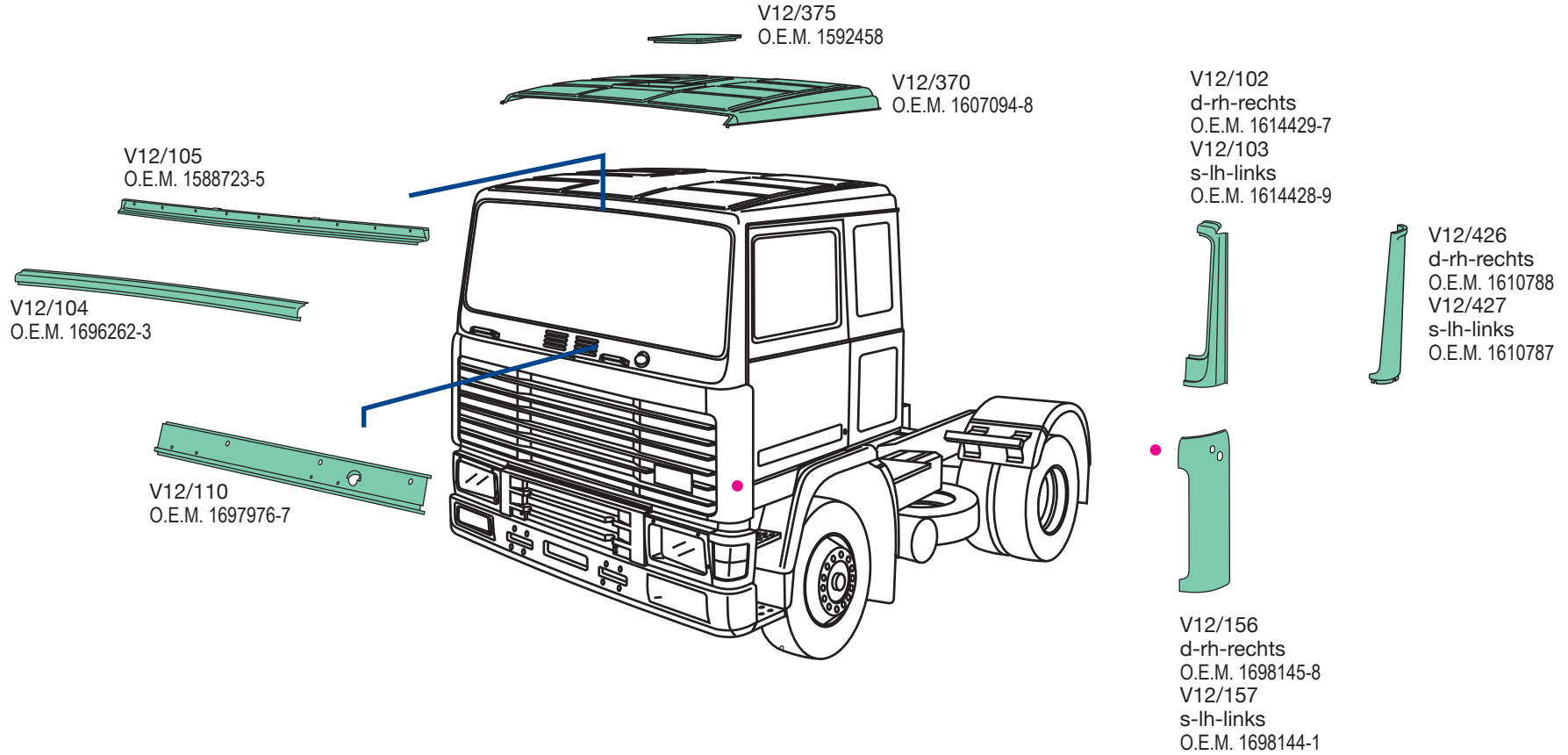

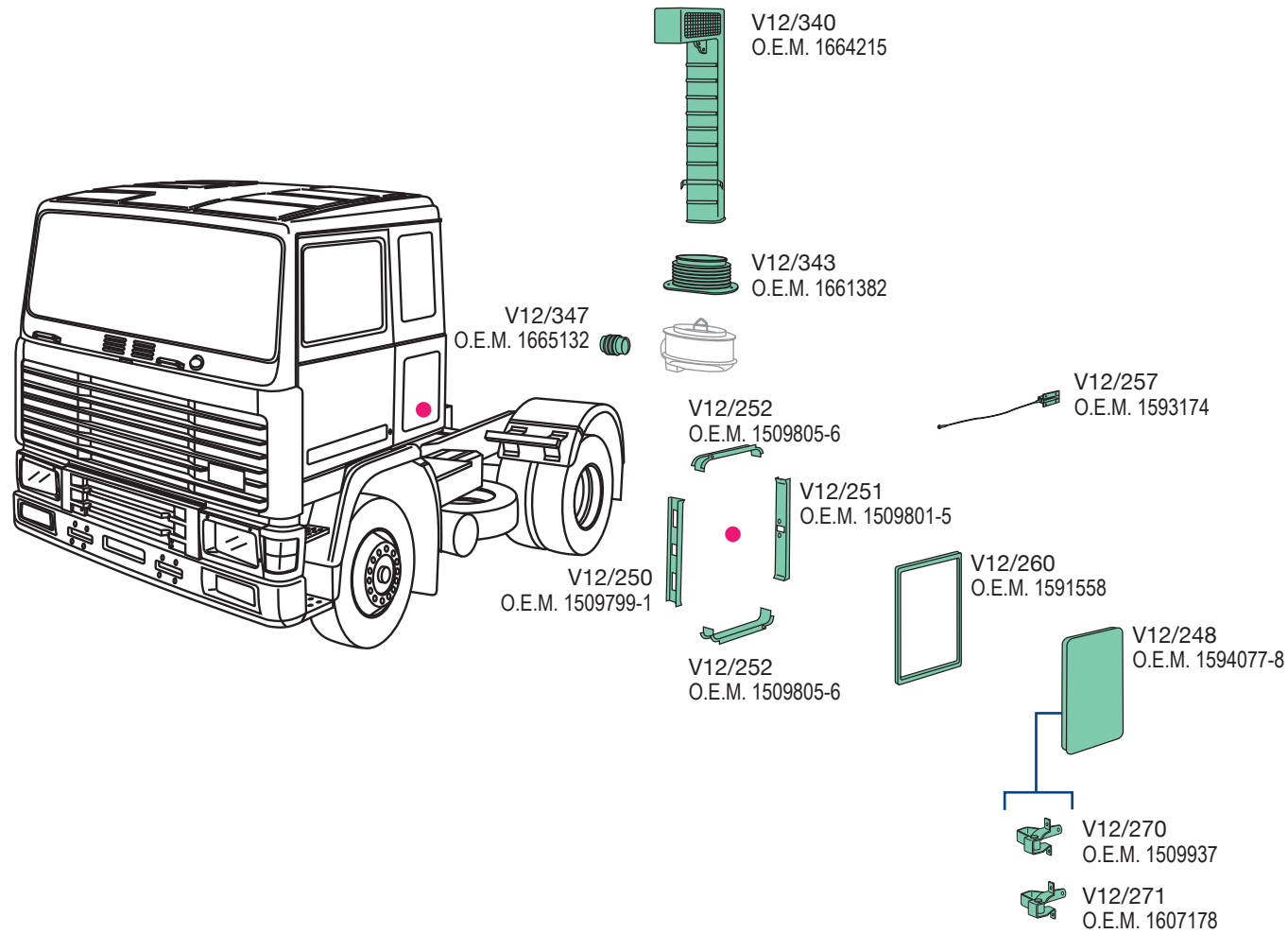

F12

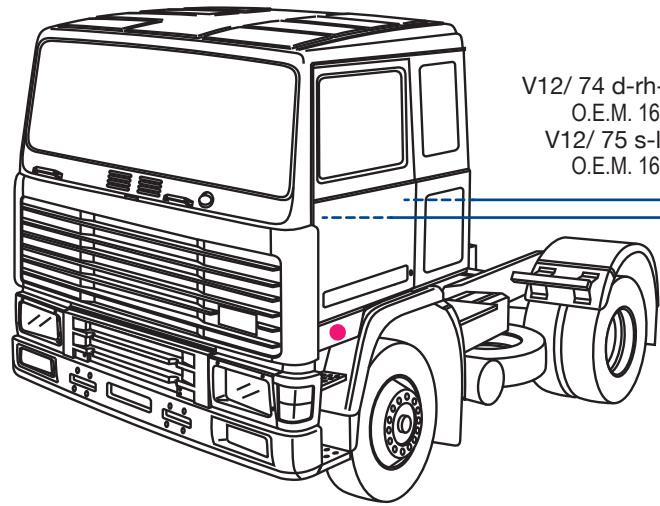

V12/ 74 d-rh-rechts
O.E.M. 1612622-9
V12/ 75 s-lh-links
O.E.M. 1612621-1

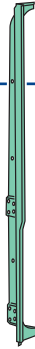

V12/210 d-rh-rechts
O.E.M. 1509924-5
V12/211 s-lh-links
O.E.M. 1509922-9



V12/ 2 d-rh-rechts
O.E.M. 1698651-5
V12/ 3 s-lh-links
O.E.M. 1698650-7
con cerniere
with hinges
mit Türscharniere

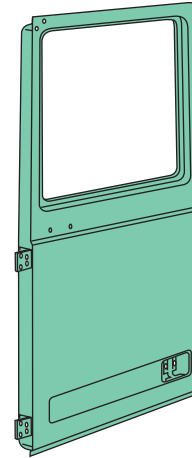

V12/ 6 d-rh-rechts
O.E.M. 1697968-4
V12/ 7 s-lh-links
O.E.M. 1697967-6
pannello porta esterno
door panel
äußeres Türblech

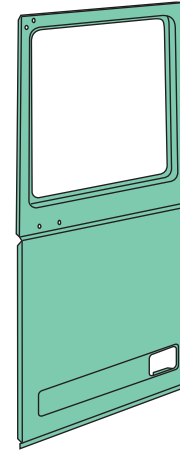

V12/ 86 d-rh-rechts
O.E.M. 1614459-4
V12/ 87 s-lh-links
O.E.M. 1614458-6



V12/ 82 d-rh-rechts
O.E.M. 1614461-0
V12/ 83 s-lh-links
O.E.M. 1614460-2

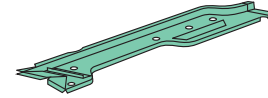

V12/ 84 d-rh-rechts
O.E.M. 1614457-8
V12/ 85 s-lh-links
O.E.M. 1614456-0

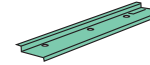

V12/ 4 d-rh-rechts
O.E.M. 1571118.
V12/ 5 s-lh-links
O.E.M. 1571117



V12/230 d-rh-rechts
O.E.M. 1509945-0
V12/231 s-lh-links
O.E.M. 1578428-3

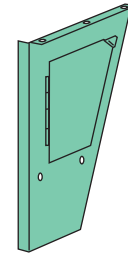

V12/242
d|s-rh|lh-rechts|links
O.E.M. 1509846-0

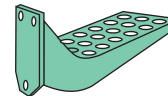

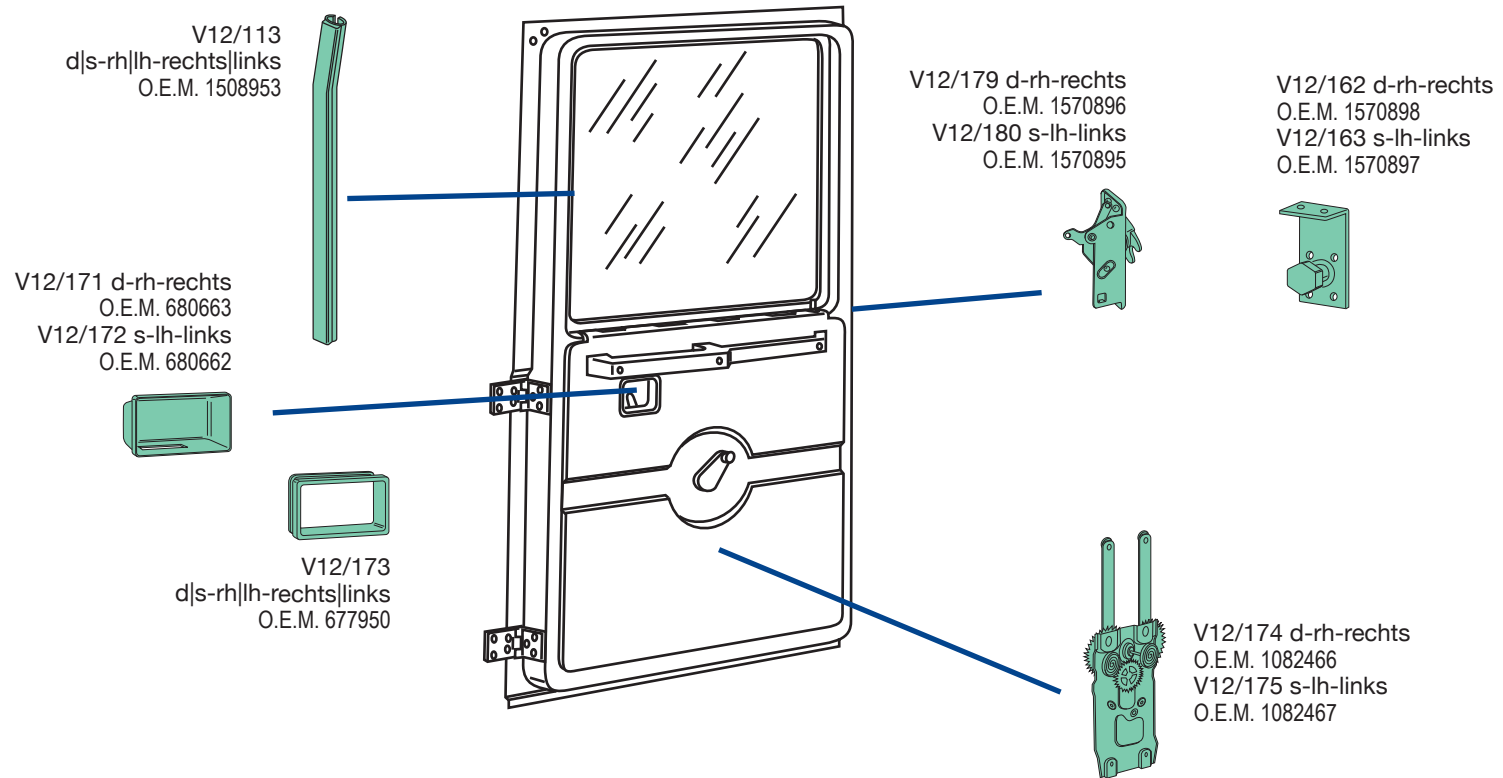

F12

PDS/360

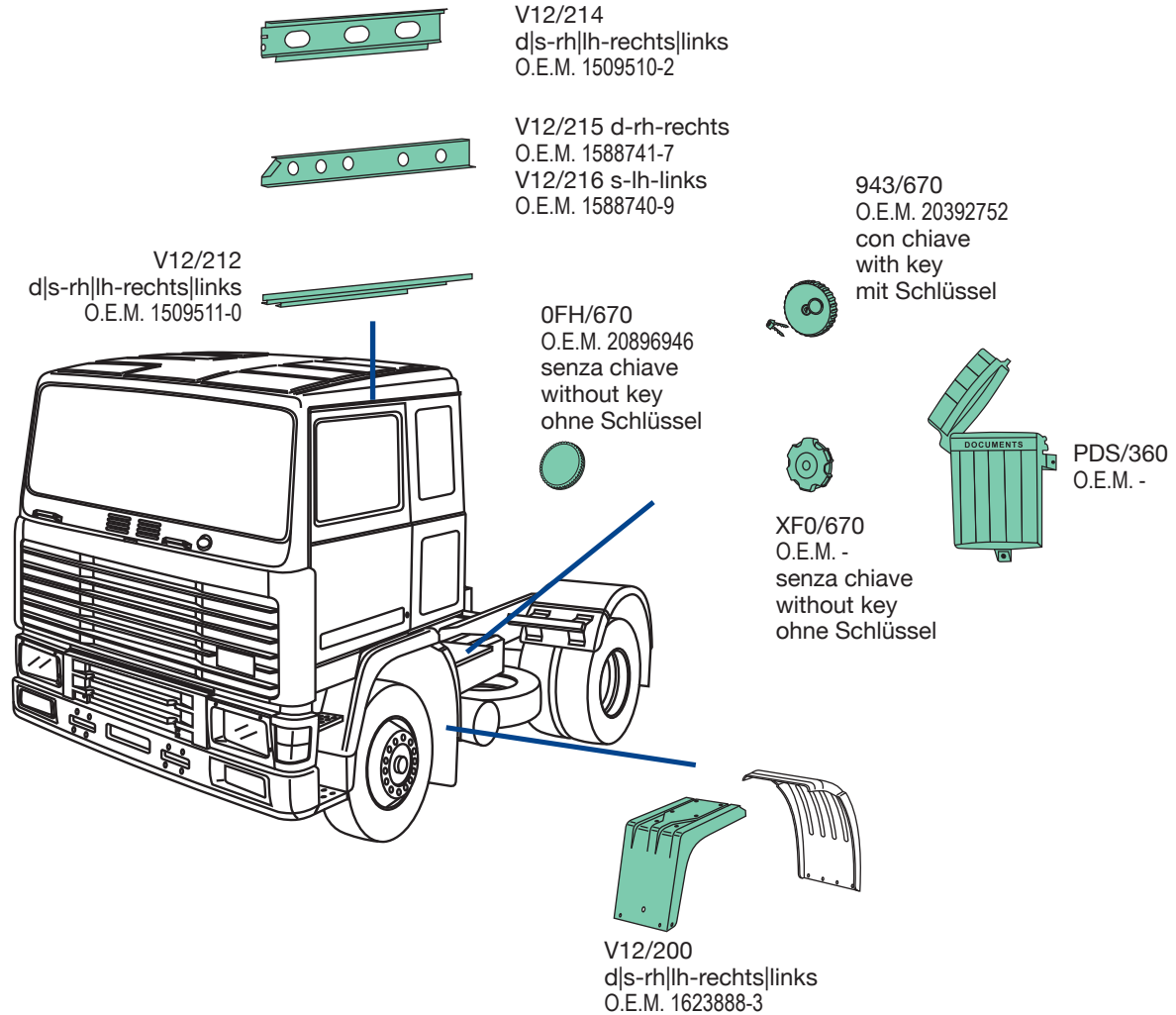
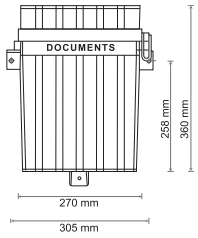

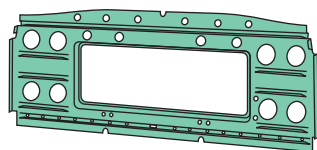

V12/316
O.E.M. 1570986-8

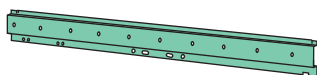

V12/317
O.E.M. 1614589-8

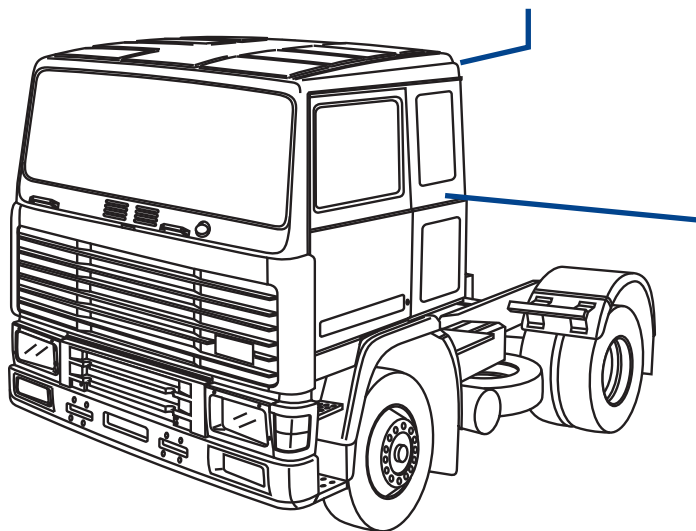

V12/246
d-rh-rechts
O.E.M. 1614490-9
cabina lunga
sleeper cab
langes Fhs.

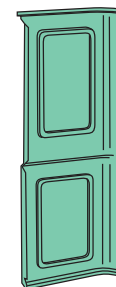

V12/243
d-rh-rechts
O.E.M. 1586124-4



V12/244
s-lh-links
O.E.M. 1586120-6

F12

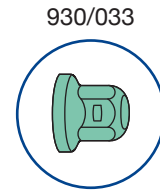
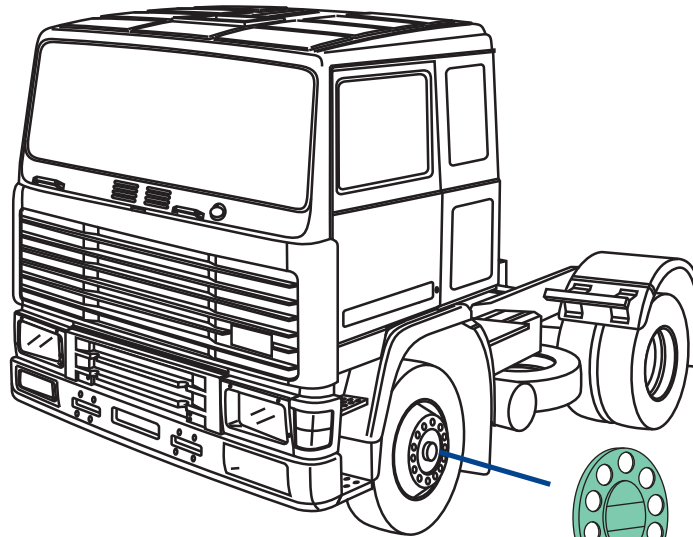

930/001
d-rh-rechts
930/002
s-lh-links



930/200
d|s-rh|lh
rechts|links

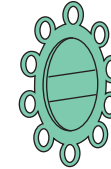

930/100
d-rh-rechts
930/101
s-lh-links



930/033
O.E.M. -



930/001
O.E.M. -
930/002
O.E.M. -



930/100
O.E.M. -
930/101
O.E.M. -



930/200
O.E.M. -

930/033-Tappo copri Bullone-Bolt cover-Radmutterkappen

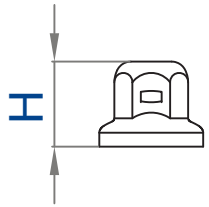

H	45 mm
Per bulloni \varnothing - bolt \varnothing	33 mm
Schlüsselweite \varnothing	
Colore	cromato-chrome-verchromt
Colours-Farbe	
Materiale-Material	acciaio inox-stainless steel Edelstahl
Kg	0,025

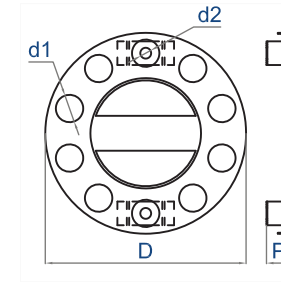

930/001 d-rh-rechts | 930/002 s-lh-links

D \varnothing 425 mm	P 50 mm
d1 nr. 10	d1 \varnothing 58 mm
d2 nr. 2	d2 \varnothing 23 mm
Ventilata	si-yes-Ja
Ventilated-Belüftet	
Colore	cromato e nero-chrome and black verchromt und schwarz
Colours-Farbe	
Materiale-Material	acciaio inox e plastica stainless steel and plastic Edelstahl und Kunststoff
Kg	1,230

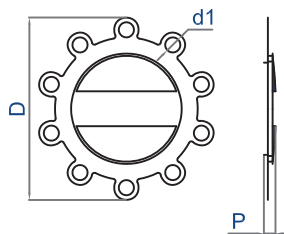

930/100 d-rh-rechts | 930/101 s-lh-links

D \varnothing 387 mm	P 30 mm
d1 nr. 10	d1 \varnothing 32 mm
Ventilata	si-yes-Ja
Ventilated-Belüftet	
Colore	cromato e nero-chrome and black verchromt und schwarz
Colours-Farbe	
Materiale-Material	acciaio inox e plastica stainless steel and plastic Edelstahl und Kunststoff
Kg	0,655

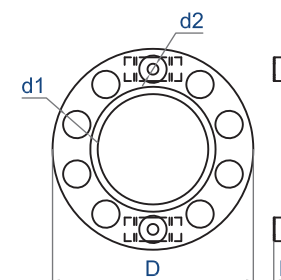

930/200 d|s-rh|lh-rechts+links

D \varnothing 425 mm	P 40 mm
d1 nr. 10	d1 \varnothing 58 mm
d2 nr. 2	d2 \varnothing 23 mm
Ventilata	no-nein
Ventilated-Belüftet	
Colore	cromato-chrome-verchromt
Colours-Farbe	
Materiale-Material	acciaio inox-stainless steel Edelstahl
Kg	1,155

gallery

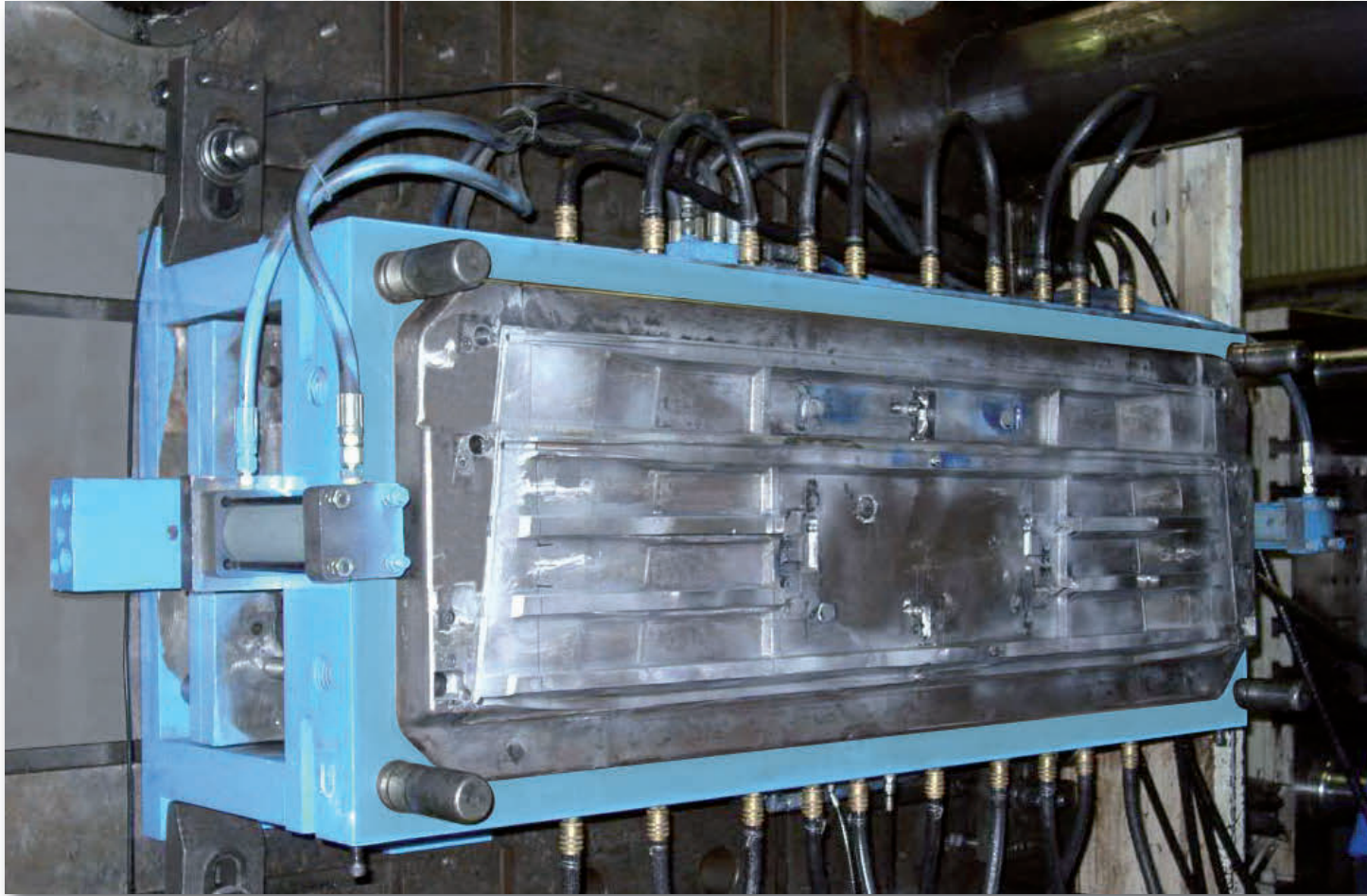



applicabile a | suitable to | verwendbar für 329

3FX
FMX Euro 5
(2010→2012)

gallery

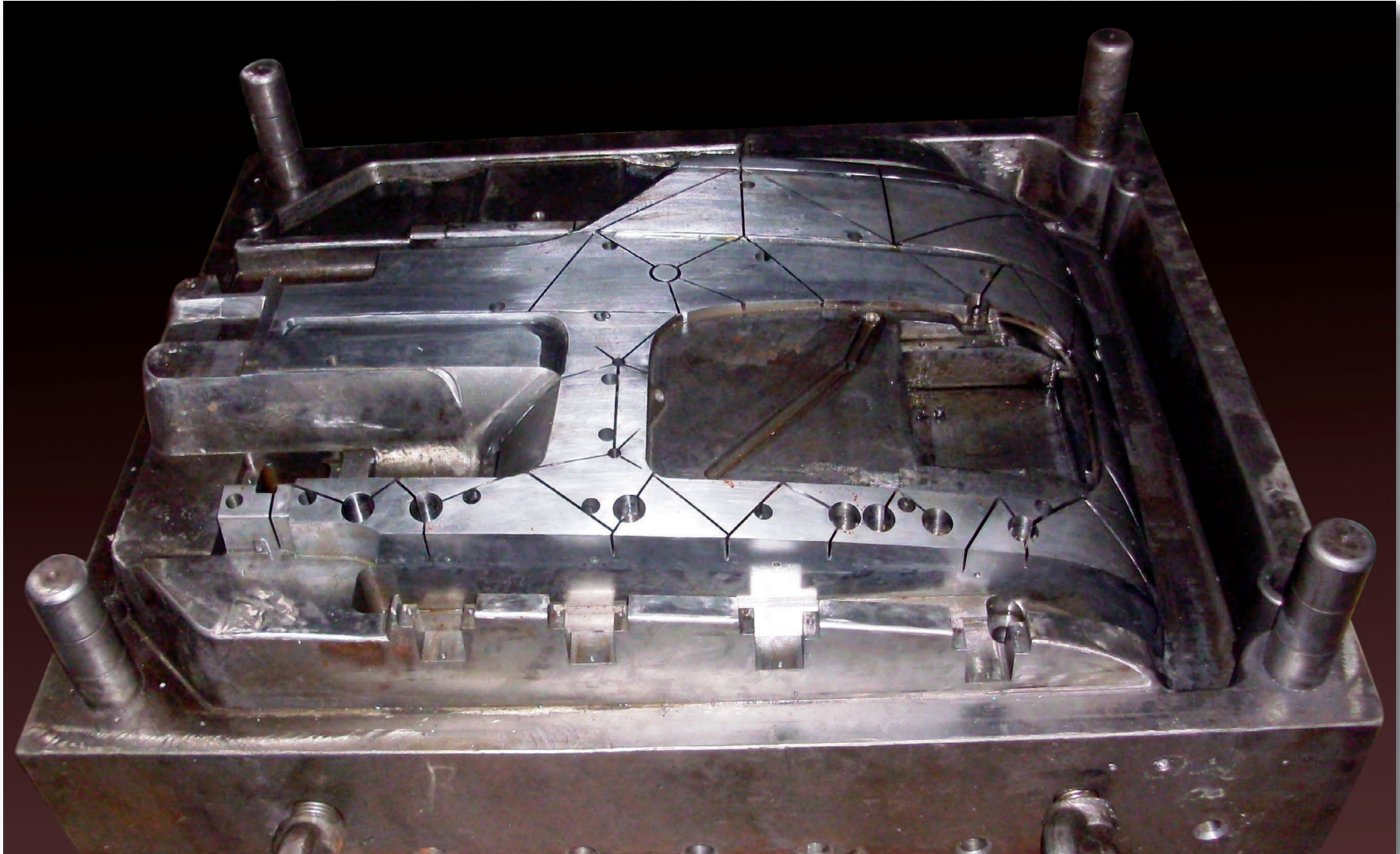

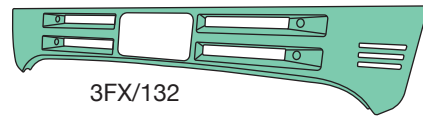
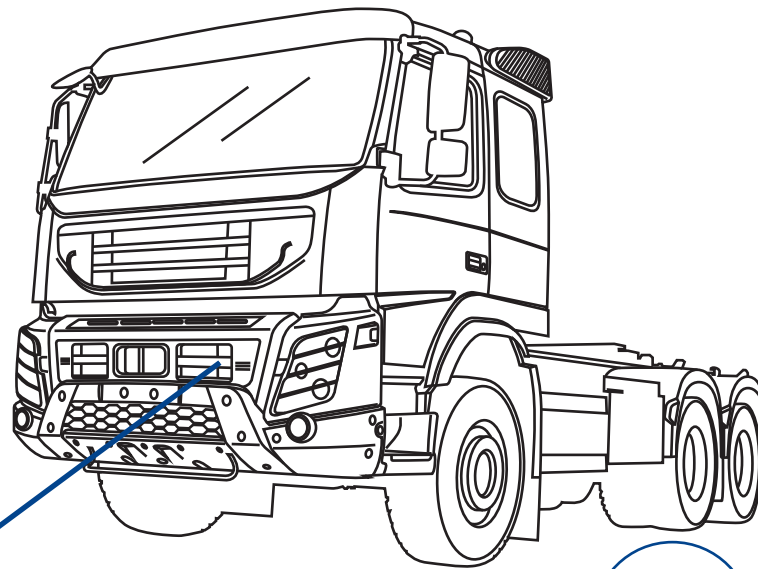

3FX/132

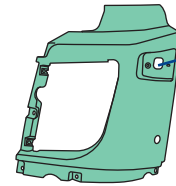

3FX/130 d-rh-rechts
3FX/131 s-lh-links



3FH/608 d-rh-rechts
3FH/609 s-lh-links

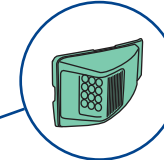

3FH/610 d-rh-rechts
3FH/611 s-lh-links



3FH/608
O.E.M. 21478751
3FH/609
O.E.M. 21448885



3FH/610
O.E.M. 82114500
3FH/611
O.E.M. 84139937



3FX/130
O.E.M. 21404043
3FX/131
O.E.M. 21404042



3FX/132
O.E.M. 82266404

applicabile a | suitable to | verwendbar für:

FMX Euro 5

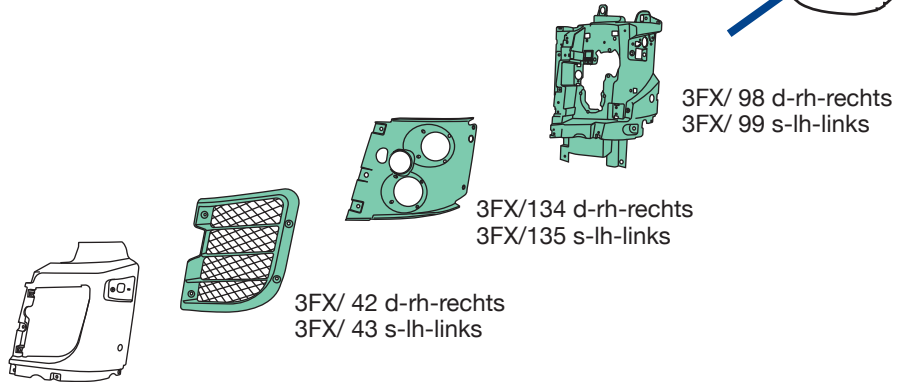
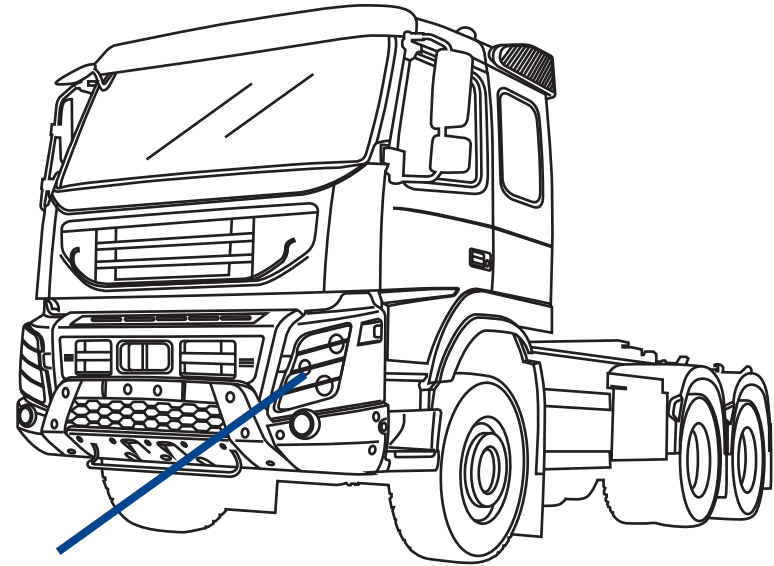

3FX/ 42
O.E.M. 82266040
3FX/ 43
O.E.M. 82266039



3FX/ 98
O.E.M. 82424434
3FX/ 99
O.E.M. 82423778



3FX/134
O.E.M. 82266416
3FX/135
O.E.M. 82266415

FMX Euro 5

a 2FH/ 50
d|s-rh|lh
rechts|links

b

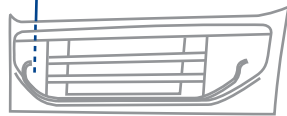

2FH/162 d-rh-rechts
2FH/163 s-lh-links

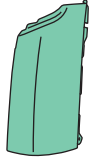

2FM/160 d-rh-rechts
2FM/161 s-lh-links

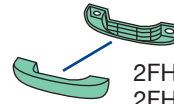

2FH/110 d-rh-rechts
2FH/111 s-lh-links

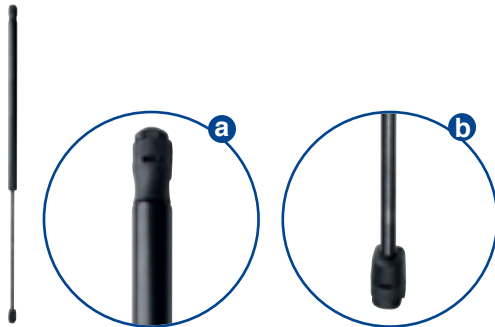
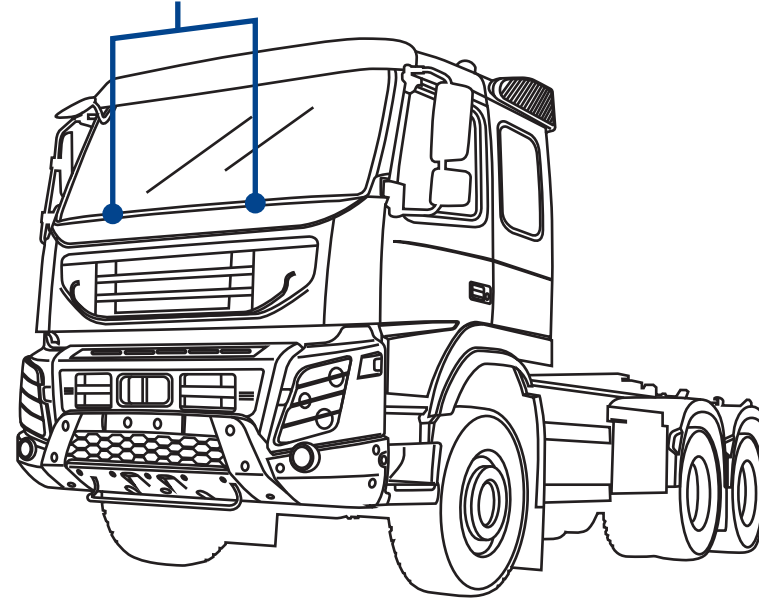

2FH/ 50
O.E.M. 20379348



2FH/110
O.E.M. 3175367+3175366
2FH/111
O.E.M. 20383543+3175366



2FH/162
O.E.M. 20529672
2FH/163
O.E.M. 20529668



2FM/160
O.E.M. 20379172
2FM/161
O.E.M. 20379171

applicabile a | suitable to | verwendbar für:

FMX Euro 5

2FM/ 2 d-rh-rechts
2FM/ 3 s-lh-links
con cerniere
with hinges
mit Türscharniere



0FH/197 d-rh-rechts
0FH/198 s-lh-links

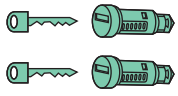

0FH/196
d|s-rh|lh-rechts|links

0FH/194 d-rh-rechts
0FH/195 s-lh-links

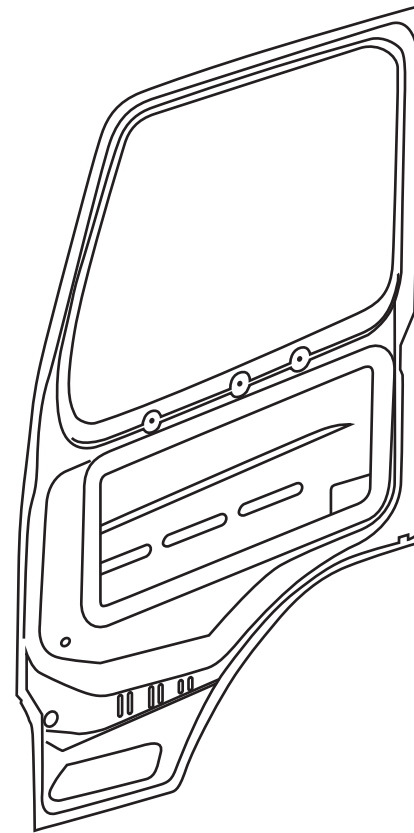
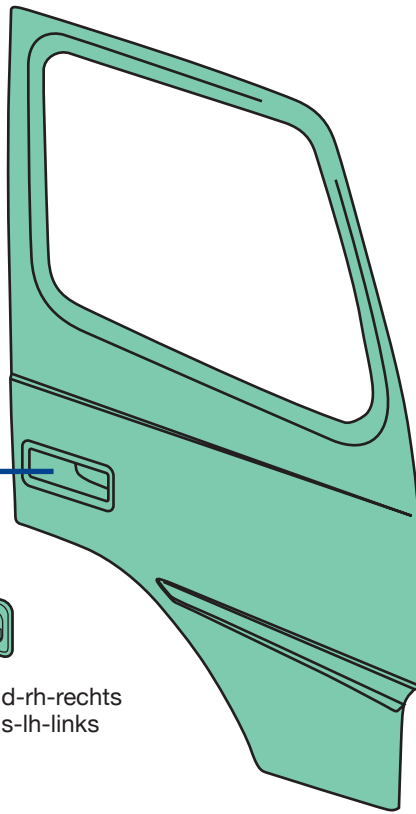

0FM/174 d-rh-rechts
0FM/175 s-lh-links
elettrico, senza motorino
electric, without motor
elektrisch, ohne Motor

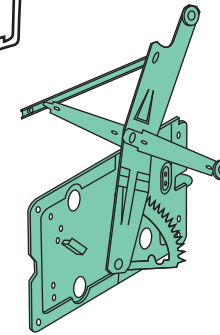

0FH/194
O.E.M. 20398467
0FH/195
O.E.M. 20398466



0FH/196
O.E.M. 3090484



0FH/197
O.E.M. -
0FH/198
O.E.M. -



2FM/ 2
O.E.M. 20360850
2FM/ 3
O.E.M. 20360849



0FM/174
O.E.M. -
0FM/175
O.E.M. -

FMX Euro 5

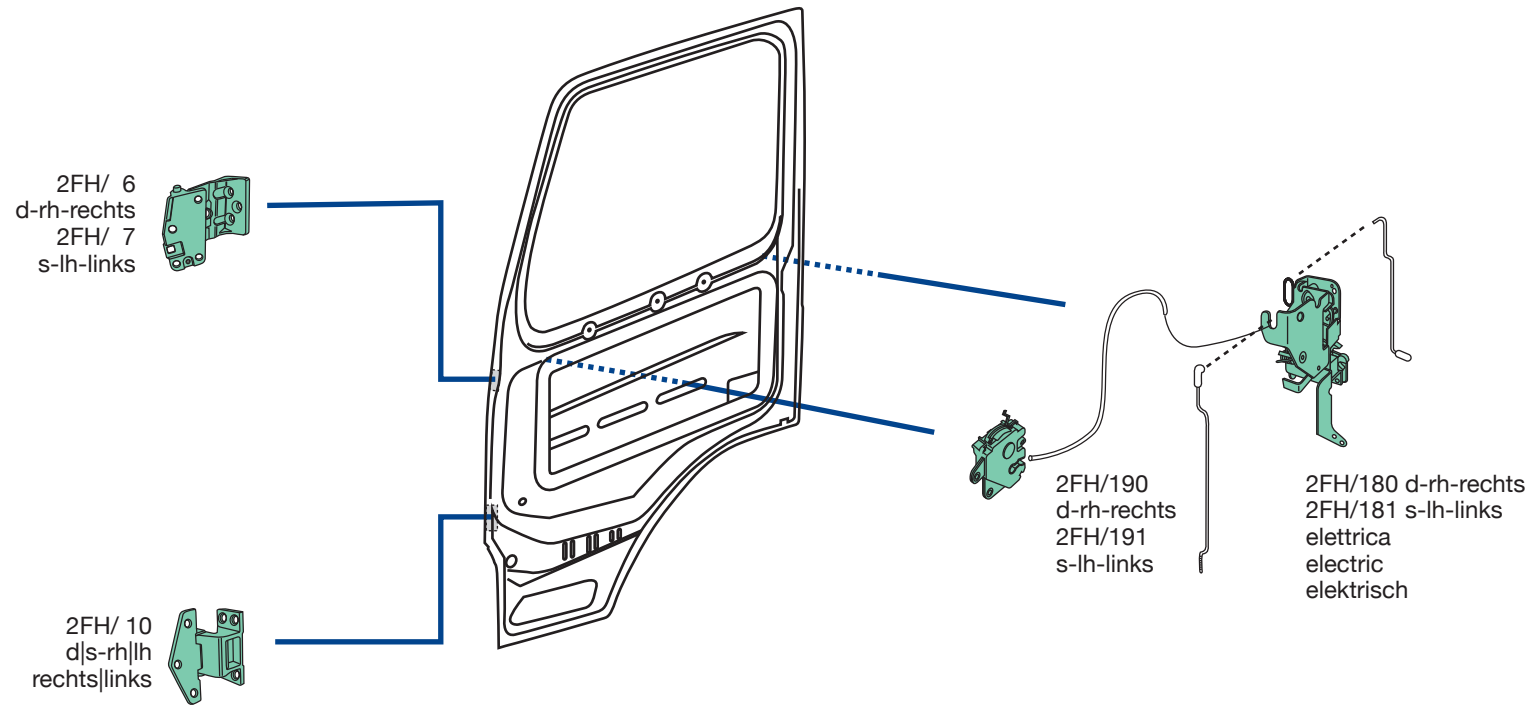

2FH/ 6
O.E.M. 20398136
2FH/ 7
O.E.M. 20398135



2FH/ 10
O.E.M. 20372039



2FH/180
O.E.M. 21505894
2FH/181
O.E.M. 21505893



2FH/190
O.E.M. 20570722
2FH/191
O.E.M. 20570721

applicabile a | suitable to | verwendbar für:

FMX Euro 5

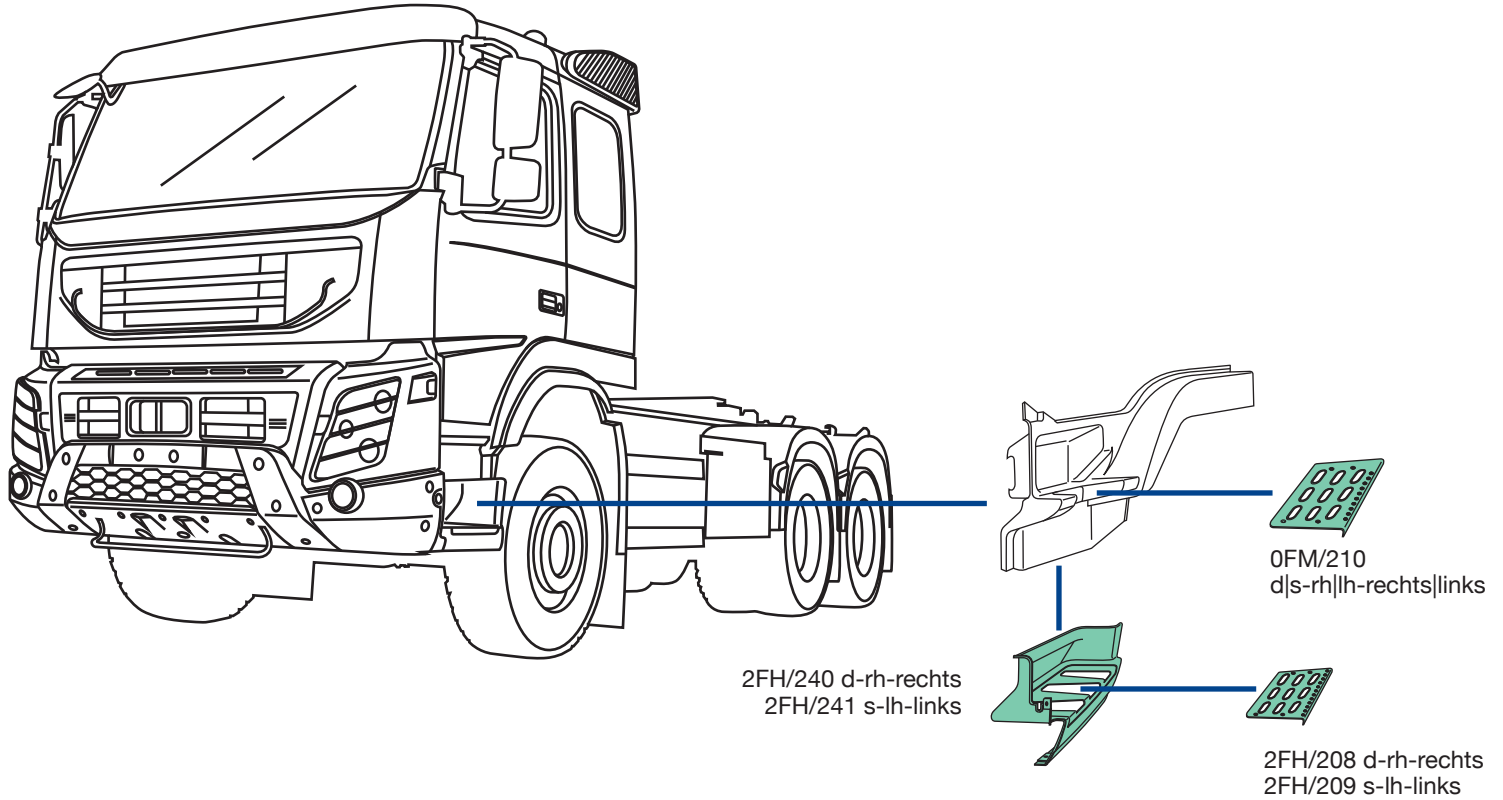

0FM/210
O.E.M. 1063726



2FH/208
O.E.M. 20360789
2FH/209
O.E.M. 20360788



2FH/240
O.E.M. 20529640
2FH/241
O.E.M. 20529638

FMX Euro 5

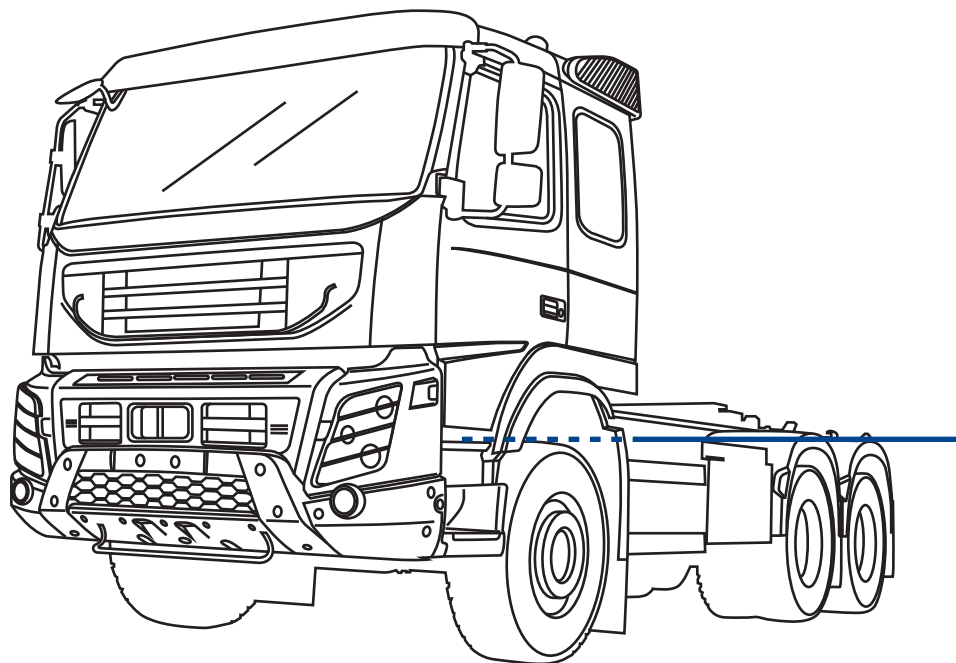

0FM/198 d-rh-rechts
0FM/199 s-lh-links

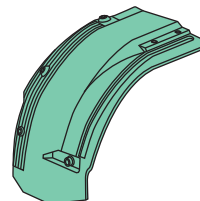

2FH/325
d|s-rh|lh
rechts|links

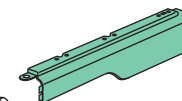

0FM/206 d-rh-rechts
0FM/207 s-lh-links

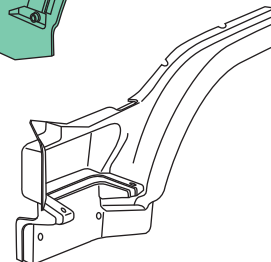

0FM/198
O.E.M. 8191781
0FM/199
O.E.M. 8191780



0FM/206
O.E.M. 20530083
0FM/207
O.E.M. 20530082



2FH/325
O.E.M. 20453900

applicabile a | suitable to | verwendbar für:

FMX Euro 5

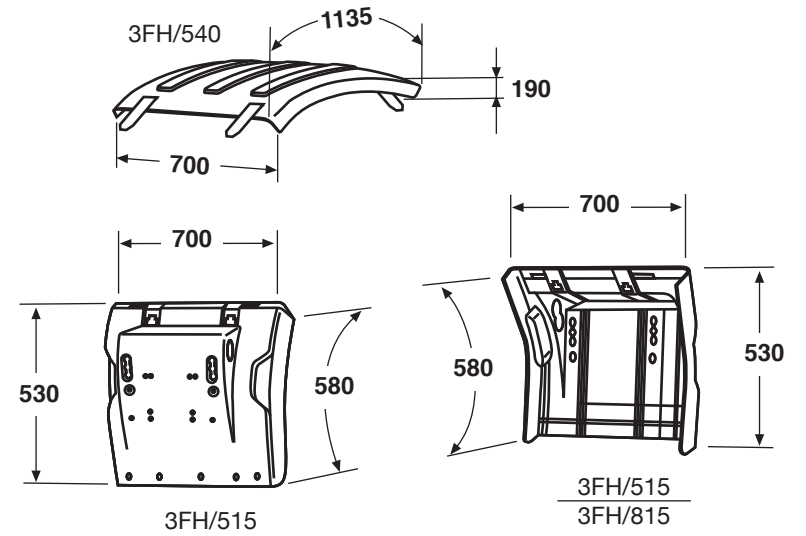
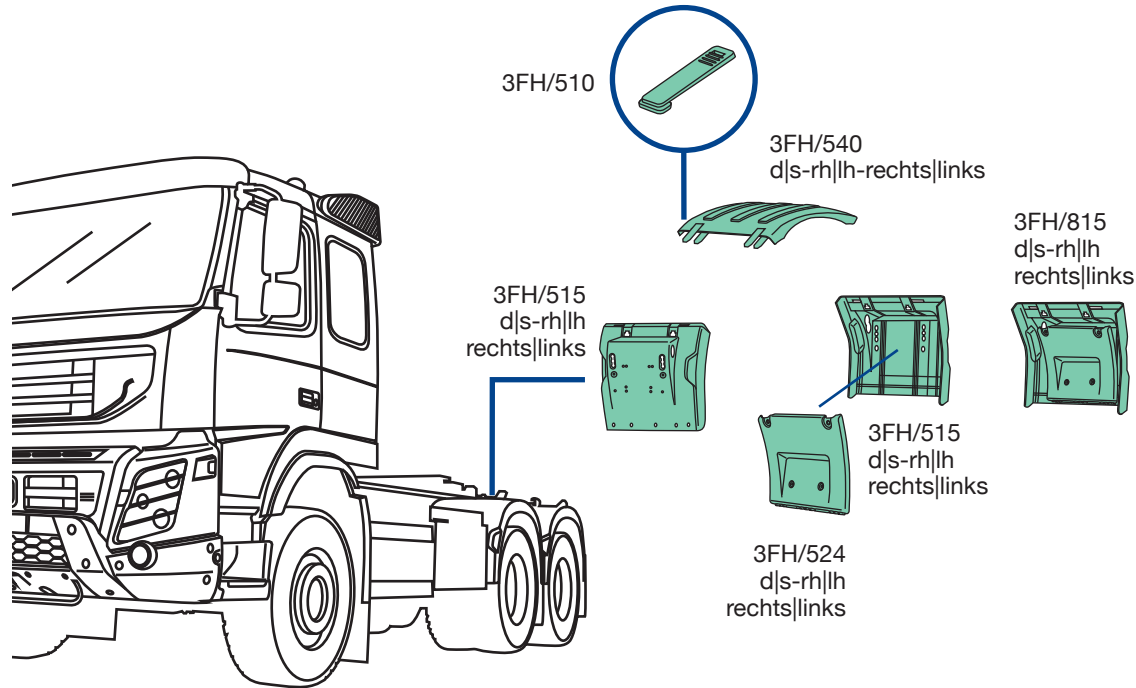

3FH/510
O.E.M. 21094457



3FH/524
O.E.M. 21094447

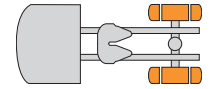

3FH/540
O.E.M. 21094390
d|s-rh|lh-rechts|links
nero, semipiatta,
con cinghietti
black, semi-flat,
with stretchers
schwarz, halbflach,
mit Spanngummi

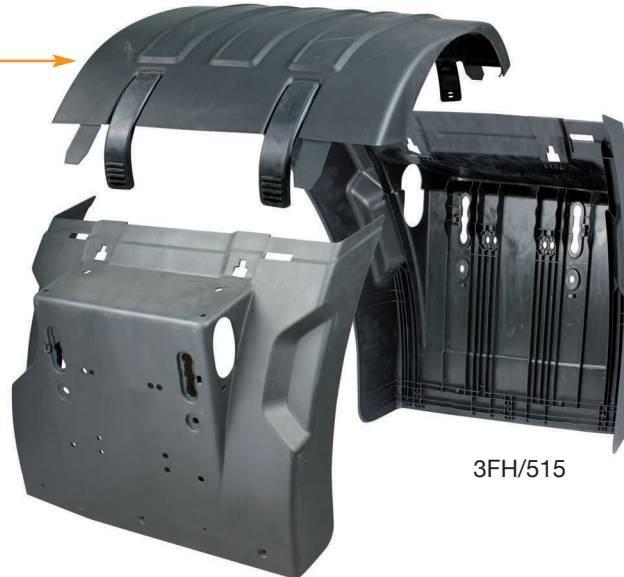

3FH/515
O.E.M. 21094391
d|s-rh|lh-rechts|links
nero-black-schwarz

3FH/515

3FH/815
O.E.M. -
d|s-rh|lh-rechts|links
nero-black-schwarz



3FH/815 O.E.M. -

**KIT
Satz**



A

B

C

D

E

F

G

H

i

3FH/515
O.E.M. 21094391
1 pz.-pcs.-Stk.

3FH/524
O.E.M. 21094447
1 pz.-pcs.-Stk.

3FH/526
O.E.M. 21094456 +
21094454
2 pz.-pcs.-Stk.

O.E.M. 21094449
1 pz.-pcs.-Stk.

O.E.M. 21094453
2 pz.-pcs.-Stk.

O.E.M. 21094451
6 pz.-pcs.-Stk.

O.E.M. 992426
2 pz.-pcs.-Stk.

O.E.M. 992423
6 pz.-pcs.-Stk.

O.E.M. 60112154
2 pz.-pcs.-Stk.

applicabile a | suitable to | verwendbar für:

FMX Euro 5

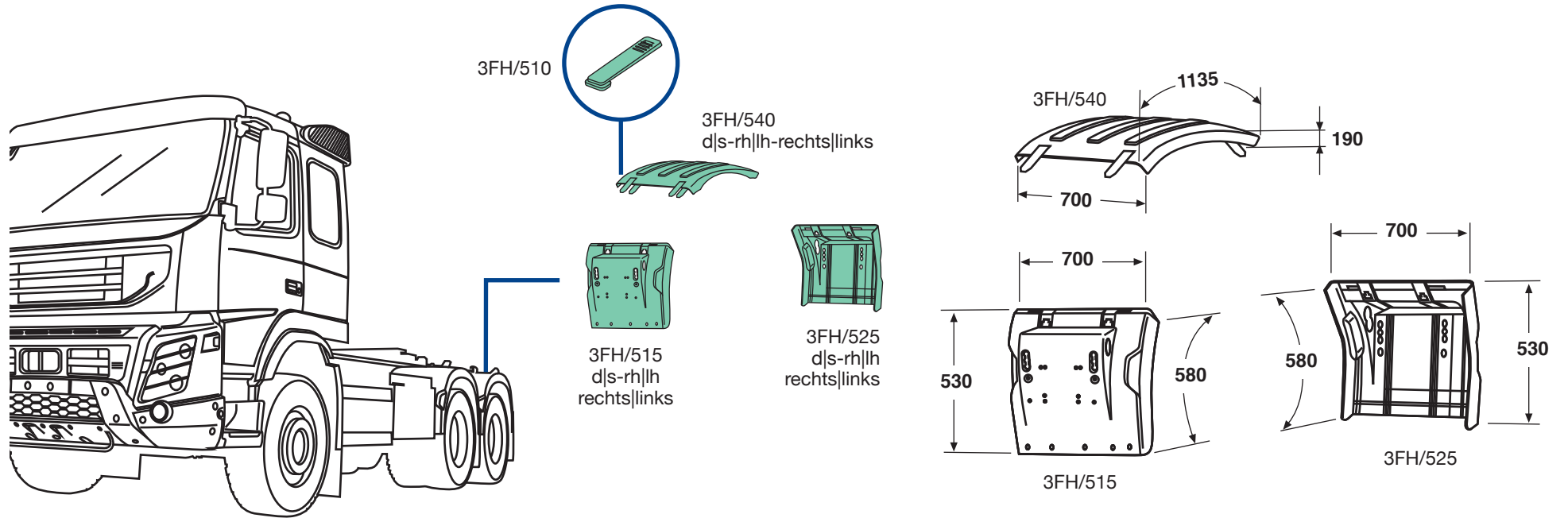

3FH/510
O.E.M. 21094457

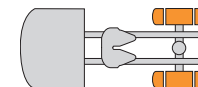

3FH/540
 O.E.M. 21094390
 d|s-rh|lh-rechts|links
 nero, semipiatta, con cinghietti
 black, semi-flat, with stretchers
 schwarz, halbflach, mit Spanngummi



3FH/515
 O.E.M. 21094391
 d|s-rh|lh-rechts|links
 nero-black-schwarz

3FH/525
 O.E.M. 21094394
 d|s-rh|lh-rechts|links
 nero, senza anti-spray
 black, without anti-spray
 schwarz, ohne Spritzschutz



applicabile a | suitable to | verwendbar für:

FMX Euro 5

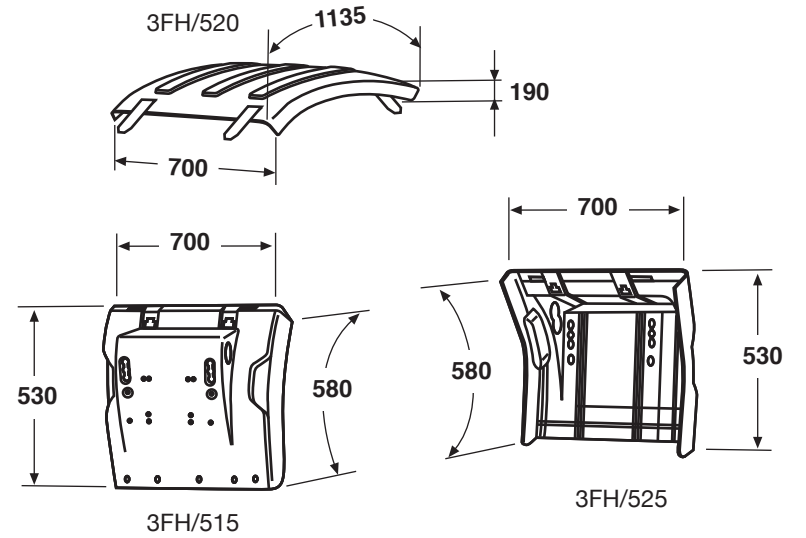
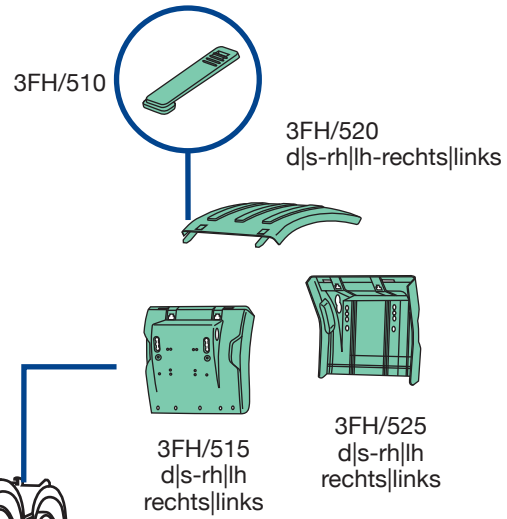
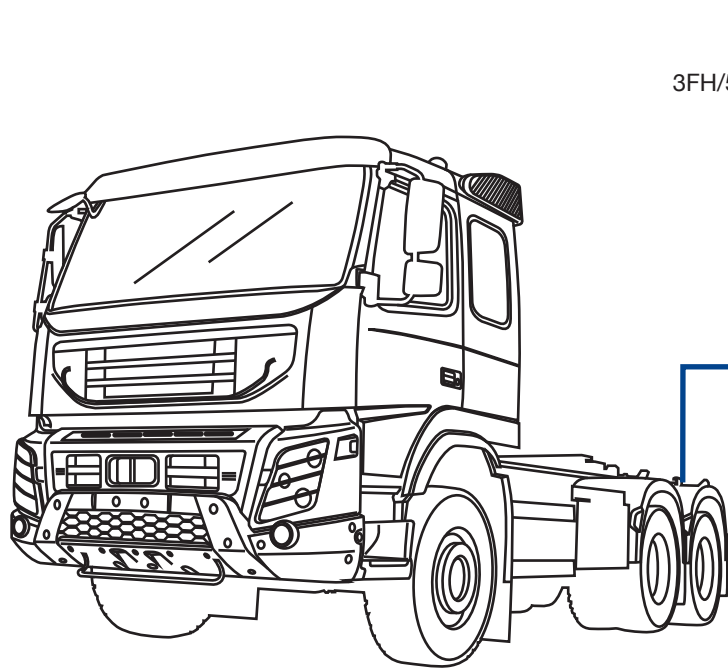

3FH/510
O.E.M. 21094457

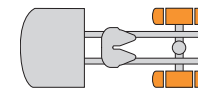

3FH/520
 O.E.M. 21094388
 d|s-rh||h-rechts|links
 nero, semipiatta, con cinghietti
 black, semi-flat, with stretchers
 schwarz, halbflach, mit Spanngummi



3FH/525
 O.E.M. 21094394
 d|s-rh||h-rechts|links
 nero, senza anti-spray
 black, without anti-spray
 schwarz, ohne Spritzschutz



3FH/515
 O.E.M. 21094391
 d|s-rh||h-rechts|links
 nero-black-schwarz

FMX Euro 5



2FH/515
d|s-rh|lh
rechts|links

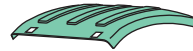

2FH/520
d|s-rh|lh
rechts|links

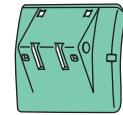
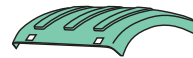

2FH/505
d|s-rh|lh
rechts|links



2FH/518
d|s-rh|lh
rechts|links
con staffe
(2FH/517 2 pz.)
anteriore|posteriore
with brackets
front|rear
mit Klemme
Vorderteil|Hinterteil

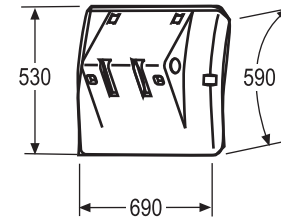
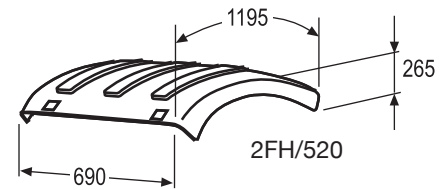
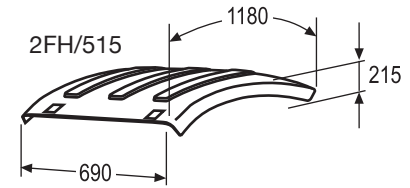

2FH/505

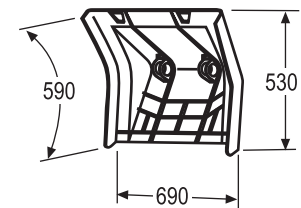

2FH/518

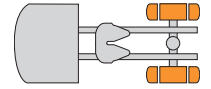

2FH/515
 O.E.M. 20936759
 d|s-rh|lh-rechts|links
 nero, semipiatta, senza cinghietti
 black, semi-flat, without stretchers
 schwarz, halbfach, ohne Spanngummi



2FH/518
 O.E.M. 20392599
 d|s-rh|lh-rechts|links
 nero, senza anti-spray, con staffe
 black, without anti-spray, with brackets
 schwarz, ohne Spritzschutz, mit Klemme



2FH/520
 O.E.M. 20936769
 d|s-rh|lh-rechts|links
 nero, circolare, senza cinghietti
 black, circular, without stretchers
 schwarz, kreisförmig, ohne Spanngummi



2FH/518



2FH/505
 O.E.M. 20392544
 d|s-rh|lh-rechts|links
 nero, senza staffe
 black, without brackets
 schwarz, ohne Klemme



2FH/505

applicabile a | suitable to | verwendbar für:

FMX Euro 5

adattabile a - suitable to: - passend für:

(**) 3FH/515-3FH/525

(°) adattabile a 2FH/505-2FH/518
suitable to 2FH/505-2FH/518
passend für 2FH/505-2FH/518

PRM/497 (°)

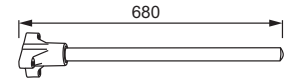

3FH/532(**)

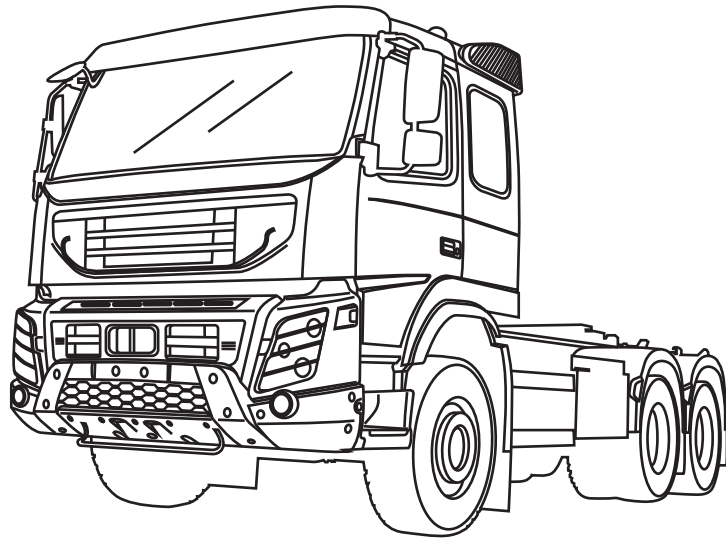
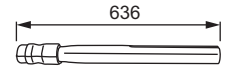

PRM/497(°)
d|s-rh|lh
rechts|links



3FH/532(**)
d|s-rh|lh-rechts|links

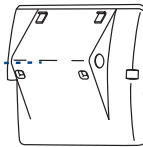
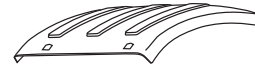

3FH/532(**)
d|s-rh|lh-rechts|links

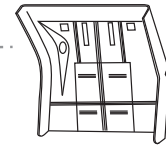

3FH/532
O.E.M. 22192015

PRM/497
O.E.M. 1079959

adattabile a: - suitable to: - passend für:
(*) 2FH/505

applicabile a | suitable to | verwendbar für:

FMX Euro 5

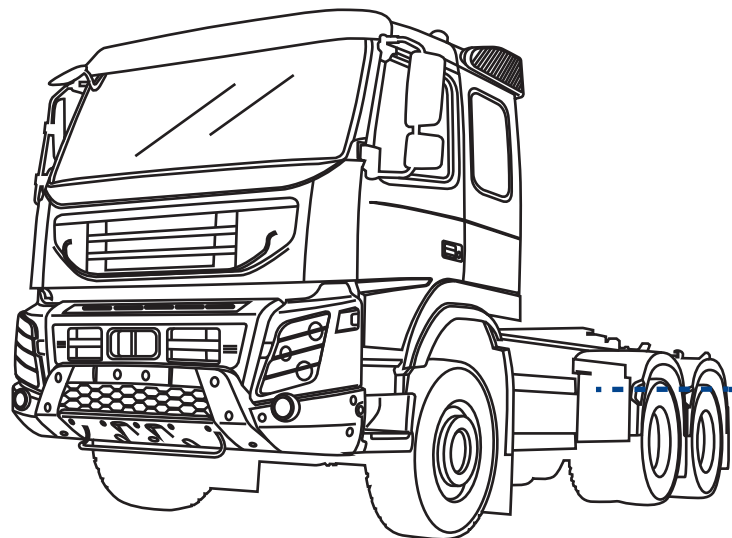

OFH/526
d|s-rh|lh
rechts|links

OFH/527
d|s-rh|lh
rechts|links

OFH/522(*)
d|s-rh|lh
rechts|links

OFH/522(*)
d|s-rh|lh-rechts|links

OFH/522(*)

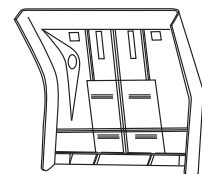
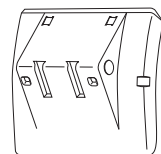
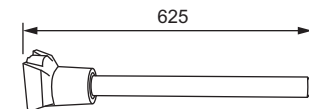

OFH/522
O.E.M. 20466894



OFH/526
O.E.M. 20382890



OFH/527
O.E.M. 20383038

applicabile a | suitable to | verwendbar für:

FMX Euro 5

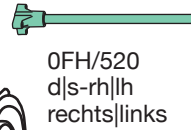
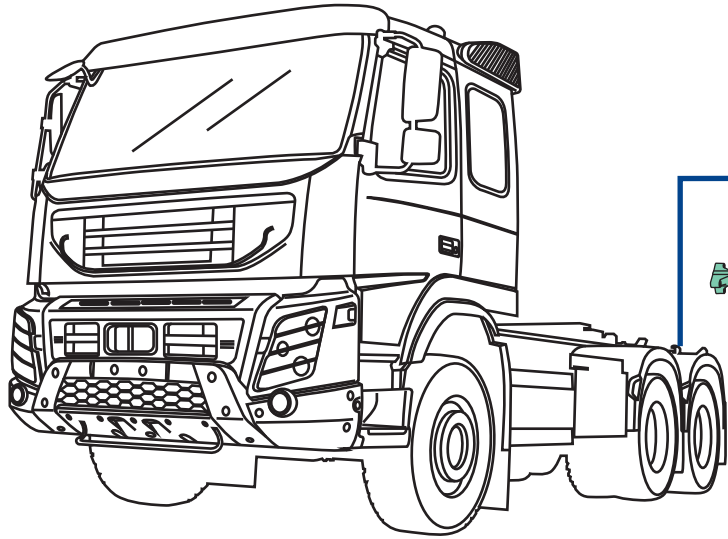

OFH/520
d|s-rh|lh
rechts|links

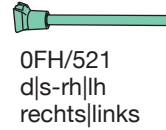
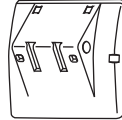

OFH/521
d|s-rh|lh
rechts|links

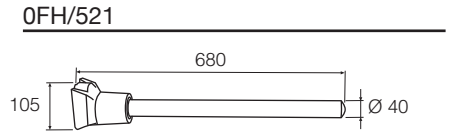
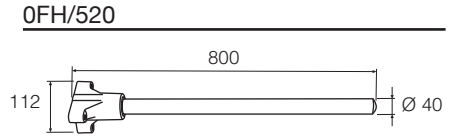
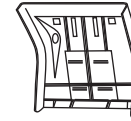

OFH/520
O.E.M. 8154385



OFH/521
O.E.M. 20466895

FMX Euro 5

(*) Applicabile con il cinghietto 2FH/510
Applied with stretcher 2FH/510
bestückt mit 2FH/510

(°) Applicabile con il cinghietto PRM/515
Applied with stretcher PRM/515
bestückt mit PRM/515

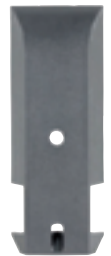
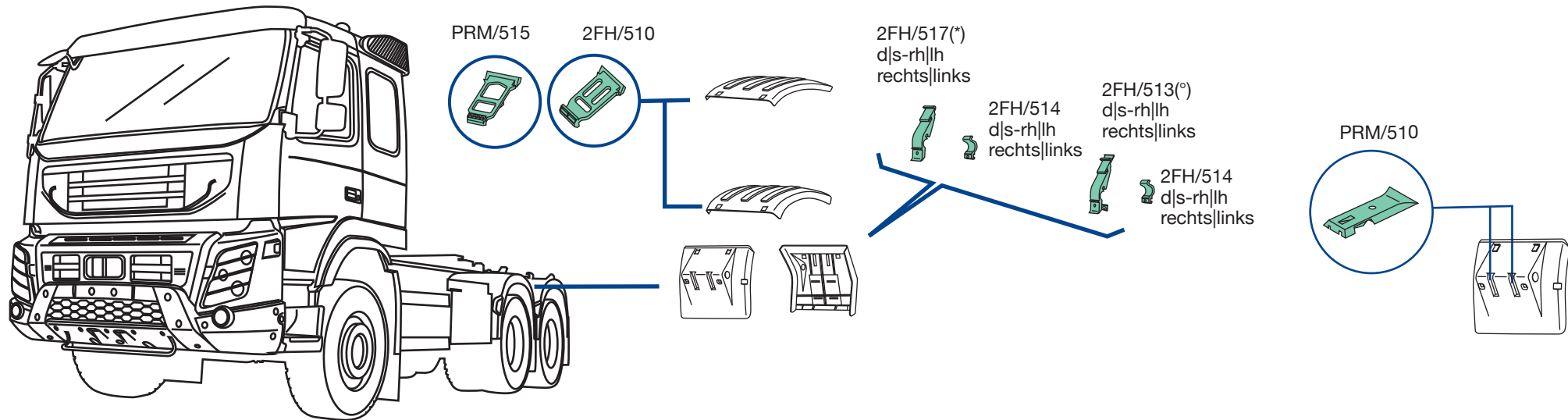

PRM/510
O.E.M. 20721840



PRM/515
O.E.M. 20498623



2FH/510
O.E.M. 1079981



2FH/513
O.E.M. 20583434



2FH/514
O.E.M. 20583440



2FH/517
O.E.M. 3987252

applicabile a | suitable to | verwendbar für:

FMX Euro 5

2FH/610 d|s-rh|lh-rechts|links

2002→

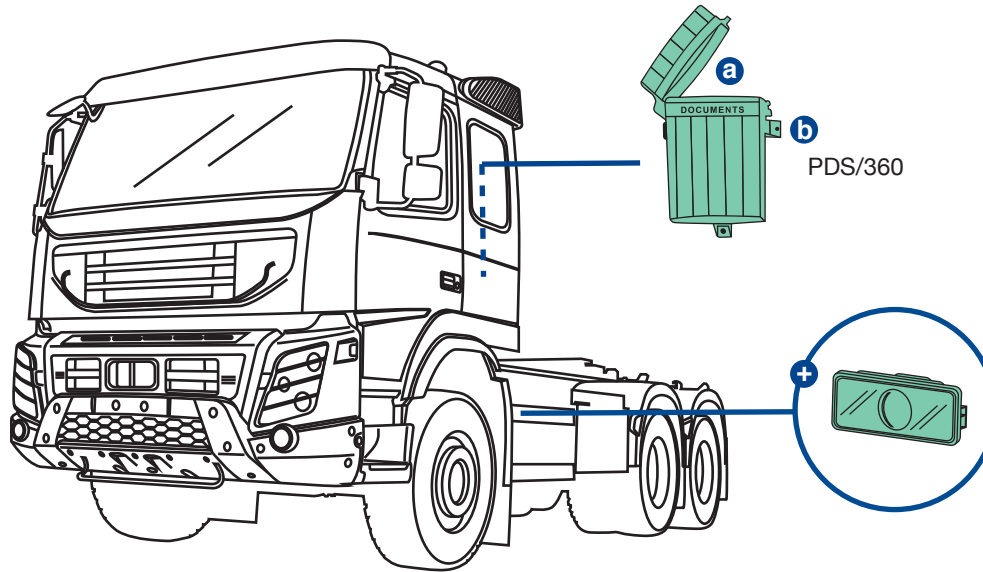

PDS/360

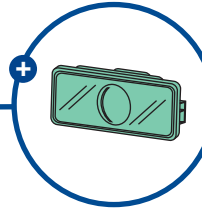

2FH/610
d|s-rh|lh-rechts|links

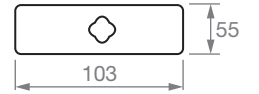

PDS/360

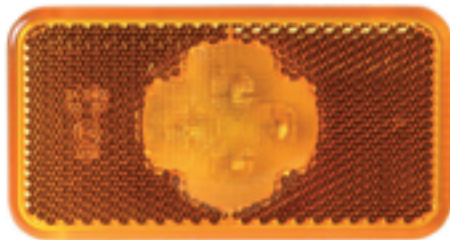
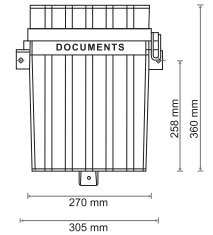

2FH/610
O.E.M. 20789440



PDS/360
O.E.M. -

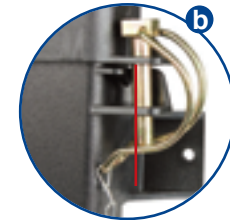

FMX Euro 5

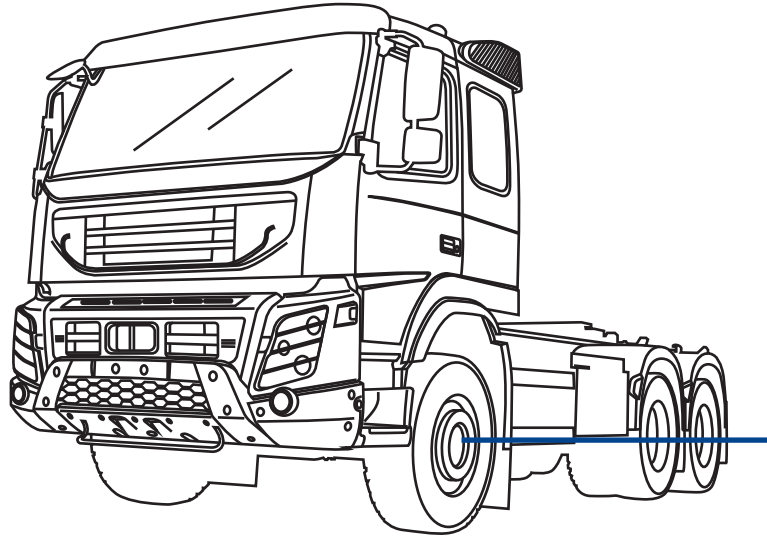

PRM/700
d|s-rh|lh-rechts|links
PRM/710
d|s-rh|lh-rechts|links

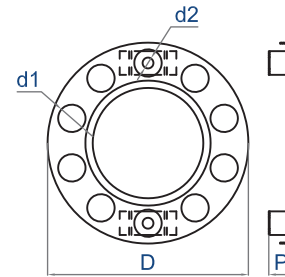

PRM/700 d|s-rh|lh-rechts+links

D ø 425 mm	P 40 mm
d1 nr. 10	d1 ø 58 mm
d2 nr. 2	d2 ø 24 mm
Ventilata	no-nein
Ventilated-Belüftet	
Colore	silver-silver-Silber
Colours-Farbe	
Materiale-Material	acciaio inox-stainless steel Edelstahl
Kg	1,700

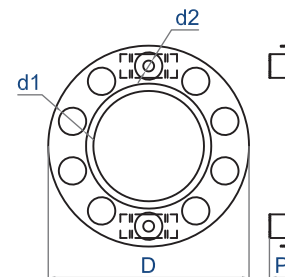

PRM/710 d|s-rh|lh-rechts+links

D ø 425 mm	P 40 mm
d1 nr. 10	d1 ø 58 mm
d2 nr. 2	d2 ø 24 mm
Ventilata	no-nein
Ventilated-Belüftet	
Colore	cromato-chrome-verchromt
Colours-Farbe	
Materiale-Material	acciaio inox-stainless steel Edelstahl
Kg	1,700



PRM/700
O.E.M. 22709903



PRM/710
O.E.M. -

gallery

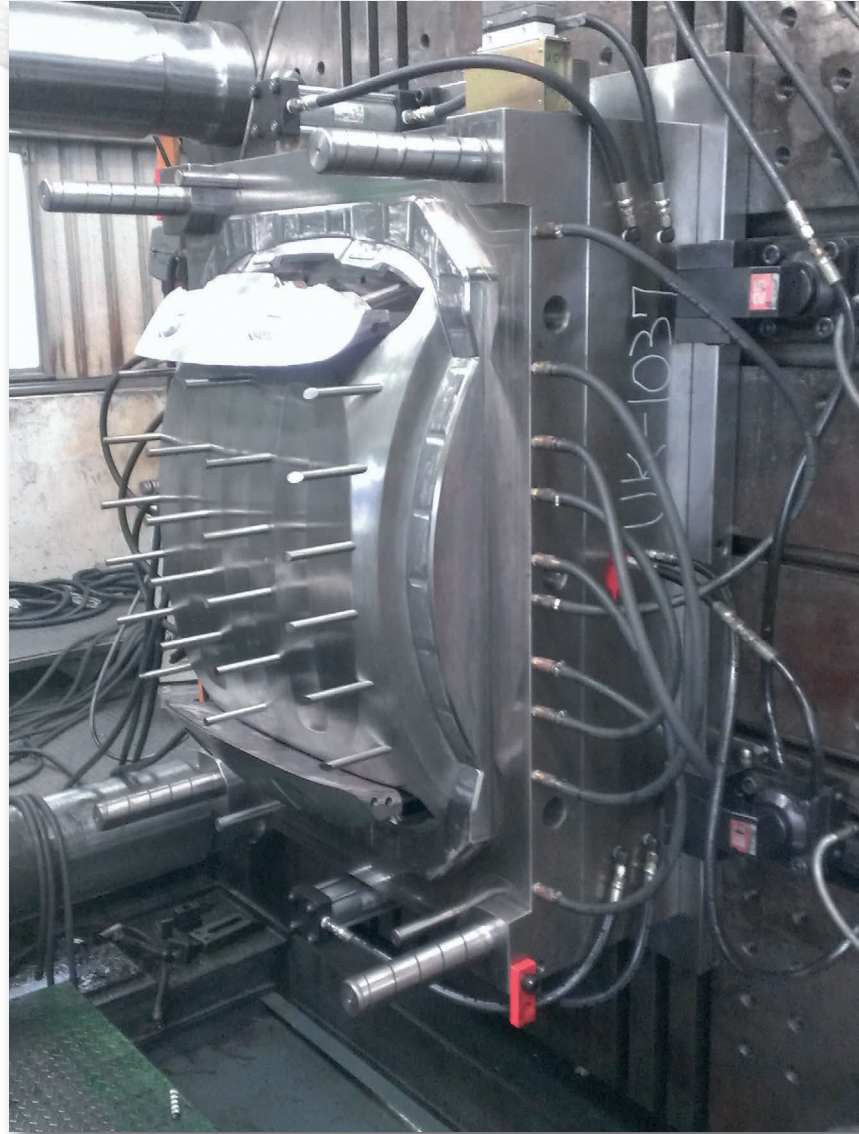

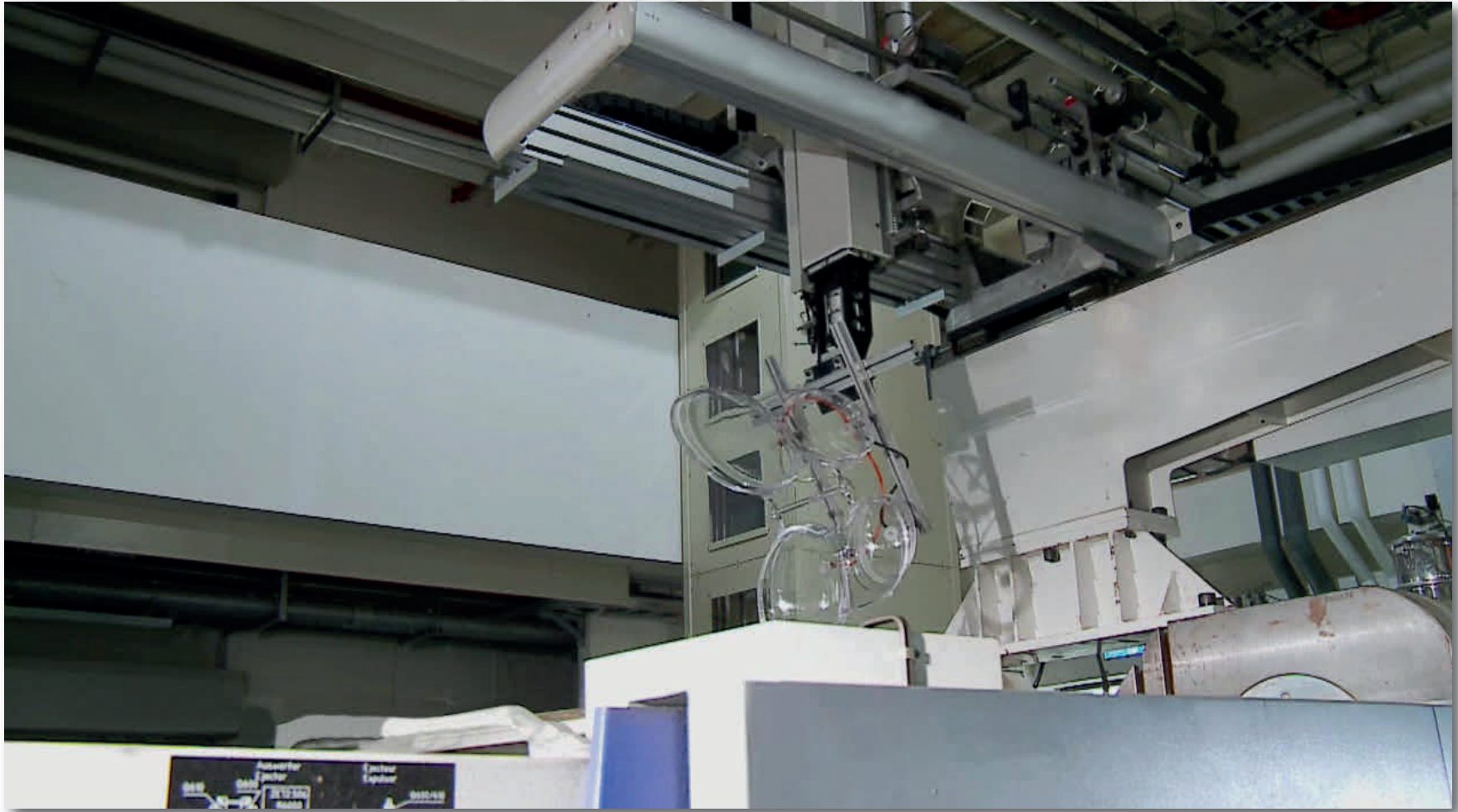

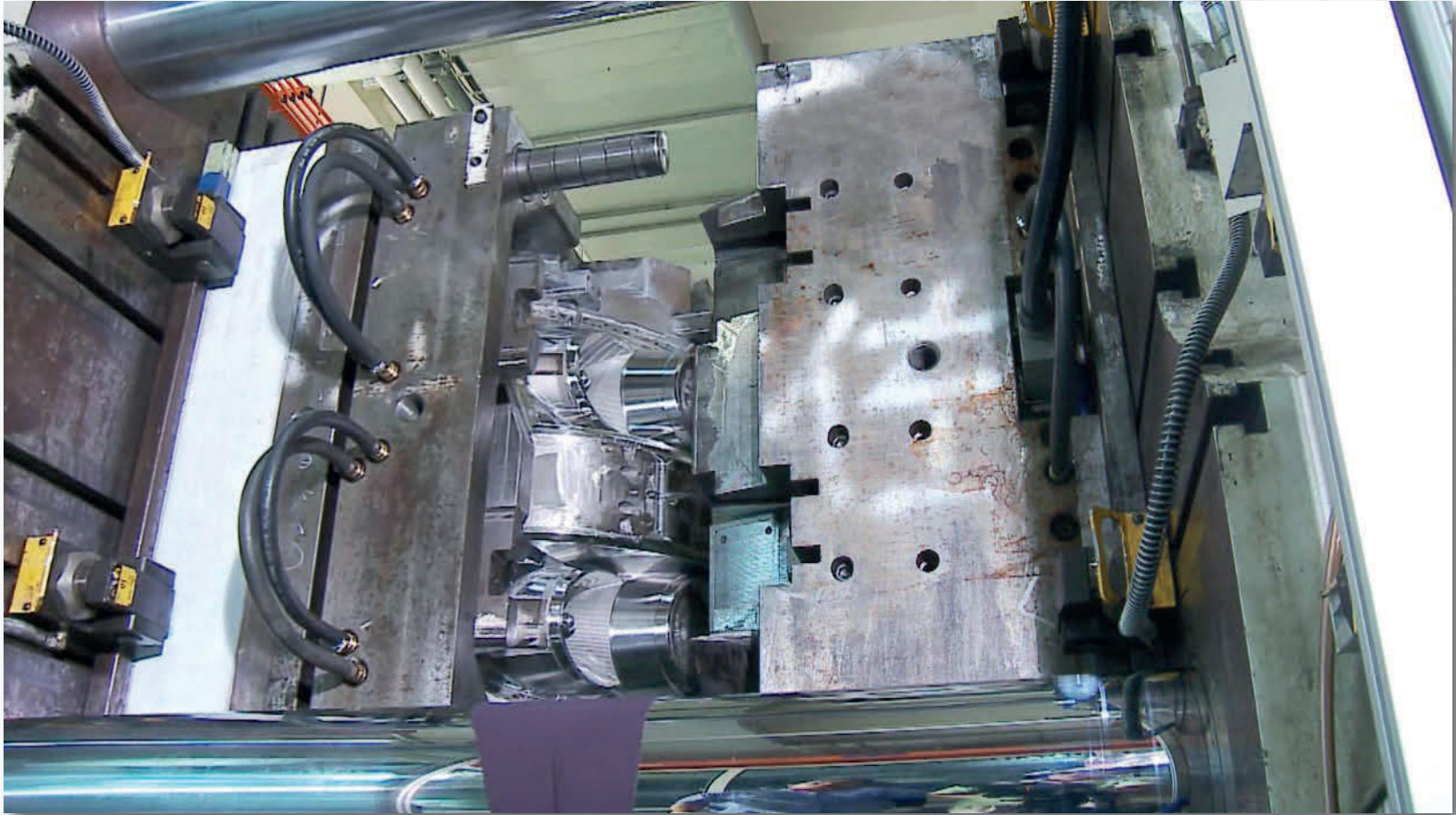

gallery





COVIND SPA

SERVIZIO VENDITE ITALIA DOMESTIC SALES DPT.

 +39 011 8965702

 +39 011 8965714

 +39 011 8965719

 +39 011 8965756

E.MAIL vendite@covind.it

SERVIZIO VENDITE ESTERO INTERNATIONAL SALES DPT.

 +39 011 8965722

 +39 011 8965735

 +39 011 8965759

 +39 011 8005149

E.MAIL export@covind.it

COVIND S.P.A.

Strada della Cebrosa, 68-70-72

10036 Settimo Torinese (TO) - ITALY

☎. +39 011 8965711

☎. +39 011 8977830

marketing@covind.it

www.covind.it



COVIND COV
IND COVIND
COVIND COV
IND COVIND
COVIND COV
IND COVIND
COVIND COV

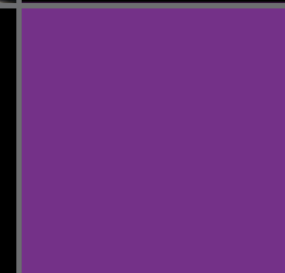
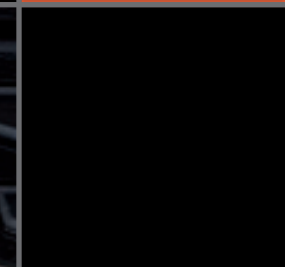

MOD7VOL04